

*Environmental Impact Assessment*  
**PROPOSED DOVECOT MEMORIAL PARK  
EXPANSION AT PART OF CHISHOLM  
CALLED BENDON PEN, ST. JOHNS ROAD,  
ST CATHERINE, JAMAICA**

---

*Report Version:* FINAL DRAFT

---

*Date:* September 2014

---

*Submitted by:*



---

*Submitted to:* NATIONAL ENVIRONMENT & PLANNING AGENCY

---

**ENVIRONMENTAL IMPACT ASSESSMENT FOR THE PROPOSED DOVECOT  
MEMORIAL PARK EXPANSION AT PART OF CHISHOLM CALLED BENDON PEN,  
ST. JOHNS ROAD, ST CATHERINE, JAMAICA**

*Submitted to:*

**KUMANDA PARK LIMITED**  
11 ½ - 13 Lindsay Crescent  
Kingston 10

*Submitted by:*

**C.L. ENVIRONMENTAL CO. LTD.**  
20 Windsor Avenue  
Kingston 5

**SEPTEMBER 2014**

## TABLE OF CONTENTS

TABLE OF CONTENTS .....	III
LIST OF FIGURES .....	VI
LIST OF TABLES .....	IX
LIST OF PLATES .....	XI
LIST OF APPENDICES.....	XII
LIST OF ACRONYMS.....	XIII
EXECUTIVE SUMMARY .....	XVI
<b>1.0 INTRODUCTION .....</b>	<b>1</b>
1.1 PROJECT CONTEXT.....	1
1.2 STUDY AREA .....	1
1.3 PROJECT RATIONALE.....	1
<b>2.0 POLICY, LEGAL AND ADMINISTRATIVE FRAMEWORK .....</b>	<b>3</b>
2.1 EIA FRAMEWORK .....	3
2.1.1 <i>Rationale and Basis</i> .....	3
2.1.2 <i>National Environment and Planning Agency</i> .....	3
2.1.3 <i>Permits and Licenses</i> .....	4
2.1.4 <i>EIA Components</i> .....	4
2.2 NATIONAL LEGISLATION .....	6
2.2.1 <i>Development Control</i> .....	6
2.2.2 <i>Environmental Conservation</i> .....	11
2.2.3 <i>Public Health &amp; Waste Management</i> .....	19
2.3 REGIONAL AND INTERNATIONAL LEGISLATIVE AND REGULATORY CONSIDERATIONS.....	21
2.3.1 <i>United Nations Convention on Biological Diversity</i> .....	21
2.3.2 <i>Convention on International Trade in Endangered Species of Wild Flora and Fauna (CITES)</i> .....	22
<b>3.0 COMPREHENSIVE DESCRIPTION OF THE PROPOSED PROJECT.....</b>	<b>23</b>
3.1 THE PROPONENT .....	23
3.2 HISTORY AND PROJECT BACKGROUND .....	24
3.3 PROJECT LOCATION.....	24
3.4 PROJECT COMPONENTS AND DESIGN.....	26
3.4.1 <i>Description</i> .....	26
3.4.2 <i>Water Supply and Sewage Disposal</i> .....	27
3.4.3 <i>Restrooms</i> .....	29
3.4.4 <i>Solid Waste</i> .....	29
3.4.5 <i>Drainage System</i> .....	34
3.4.6 <i>Site Access</i> .....	34
<b>3.4.7 <i>Equipment</i></b> .....	<b>34</b>
3.4.8 <i>Employment</i> .....	37
3.4.9 <i>Pest Control</i> .....	37

3.5	PROJECT PHASES AND SCHEDULE .....	37
<b>4.0</b>	<b>DESCRIPTION OF THE EXISTING ENVIRONMENT .....</b>	<b>39</b>
4.1	PHYSICAL.....	39
4.1.1	<i>Climatology and Meteorology</i> .....	39
4.1.2	<i>Ambient Particulates (PM 2.5 &amp; PM 10)</i> .....	40
4.1.3	<i>Ambient Noise Climate</i> .....	42
4.1.4	<i>Topography and Morphology</i> .....	54
4.1.5	<i>Geology and Soils</i> .....	60
4.1.6	<i>Surface Drainage</i> .....	63
4.1.7	<i>Hydrogeology</i> .....	67
4.1.8	<i>Natural Hazards</i> .....	70
4.1.9	<i>Water Quality</i> .....	76
4.2	BIOLOGICAL .....	80
4.2.1	<i>Flora</i> .....	80
4.2.2	<i>Fauna</i> .....	87
4.2.3	<i>Ecological Carrying Capacity</i> .....	90
4.3	SOCIAL .....	90
4.3.1	<i>Demography, Services and Infrastructure</i> .....	90
4.3.2	<i>Cultural and Archaeological</i> .....	111
4.3.3	<i>Land Use and Zoning</i> .....	125
4.3.4	<i>Aesthetics</i> .....	131
<b>5.0</b>	<b>PUBLIC PARTICIPATION AND CONSULTATION .....</b>	<b>138</b>
5.1	PURPOSE OF THIS SECTION OF THE EIA.....	138
5.2	STAKEHOLDER CONSULTATION PROGRAMME.....	138
5.3	ISSUES RAISED.....	139
5.3.1	<i>Community Stakeholders</i> .....	139
5.3.2	<i>Other Stakeholders</i> .....	139
5.4	INDEX OF TECHNICAL RESPONSES TO STAKEHOLDER ISSUES IN THE EIA .....	141
5.5	COMMUNITY CONSULTATION AND PERCEPTION .....	142
5.5.1	<i>Introduction</i> .....	142
5.5.2	<i>Results and Findings</i> .....	142
5.5.3	<i>Naseberry Grove</i> .....	143
5.5.4	<i>Dovecot</i> .....	144
5.5.5	<i>Mercury Gardens</i> .....	146
5.5.6	<i>Taylor Road</i> .....	147
5.5.7	<i>Bellevue Heights</i> .....	148
5.5.8	<i>Green Acres</i> .....	150
5.5.9	<i>Byles</i> .....	151
5.5.10	<i>Bendon</i> .....	153
5.5.11	<i>St Johns Heights</i> .....	155
5.5.12	<i>St Johns Meadows</i> .....	156
5.5.13	<i>Bellevue</i> .....	157



<b>6.0 IDENTIFICATION AND ASSESSMENT OF POTENTIAL DIRECT AND INDIRECT IMPACTS AND RECOMMENDED MITIGATION.....</b>	<b>159</b>
6.1 SITE PREPARATION AND CONSTRUCTION.....	165
6.1.1 <i>Physical</i> .....	165
6.1.2 <i>Biological</i> .....	172
6.1.3 <i>Human/Social/Cultural</i> .....	173
6.2 OPERATION .....	174
6.2.1 <i>Physical</i> .....	174
6.2.2 <i>Biological</i> .....	202
6.2.3 <i>Human and Social</i> .....	202
<b>7.0 CUMULATIVE ENVIRONMENTAL IMPACTS.....</b>	<b>204</b>
7.1 POST-DEVELOPMENT .....	204
7.1.1 <i>Extreme Rainfall Runoff</i> .....	204
7.1.2 <i>Groundwater Quality</i> .....	206
7.1.3 <i>Transportation</i> .....	206
<b>8.0 RESIDUAL IMPACTS .....</b>	<b>207</b>
8.1 SITE PREPARATION AND CONSTRUCTION .....	207
8.1.1 <i>Air Quality</i> .....	207
8.1.2 <i>Traffic</i> .....	207
8.1.3 <i>Heritage and Cultural</i> .....	207
8.2 OPERATION.....	207
8.2.1 <i>Noise</i> .....	207
8.2.2 <i>Groundwater Quality</i> .....	207
8.2.3 <i>Socio-Economic</i> .....	208
<b>9.0 IDENTIFICATION AND ANALYSIS OF ALTERNATIVES.....</b>	<b>209</b>
9.1 ALTERNATIVE 1 – THE “NO-ACTION” ALTERNATIVE.....	209
9.2 ALTERNATIVE 2 – THE PROJECT AS PROPOSED .....	209
9.3 ALTERNATIVE 3 – USE OF PROPOSED SITE FOR RESIDENTIAL PURPOSES.....	210
9.4 ALTERNATIVE 4 – USE OF PROPOSED SITE FOR BUILDING A SCHOOL.....	211
9.5 ALTERNATIVE 5 – USE OF PROPOSED SITE FOR CATTLE REARING .....	211
9.6 ALTERNATIVE 6 – RELOCATION OF PROPOSED EXPANSION TO THE IMMEDIATE NORTH OF THE EXISTING DOVECOT CEMETERY .....	211
9.7 THE PREFERRED ALTERNATIVE.....	212
<b>10.0 ENVIRONMENTAL MONITORING AND MANAGEMENT.....</b>	<b>213</b>
10.1 SITE CLEARANCE AND PREPARATION PHASE .....	213
10.2 CONSTRUCTION PHASE.....	214
10.3 OPERATIONAL PHASE .....	215
10.4 REPORTING REQUIREMENTS .....	215
10.4.1 <i>Water Quality</i> .....	215
<b>11.0 GLOSSARY OF TECHNICAL TERMS.....</b>	<b>217</b>

A .....	217
B .....	217
C .....	217
D .....	218
E .....	219
F .....	220
G .....	220
H .....	221
I .....	222
L .....	222
M .....	223
N .....	223
O .....	223
P .....	224
R .....	225
S .....	225
T .....	227
U .....	228
V .....	228
W .....	228
<b>12.0 REFERENCES .....</b>	<b>230</b>
<b>13.0 APPENDICES .....</b>	<b>233</b>

## LIST OF FIGURES

Figure 2-1	Development Order Areas in Jamaica .....	8
Figure 2-2	Protected animals in Jamaica .....	13
Figure 2-3	Map showing forest estates across the island, including reserves, crowned lands, private areas and NWC lands.....	16
Figure 2-4	Protected Areas system in Jamaica .....	18
Figure 3-1	Location of proposed expansion site.....	25
Figure 3-2	Schematic of a typical vault plan .....	26
Figure 3-3	Schematic of a typical vault section .....	27
Figure 3-4	Layout of the proposed Dovecot expansion depicting the locations of the restrooms and tile field	30
Figure 3-5	The location of the lower rest room showing the septic tank, the flow from septic tanks 2 and 3 and the evapotranspiration bed .....	31
Figure 3-6	Schematic showing the layout of the evapotranspiration bed.....	32

Figure 3-7 Plan view of the male restroom ..... 33

Figure 3-8 Plan view of the female restroom ..... 33

Figure 3-9 Front elevation of the typical restroom building ..... 33

Figure 3-10 Proposed layout of the Dovecot expansion project ..... 35

Figure 3-11 Storage shed views ..... 36

Figure 3-12 Proposed phased clearing of the site ..... 38

Figure 4-1 Map showing noise and particulate sampling locations ..... 41

Figure 4-2 Noise fluctuation (Leq) over 72 hours at Station 1 ..... 44

Figure 4-3 Octave band spectrum of noise at Station 1..... 45

Figure 4-4 L10 and L90 for Station 1 ..... 46

Figure 4-5 Noise fluctuation (Leq) over 72 hours at Station 2 ..... 46

Figure 4-6 Octave band spectrum of noise at Station 2..... 47

Figure 4-7 L10 and L90 for Station 2 ..... 48

Figure 4-8 Noise fluctuation (Leq) over 72 hours at Station 3 ..... 48

Figure 4-9 Octave band spectrum of noise at Station 3..... 49

Figure 4-10 L10 and L90 for Station 3 ..... 50

Figure 4-11 Noise fluctuation (Leq) over 72 hours at Station 4 ..... 50

Figure 4-12 Octave band spectrum of noise at Station 4..... 51

Figure 4-13 L10 and L90 for Station 4 ..... 52

Figure 4-14 Noise fluctuation (Leq) at Station 5..... 52

Figure 4-15 Octave band spectrum of noise at Station 5..... 53

Figure 4-16 L10 and L90 for Station 5 ..... 54

Figure 4-17 Topographic profile NW-SE (see Figure 4-18 for profile location)..... 55

Figure 4-18 General topography of the region ..... 56

Figure 4-19 Slope map of the study area ..... 57

Figure 4-20 Drainage and topographic features of the property ..... 59

Figure 4-21 Geology Map (based on 1:50,000 Geological Map Series Metric Edition, MGD)..... 62

Figure 4-22. Existing drainage features contiguous to the site ..... 63

Figure 4-23. Layout of the development superimposed on the Ministry of Agriculture Soils map of Jamaica..... 64

Figure 4-24 SCS 24-hour Rainfall Distributions..... 66

Figure 4-25. Hydrostratigraphy map of Jamaica, Source: WRA ..... 68

Figure 4-26 Location of the project area relative to the hydrostratigraphic units in St. Catherine ..... 69

Figure 4-27 Elevations of the water table varying from high to low moving from the hills in the north to the plains on the south..... 70

Figure 4-28	Prevailing hurricane tracks in the Atlantic Basin .....	72
Figure 4-29	Tropical Cyclones from 1842 to 2012 within 50nm of the proposed development. (Track label: name of the storm, year – month).....	73
Figure 4-30	Tropical Cyclones per month within a 50nm (92.6km) radius.....	73
Figure 4-31	Earthquakes in Jamaica from 1977 to 2014.....	75
Figure 4-32	The location of the proposed area with 2km buffer and nearest wells.....	78
Figure 4-33	Survey Site for proposed expansion of Dovecot Memorial Park, indicated in red. Transect line indicated in green running north to south across the designated area.....	81
Figure 4-34	Density per unit area of overall stems for the 12 most abundant species in the study area	83
Figure 4-35	Seedling abundance for the 15 most common species in the study area .....	84
Figure 4-36	Sapling abundance for the 18 most common species in the study area.....	85
Figure 4-37	Graph showing proportion of stems recorded in the study area .....	85
Figure 4-38	Map showing the Social Impact Area (SIA).....	92
Figure 4-39	Male and female percentage population by age category for the SIA in 2011 .....	94
Figure 4-40	Comparison of dependency ratios for the year 2011.....	95
Figure 4-41	SIA 2001 and 2011 population data represented in enumeration districts .....	96
Figure 4-42	Proportion of persons in poverty in each community .....	98
Figure 4-43	Percentage population attaining a secondary education within the SIA.....	100
Figure 4-44	Percentage of housing units by type within the SIA.....	101
Figure 4-45	Percentage households by source of lighting .....	102
Figure 4-46	Percentage dwelling with electricity within the SIA for the year 2011 .....	103
Figure 4-47	Health and emergency services located in and around the SIA .....	107
Figure 4-48	Average hourly traffic flow for west bound traffic along St. John’s road west of Featherbed Lane.....	108
Figure 4-49	Average hourly traffic flow for east bound traffic along St. John’s road west of Featherbed Lane	109
Figure 4-50	Road network and infrastructure located in the SIA.....	110
Figure 4-51	The Island of Jamaica in 1814-1840 with St. John parish outlined in red .....	112
Figure 4-52	Historic 1763 map showing settlement in the proposed development area .....	113
Figure 4-53	Historic map of 1804 showing location of Chisholm’s .....	114
Figure 4-54	Extract from Harrison’s map of 1881 showing sub division of Chisholm’s Run.....	115
Figure 4-55	Harrison Map showing locations of stables outlined in yellow .....	120
Figure 4-56	Extract of Harrison Map Showing J. R .Peeke owning lands abutting Bendon Pen....	121
Figure 4-57	Land use within the SIA .....	128
Figure 4-58	St Catherine Coastal Development Order map.....	129

Figure 4-59 - Map showing Land Use of Highway 2000 Corridor Development (Portmore to Clarendon Park)..... 130

Figure 4-60 Proposed landscape plan for the Dovecot cemetery expansion..... 132

Figure 4-61 Viewshed from Green Acres from the ground floor (left) and on the second floor (right) 133

Figure 4-62 Viewshed from Mercury Gardens from the ground floor (left) and on the second floor (right) 134

Figure 4-63 Viewshed from Naseberry Grove from the ground floor (left) and on the second floor (right) 135

Figure 4-64 Viewshed from Bendon from the ground floor (left) and on the second floor (right).. 136

Figure 4-65 Viewshed from St. Johns Heights from the ground floor (left) and on the second floor (right) 137

**Figure 6-1 Soils Map of the wider Kitson town and Paul Mountain area surrounding the site ..... 171**

Figure 6-2 Triangulated Irregular Network (TIN) projected from the Digital elevation model (DEM). 181

Figure 6-3 Calculated head values for the project area determined by MODFLOW..... 185

Figure 6-4 Zones of influence of the wells in proximity to the proposed development..... 186

Figure 6-5 Operational TOC concentrations (1 year) due to runoff infiltrating project site..... 189

Figure 6-6 Operational TOC concentrations (10 years) due to runoff infiltrating project site..... 189

Figure 6-7 Operational NH3 concentrations (1 year) due to runoff infiltrating project site..... 191

Figure 6-8 Operational NH3 concentrations (10 years) due to runoff infiltrating project site..... 191

Figure 6-9 Operational Calcium concentrations (1 year) due to runoff infiltrating project site. .... 193

Figure 6-10 Operational Calcium concentrations (10 years) due to runoff infiltrating project site. . 193

Figure 6-11 Operational sulphate concentrations (1 year) due to runoff infiltrating project site..... 196

Figure 6-12 Operational sulphate concentrations (10 years) due to runoff infiltrating project site. 196

Figure 6-13 Operational iron concentrations (1 year) due to runoff infiltrating project site..... 198

Figure 6-14 Operational iron concentrations (10 years) due to runoff infiltrating project site..... 198

Figure 6-15 Operational phosphorus concentrations (1 year) due to runoff infiltrating project site. 200

Figure 6-16 Operational phosphorus concentrations (10 years) due to runoff infiltrating project site. .... 200

Figure 7-1 Locations of Rainfall stations obtained from Met office of Jamaica ..... 204

Figure 7-2 Overall increase in 24-hours rainfall intensity for the period between 1988 and 2009. 205

**LIST OF TABLES**

Table 1-1 Public cemeteries in St. Catherine and their status ..... 1

Table 2-1 Draft national ambient marine water quality standards for Jamaica, 2009..... 19

Table 3-1 Water Demand per day for workers and for Irrigation shown across 5 of the 12 phases of the development .....	28
Table 3-2 Daily Wastewater generation estimate for the development.....	28
Table 4-1 Particulate and Noise sampling locations (coordinates shown are in JAD 2001) .....	40
Table 4-2 PM 10 Results.....	42
Table 4-3 PM 2.5 Results.....	42
Table 4-4 Comparison of noise levels at the stations with the NEPA guidelines.....	54
Table 4-5 Percolation rates obtained from two test pits on site.....	65
Table 4-6 Comparison of the peak runoff from the site for the existing and post development condition .....	66
Table 4-7 Comparison of the total 24hr rainfall runoff from the site for the existing and post development condition .....	67
Table 4-8 Tropical Cyclones (1842 - 2012) within 50nm (92.6km) radius of the proposed development.....	74
Table 4-9 PGA, 0.2s SA and 1.0s SA for the Proposed Development Area .....	76
Table 4-10 Location of wells within 2km radius of the proposed development .....	76
Table 4-11 Historical water quality data for Green Acres well .....	79
Table 4-12 Invertebrate fauna recorded at study site.....	88
Table 4-13 List of bird species observed from conducted counts and transect.....	89
Table 4-14 Age categories as percentage of the population for the year 2011.....	93
Table 4-15 Comparison of population densities for the year 2011 .....	95
Table 4-16 Population 3 years old and over by highest level of educational attainment as a percentage, for the year 2011.....	99
Table 4-17 Percentage of households by water supply for the year 2011 .....	104
Table 5-1 Inventory of Responses to some Stakeholder Issues.....	141
Table 6-1 Impact assessment criteria for potential environmental impacts .....	160
Table 6-2 Impact matrix for site preparation and construction phases of cemetery .....	161
Table 6-3 Impact matrix for operation phase of cemetery.....	163
Table 6-4 – Typical construction equipment noise levels .....	165
<b>Table 6-5 Comparison of the peak runoff from the site for the existing and post development condition .....</b>	<b>169</b>
<b>Table 6-6 Comparison of the total 24hr rainfall runoff from the site for the existing and post development condition .....</b>	<b>169</b>
Table 6-7 Typical elemental component of a 70kg human body. Source: (Environment Agency, 2004) .....	179
Table 6-8 Potential contaminant release (kg) from a single 70kg burial. Source: (Environment Agency, 2004).....	180

Table 6-9 Material properties implemented within the MODFLOW model .....	182
Table 6-10 Recharge values used within the calibration of the MODFLOW model.....	182
Table 6-11 Comparison of observed head at selected wells versus heads determined by MODFLOW .....	184
Table 6-12 Rainfall data for stations in proximity to project area .....	187
Table 6-13 Affected wells and their respective contaminant concentrations after 10 years.....	188
Table 6-14 Affected wells and their respective contaminant concentrations after 10 years.....	190
Table 6-15 Affected wells and their respective contaminant concentrations after 10 years.....	197
Table 7-1 Overall increase in 24-hours rainfall intensity for the period between 1988 and 2009 ..	205

## LIST OF PLATES

Plate 4-1 Weather station deployed atop Bendon Seventh Day Adventist Church (Station 1)....	39
Plate 4-2 Photo showing particulate sampler deployed .....	40
Plate 4-3 Deployment of noise meter .....	43
Plate 4-4 Edge of Sinkhole #1 (a) and Karst Pipe (b).....	60
Plate 4-5 Excavation and profile of Pit #2 .....	61
Plate 4-6 Vegetation cover of the area .....	116
Plate 4-7 Two (of many) paths found within the proposed area of development.....	116
Plate 4-8 Piece of Taino pottery shard in situ in burnt out charcoal kiln.....	117
Plate 4-9 Boundary markers.....	118
Plate 4-10 Foundations of recently demolished structures .....	119
Plate 4-11 Bricks in the vicinity of historic stable .....	119
Plate 4-12 Tombs and headstone found in graveyard.....	121
Plate 4-13 Trough (one of) that was found in the proposed development area .....	122
Plate 4-14 Bowl Shards, Earthenware Taíno, 650-1500 A.D .....	123
Plate 4-15 Bowl Shards, Earthenware African Jamaican, 1670-1835 A.D.....	123
Plate 4-16 Bottle Shard, Brown Salt glazed Stoneware, English, 1720 -1800 A.D.....	123
Plate 4-17 Cylindrical wine bottle shard, Olive Green Glass, English, 1735-1830 A.D .....	123
Plate 4-18 3 piece mould Cylindrical wine bottle shard, Olive Green, English, 1749-1840 A.D.....	123
Plate 4-19 Bowl shards, Cream ware, English, 1762-1820 A.D.....	123
Plate 4-20 Cooking pot shard, Iron African-Jamaican, 18th -19th C.....	124
Plate 4-21 Pharmaceutical Bottle Horses Indian Root Pill, Brown Glass, Jamaican, 20th C.....	124
Plate 4-22 Flower Pot shard, Earthenware, African Jamaican, 20th C .....	124

Plate 4-23 Floor Tile, Earthenware, 20th C..... 124  
Plate 4-24 Figurine handle shard, Porcelain, 20th C ..... 124  
Plate 4-25 Bendon Seventh Day Adventist Church ..... 126  
Plate 4-26 Area cleared of all vegetation for use as coal kiln. Bottom right- A stack of the typical size stems used for charcoal production in this area..... 126  
Plate 4-27 Disposal of garbage on proposed property ..... 127

**LIST OF APPENDICES**

Appendix 1 – Terms of Reference ..... 234  
Appendix 2 – Study Team..... 246  
Appendix 3 – NEPA Guidelines for Public Participation ..... 247  
Appendix 4 – QC-10 Noise Calibration Certificate ..... 255  
Appendix 5 – Flora species listing ..... 256  
Appendix 6 – WRA Technical Note..... 264  
Appendix 7 – Questionnaires ..... 273



## LIST OF ACRONYMS

<b>A</b>	AA DT	Annual average daily traffic
	ACGIH	American Conference of Industrial Hygienists
	AMC	Antecedent moisture conditions
	amsl	Above mean sea level
<b>B</b>	BA	Basal area
<b>C</b>	C	Celsius
	CBD	Convention on Biological Diversity
	CCCL	Caribbean Cement Company Limited
	CDMP	Caribbean Disaster Mitigation Project
	CN	Curve number
	CO	Carbon Monoxide
	CO <sub>2</sub>	Carbon Dioxide
	<b>D</b>	DAFOR
	dBA	A-weighted sound level (decibel)
	DBH	Diameter at breast height
	DEM	Digital elevation model
	DO	Dissolved oxygen
<b>E</b>	E	East/ Easting
	EIA	Environmental Impact Assessment
	EMP	Environmental Monitoring Programme
	ESRI	Environmental Systems Research Institute
	FHA	Federal Highway Administration
	FOG	Fats Oil and Grease
<b>F</b>	ft	Feet
<b>G</b>	g/l	Grams per litre
	GIS	Geographic information system
	GOJ	Government of Jamaica
	GPS	Global Positioning System
<b>H</b>	HA	Hectares
	hr	Hour
	Hz	Hertz
<b>I</b>	IPCC	Intergovernmental Panel on Climate Change
	IUCN	International Union for Conservation of Nature
<b>J</b>	JAD 2001	Jamaica Grid 2001
	JGQ	Jamaica Gypsum and Quarries Limited
	JNHT	Jamaica National Heritage Trust
<b>K</b>	km	Kilometre
<b>L</b>	LDUC	Land Development and Utilization Commission
	Leq	Time-average sound level
	Lj	jth sound level
<b>M</b>	m	Metre

	m/s	Metres per second
	m <sup>3</sup> /sec	Cubic metres per second
	mg/l	Milligrams per litre
	mg/m <sup>3</sup>	Milligrams per cubic metre
	min	Minute (s)
	mm	Millimetre
	mm/24 hr	Millimetres per 24 hour period
	mS/cm	milli Siemens per cm
	MSDS	Material Safety Data Sheets
<b>N</b>	N	North/ Northing
	NAAQS	National Ambient Air Quality Standards
	NEPA	National Environment and Planning Agency
	NMIA	Norman Manley International Airport
	NO <sub>2</sub>	Nitrogen Dioxide, Nitrite
	NO <sub>3</sub>	Nitrate
	NO <sub>x</sub>	Nitrogen Oxides
	NRCA	Natural Resources Conservation Act
	NSWMA	National Solid Waste Management Authority
	NTU	Nephelometric turbidity units
	NWA	National Works Agency
	NWC	National Water Commission
<b>O</b>	ODPEM	Office of Disaster Preparedness and Emergency Management
	OSHA	Occupational Safety and Health Administration
<b>P</b>	PCQ	Point-Centred Quarter
	PEL	Hearing Conservation and Permissible Exposure Limit
	PIF	Project Information Form
	PM <sub>10</sub>	Particulate matter smaller than 10 microns in diameter, respirable particulate matter
	PM <sub>2.5</sub>	Particulate matter smaller than 2.5 microns in diameter, fine particulate matter
	ppm	parts per million
	ppt	parts per thousand
<b>Q</b>	QSP II	Quest suite Professional II
<b>S</b>	s	Second
	SCS	US Soil Conservation Service
	SIA	Social Impact Area
	SO <sub>2</sub>	Sulfur Dioxide, sulfite
	SO <sub>4</sub>	Sulfate
	SO <sub>x</sub>	Sulfur Oxides
	STATIN	Statistical Institute of Jamaica
<b>T</b>	TCP Act	Town and Country Planning Act
	TDS	Total dissolved solids
	TSS	Total Suspended Solids

	TCL	Trinidad Cement Limited
<b>U</b>	USEPA	United States Environmental Protection Agency
<b>W</b>	WHO	World Health Organization
	WRA	Water Resources Authority
<b>Y</b>	yr	Year

# EXECUTIVE SUMMARY

## INTRODUCTION

The proposed project is an expansion of the Dovecot Memorial Park off St. Johns Road in St Catherine and is being undertaken by Kumanda Park Limited. A 2km radius of the proposed expansion was delineated as the study area. This distance was chosen as it encompasses the major residential areas in proximity and also wells that could potentially be impact by the proposed development. The residential areas include the western section of St. John's West community (western Spanish Town), parts of the Kitson Town community, settlements of Old Road, Naseberry Grove, Byles, St. John's Heights, Bellevue Heights, Green Acres and Johnston Pen.

The property to be developed will cover 28.7 ha (71 acres). It is separated from the current Dovecot Cemetery by a parochial dirt road and a small settlement which from part of Bendon Pen district. The area is generally flat and devoid of any limestone out-cropping with soils that appear to be deep.

It has become critical to expand the existing Dovecot Memorial Gardens as the current area used for burials has run out of space. Customers are complaining that due to the limited space available they are not able to choose a location that they deem ideal for their loved ones and funerals are too close together in proximity. Dovecot Memorial Park is one of the main cemeteries that serve persons in the parishes of Kingston & St. Andrew and St. Catherine. It is for these reasons why it has become imperative that the existing Dovecot Memorial Gardens be expanded.

## COMPREHENSIVE DESCRIPTION OF THE PROPOSED PROJECT

Kumanda Park Limited has been registered company in Jamaica since 1991. Its registered office is located at 11 ½ - 13 Lindsay Crescent, Kingston 10. It has the responsibility of overseeing the management of the Dovecot properties for Madden's. Madden's have branches in Lucea, Montego Bay, Constant Spring Road, the casket production company, situated at Norman Road and Head Office on North Street. The complete funeral service is offered by Madden's. This includes choosing the type of funeral service and the location.

Dovecot was originally owned by Victor Morris which features 53 acres (21.4 ha) of extensive lawns with flat headstones, based on a concept developed in the United States. He operated Dovecot for 2 ½ years before deciding to migrate and sell the property in 1977. It was at this time that an agreement was reached with Madden's for the sale of the property located at St. John's Road, near Spanish Town, St. Catherine. Dovecot (St. Catherine) accommodates an average of 1,500 burials annually for the past 12 years.

With the Pye River Cemetery in Montego Bay rapidly running out of space, Dovecot St. James was created and opened in 2004 and has accommodated an average 400 burials per year. The proposed expansion of the Dovecot Memorial Garden (St. Catherine) will allow for burials to occur for an approximate 48 years based on current average rate of burials.

### **Project Location**

The proposed development is located in Chisholm Bendon Pen, St. Catherine, Jamaica. It is situated about 80 meters above sea level, approximately 500 metres west of the current Dovecot Memorial Park, a kilometre north of Bellevue Heights, about 6.5 kilometres west from Spanish Town along St. Johns Road and contiguous to Naseberry Grove to the south.

### **Project Description**

The proposed project is an expansion of operation for the Dovecot Memorial Park on St. Johns Road in St. Catharine. It is intended that the 71 acre (28.7 hectares, 0.29 km<sup>2</sup>) property is to be developed to accommodate 48,120 burial vaults ( $\approx$  15.7 ha) and sanitary facilities (225 m<sup>2</sup>). The existing Bendon Seventh Day Adventist church will remain and 17,520 m<sup>2</sup> of internal road ways will be put in place as the main artery of the property. The proposed Dovecot expansion (28.7 ha) will be larger than the existing cemetery which has an area of approximately 21.4 ha.

The expected number of vaults to be created as a result of this expansion is 48,120 of which 50% will be single vaults and the other 50% will be double vaults. With a land area of 28.7 ha, the burial density is 1,676.65 vaults per hectare.

The typical vault layout will be 2.34 m long, 0.84 m wide and 1.52 m deep (92" x 33" x 60").

### **Water Supply and Sewage Disposal**

The National Water Commission (NWC) supplies the existing site with potable water and sewage is presently managed with septic tanks and an absorption pit.

The proposed sewage treatment for the new expansion is by septic tank and evapotranspiration bed. Sewage will be collected from the three (3) restroom areas with initial treatment provided by septic tanks at each set of restrooms. The effluent from the two higher (in elevation) restrooms septic tanks will be conveyed by pipes down to the lowest restroom where it will connect into the outlet pipe from the septic tank there. The total effluent flow from the three (3) septic tanks will then enter the adjacent evaporation bed via a distribution box for final treatment and disposal. The effluent from the septic tank system will pass through a distribution network in a specially prepared mass of suitable sand and gravel layers. The effect of capillary action and shallow rooting perennial plants will result in the loss of effluent by evapotranspiration. The bed allows for storage of excess effluent during periods of low evapotranspiration, acting like a sponge, while the convex surface encourages the shedding of a

proportion of the rainfall. The bed is lined at the bottom and sides with a synthetic liner which prevents any seepage of effluent into the soil below. A 15m x 15m evapotranspiration bed will be used.

It is anticipated that water demand will come from two main sources; these are the bathrooms/showers and the irrigation areas. The estimated water demand is based on a per capita usage by staff (30) and an estimated 1000 visitors per day as well as the irrigation requirements per acre for grass (California State Water Resources Control board, 1984). The total required volume of water required per day is estimated at 1,334m<sup>3</sup>/d on average when the full 12 phases are realized.

It is anticipated that the production of wastewater will be primarily domestic, i.e. from the bathrooms. The generation of the wastewater will be primarily from the staff and daily visitors attending funerals in the park. The estimated total wastewater flows to be generated is therefore in the order of 20.9 m<sup>3</sup>/day (5,521 us gal/day). The evapotranspiration system recommended for this area is reasonably sized based on the available design data. Detailed drawings specifications in terms of the beds and their lining to prevent leakage, the specific plant types and spacing required for the maximum uptake should all be done prior to final approval by the EHU/NEPA.

### **Solid Waste**

Solid waste generation during cemetery operations will mainly include food and beverage refuse from funeral goers who purchase from any local vendors on the property.

Garbage receptacles will be strategically placed around the cemetery grounds and along the access roads. They will be adequately designed and covered to prevent access by vermin and minimise odour. Staff members will be designated to empty contents of the garbage receptacles into a central garbage skip easily accessible by the NSWMA garbage truck. Disposal of the contents of the skip will be done at an approved disposal site (Riverton Landfill).

### **Drainage**

The proposed project will maintain the existing natural drainage conditions. Hardscape areas such as roads and parking lot will capture surface water via curbs and channels and deposit in soak wells or sinkholes.

### **Site Access**

The proposed site will be accessed from St. Johns Road in proximity to the existing Bendon Seventh Day Adventist Church. From there, clients will be able to drive to the required burial locations by using the road network laid out. There is a proposed service entrance to the northern side of the property.

## **Equipment**

The equipment needed for the efficient running of the cemetery include an excavator, a frontend loader, weed wackers, lawnmowers and machetes. The excavator and frontend loaders will be used for the construction of the grave whilst the weed wackers, lawnmowers and machetes used for the maintenance of the lawns and verges. They will be used on an as needed basis. Equipment will be stored towards the northern boundary of the site.

## **Employment**

The preparation of the land and burial sites will provide employment for approximately 30 persons broken down into 18 persons for site preparation (e.g. excavator operator, bushing etc.) and 12 masons for the preparation of the vaults.

## **Project Phasing and Scheduling**

Once approved, the project will commence by the creation of the parking area, roads, drainage and sewage system and the clearance of approximately 1.2 ha (=3 acres) for the development of burial plots. This phase is expected to take 6-8 months after the necessary loans are secured.

After the initial phase, the land will be cleared at approximately 1.2 ha (=3 acres) at a time until the entire area is used up. It is anticipated as stated above, that the entire project will have a lifespan of approximately 48 years. It is envisioned that the site will be cleared in 12 phases.

During the construction of the graves site clearance will occur which will remove dirt and vegetation (including trees). The top soil and smaller vegetation (mulch/conditioner) will be set aside to be reused in landscaping while the larger trees will be given to charcoal burners in the area to be used.

## **DESCRIPTION OF THE EXISTING ENVIRONMENT**

### **Physical**

#### **Climate and Meteorology**

Average temperature over the monitoring period was 24.6 °C and ranged from a low of 18.4 °C to a high of 32.2 °C. Average relative humidity was 80.1% and ranged from a low of 44% to a high of 98%. Average wind speed was 0.6 m/s and ranged from a low of 0 m/s to a high of 9.4 m/s. Dominant wind direction was from the north northeast. Measurable precipitation during the monitoring period was 37.1 mm, with the two major rain days being March 8<sup>th</sup> (23.9mm) and March 15<sup>th</sup> (10.2mm). Barometric pressure ranged from a low of 1000.2 millibar to 1008 millibar,

### Ambient Particulates

For the PM 10 sampling event all locations had average particulate values compliant with the 24-hour US EPA standard of  $150\mu\text{g}/\text{m}^3$ . Values ranged from  $19.72\mu\text{g}/\text{m}^3$  at Station P2 to  $23.84\mu\text{g}/\text{m}^3$  at Station P3. For the PM 2.5 sampling event all locations had average particulate values compliant with the 24-hour US EPA standard of  $35\mu\text{g}/\text{m}^3$ . Values ranged from  $7.41\mu\text{g}/\text{m}^3$  at Station P2 to  $24.95\mu\text{g}/\text{m}^3$  at Station P1.

### Ambient Noise

Two out of the five stations had daytime and night time noise levels non-compliant with NEPA noise guidelines.

### Topography and Morphology

The proposed cemetery is located in a NW-SE oriented valley on the southern edge of the limestone plateau which is bordered to the SE by the alluvial plain of the Rio Cobre River. Except for the sudden changes of elevation at the beginning and the end, the valley has a fairly flat longitudinal profile between 90 and 60m a.m.s.l. with slopes of less than 5%. All this suggest that its morphology is mainly structurally controlled.

Two (2) small sinkholes with a diameter of about 50m are located on the North Western side of the ridge. The sinkhole #1 is a distinct circular depression formed by karst (solution) processes in the North Western flank of the ridge. The limestone rocks exposed in the floor of the depression and in the near-vertical, 3m high half-circular outcrop in flank of the ridge, show numerous small solution features including open karst pipes with diameters of up to 50cm. The sinkhole is clearly free draining and appears to have a high hydraulic conductivity. Sinkhole #2 on the other hand does not have visible solution features or even limestone outcrops. The depression is completely covered with soil and vegetation, has gentle sloping edges and a maximum depth of approximately 3m. Although rainfall did occur at the time of the fieldwork, no standing water or even wet muddy areas were observed in the depression, indicating good internal drainage. While Sinkhole #2 is reported to overflow on occasions into sinkhole #1, the surface drainage channel linking the two sinkholes is barely traceable. This indicates that the overflow is not a normal event and confirms that depression is a sinkhole and not merely a retention pond.

The runoff coming out of the hills to the Northwest and Northeast of the development are channelized respectively by the Kitson Town main road and the unpaved Dovecot Cemetery road. The runoff channel along the unpaved Dovecot Cemetery road, the main drainage channel in the area, is reported to have caused flooding of the settlements along the road. The property however does not contribute runoff of any significance to this drainage channel. There are no significant drainage channels traversing the property and while there are several shallow closed depression on the property, there is no apparent problem with stagnant water either.



Finally it should be mentioned that in addition to the natural occurring depressions there are seven (7) pits on the property which were excavated with backhoe or bulldozer to a depth of 2 to 3m. They are located near the intersection of the two unpaved road that cross the property and show up in the slope map as areas of high relief.

### Geology and Soils

Limestone bedrock is exposed in the low ridge on the south-eastern border of the property and in the foot of the escarpment at the northern end of the property. Except for Sinkhole #1, all outcrops are small and are partially covered by a thin soil layer. The outcrop in Sinkhole #1 consists of hard, white sparite and microsparite. The rocks are affected by karst processes including brecciation and partially recrystallization. Part of the outcrop shows some bedding. The bedding has a spacing of 10 to 40 cm and dips 15 degrees to the SSE. The unconfined compressive strength of the limestone at the surface is estimated to range from 55 to 103MPa (8,000 to 15,000psi). Although the typical Walderston Formation deposits consist generally of soft chalky limestone, the hardness of the rocks both within the exposure site of sinkhole # 1 and in the many small surface exposures on the ridge is not just caused by case hardening but appears to be a consistent feature of the deposit throughout the exposed limestone ridge.

The seven (7) pits near the intersection of the two unpaved roads on the property show that the St. Ann Clay loam soil cover is very thick here. All seven (7) pits were dug to a depth of 2.5 to 3 meter without a sign of the underlying limestone bedrock. In an attempt to determine the depth to the bedrock, two of the existing pits were further excavated with a backhoe to a depth of 5m but the bedrock was not reached. The same uniform red clayey silt beginning from just below 5cm thick organic layer at the surface was found all the way to the bottom of the excavation without any indication that the bedrock was nearby.

### Surface Drainage

The site lies in an area that is can be described as a storm water catchment area. It is also an area where groundwater recharge occurs through sinkhole on the property as well as near to the property. Site visits indicate that storm water flows from the wider catchment area and enters the site at various locations; these include various sections along the length of the western boundary and the south-western corner of the boundary along St. Johns Road. Storm water flows in the wider are and the site are generally directed by the terrain and storm drains to sinkholes. Two sinkholes were identified onsite whereas another two (sinkhole 3&4) were identified offsite and within 500m of the project boundaries. The storm water flows from the hills to the west of the site cross the western site boundary and unto the site where they are intercepted by the sinkholes (1&2). Flows further north of the site generally travel along the "Dovecot Cemetery Road" via an earthen swale and a concrete drain before discharging to sinkhole 4. Residents living in the are indicated that the area surrounding sinkhole 4 is prone to flooding whenever the sinkhole is overwhelmed of gets blocked.

The estimated peak runoff from the existing site is estimated to be in the order of 2.25m<sup>3</sup>/s from the 2 yr event to 6.24m<sup>3</sup>/s for the 100 year event. Similarly, the overall runoff for a 24hr storm will vary from 14,568 cubic metres to 40,350 cubic metres per day for the 2 to 100 year return storm.

### Hydrogeology

The project site is located just above the southern foothills of the Paul Mountain range in central St. Catherine, just above the starting of the Liguanea plains which extends all the way to the southern coastline and to the Hellshire hills. There is a general flow of groundwater in this area is towards the south in this region, from the limestone aquifers in/below the mountains to the alluvium aquifers in the south. The levels of the aquifers were determined from well logs obtained from the WRA's online database. The logs indicate the water table is high in the limestone aquifers in the north and falls off sharply down to the plains in the south where the slopes are less steep. The water table below the project site is in the order of 45 to 50 metres above mean sea level (msl) whereas the site elevation is in the order of 80 metres above msl. The groundwater flow in this location according to the WRA hydrostratigraphy map moves in a southerly direction. This is consistent with the natural gradient which is setup between the mountains in the north and the plains and sea in the south.

### Natural Hazards

Jamaica is located in the southern section of the Atlantic Hurricane belt. The hurricane season begins officially on the 1<sup>st</sup> of June and ends on the 30<sup>th</sup> of November. A compilation of the prevailing Hurricane tracks for the North Atlantic basin illustrates that Jamaica is most likely to be affected by a hurricane in the month of August, September and October. In total, forty-six (46) tropical cyclones passed between 1842 and 2012 within a 92.6km (50nm) radius of the proposed development. This includes 5 tropical depressions, of which 3 developed farther into hurricanes. On average one (1) tropical storm or greater occurred every 4.2 years and one (1) hurricane every 7.4 years. A major hurricane, (that is a category 3 hurricane or greater) passed every 28.5 year within a 92.6km (50nm) of the proposed development.

Jamaica is located on the border between Gonave micro-plate and Caribbean tectonic plate and is therefore subjected to significant seismic activity and earthquakes. The proposed development is located on the south eastern edge of the Clarendon block, west of the Wagwater Fault Zone. While the epicentre density and magnitudes indicates that this area is a less seismically active than the Plantain Garden fault area north of Kingston, the energy released by a major earthquake on the Plantain Garden fault, the Wagwater Fault zone, or any of the other faults has the potential to cause major damage at the proposed development area.

### Water Quality

Water quality testing was not feasible as there are no surface water bodies within 500 m of the site. The 500 m guideline is intended to provide protection against worst-case scenarios in which a cemetery is sited upstream of a production well and on geological formation that functions as an

aquifer. Testing water quality in the nearest point in the irrigation canal south of the site is unlikely to yield information that would allow for better environmental management as it is too far away (>2.3km), and affected by many sources. The proposed expansion area is situated within a residential area and west of Dovecot Cemetery.

Twelve (12) wells are located within 2km of the proposed development. The closest wells are the Naseberry Grove wells (>250m North West), Bellevue Co-op well (~1.5km South), Bellevue well (~1.5km east) and Green Acres well (~1.5km east). However, the area is situated on a limestone aquifer which is permeable and has high pollution vulnerability. The groundwater flow direction is southerly and thus a monitoring well should be placed at the southern end of the site.

## **Biological**

### **Flora**

The vegetation of the site is highly disturbed; dominated by shrubs and saplings below four meters in height. The canopy structure may be described as short and open (only a few canopies touching), with few mature trees greater than five meters in height. The upper canopy (trees > 4 meters) is dominated by Wild Star-apple, Logwood and fruit trees such as mango that have been spared removal over time. The lower canopy is dominated by *Haematoxylum campechianum*, *Chrysophyllum oliviforme*, and species of *Acacia*, *Casearia* and *Eugenia*. The understory where present is thick and closed, and dominated by vines, shrubs, grass (e.g. *Lasiacis divaricta*) and seedlings of *Haematoxylum campechianum* and *Chrysophyllum oliviforme*. There is a disproportionately large quantity of saplings and seedlings, compared to a small number of trees represented in the canopy.

The area is highly disturbed with very few trees over 10 cm DBH. Sources of disturbance include areas cleared for coal kiln, trees removed for use as charcoal as fence posts, numerous trails used to access the resources within the area. During the 'walk through' 15 areas recently or currently been used as coal kilns were recorded. As a result of these disturbances, the canopy layer is short (3-6 m) and open. Due to constant tree removal it is unlikely that large trees will dominate and that the canopy will reach heights greater than 7m (mean 3.1 m). The vegetation within the area sampled was recorded as trees and shrubs; shrubs included: true shrubs, vines and grasses.

### **Fauna**

Twenty nine species of invertebrates were recorded. These include six species of beetles, nine species of butterflies. Two of Jamaica's three species of scorpions were also recorded; these were the two native species (the other was introduced) and both have a very wide distribution across the island. No species of special conservation significance was recorded.

A total of 21 bird species were observed. The breakdown is as follows:

- 4 Endemics
- 3 Endemic Subspecies
- 13 Residents
- 1 Summer Resident

A few mongooses were observed; this was not surprising given the proximity of human habitation. No frogs were recorded; this is one of the driest parts of Jamaica and low population of frogs is expected. The only lizard observed was *Anolis lineatopus*, the common tree lizard.

### Ecological Carrying Capacity

Ecological Carrying Capacity can be defined as the ability of the system to maintain the current species population size and dynamics (these are the interactions between flora and fauna in a given area). The proposed project area consists of a highly disturbed system under constant anthropogenic stress. The system does however support several plant species and a limited number of faunal species. The shift in land use and resultant change in habitat may potentially have an impact the carrying capacity of the surrounding areas. Due to the disturbed and stressed nature of the proposed project area and surrounding areas, the increased stress on resources (space, food availability and other niche requirements) is expected to be minimal. The surrounding areas may become more vulnerable to manmade stresses such as charcoal burning, farming and animal husbandry. This may in turn affect/reduce the actual carrying capacity of the surrounding lands over time. The greatest impact is anticipated to be the impact on the livelihoods of persons who use the proposed project site for charcoal burning activities and animal husbandry.

### Human and Social

#### Demography

The total population within the 2km Social Impact Area (SIA) in 2011 was approximately 7,788 persons (STATIN 2011 Population Census). Examination of the 2001 population data showed that there were approximately 6,159 persons within the 2 km radius of the proposed development area in 2001. From this population, and that calculated for the year 2011 (7,788 persons), it was estimated that the actual growth within the SIA between 2001 and 2011 was approximately 2.37% per annum. Based on this growth rate, at the time of this study (2014), the population was approximately 8,356 persons and is expected to reach 15,026 persons over the next twenty five years if the current population growth rate remains the same.

The segment of a population that is considered more vulnerable are the young (children less than five years old) and the elderly (65 years and over). In the SIA population, approximately equal numbers for each category were considered vulnerable, wherein 7.4% comprised the young category and 7.9%, the 65 years and older category.

The child dependency ratio for the SIA in 2011 was 412.3 per 1000 persons of labour force age; old age dependency ratio stood at 121.5 per 1000 persons of labour force age; and societal dependency ratio of 533.9 per 1000 persons of labour force. This indicates that the youth (child dependency) are far more dependent on the labour force for support when compared with the elderly. Comparisons of the child dependency ratios at varying extents indicate that the child dependency ratio for the study area (SIA) were higher than the national and regional figures

The land area within the SIA was calculated to be approximately 17.23 km<sup>2</sup>. With a population of 7,788 persons, the overall population density was calculated to be 452 persons/km<sup>2</sup>. This population density is considerably higher than the national level (245.5 persons/km<sup>2</sup>), and also higher than the St. Catherine regional density of 433.6 persons/km<sup>2</sup> (Table 4-15). As mentioned previously, a number of residential developments are located within the SIA, such as Green Acres, Bellevue Heights, St. Johns Heights and Johnston Pen; this justifies the relatively high population density calculated.

### Education

When educational attainment within the SIA is calculated as a percentage, it becomes evident that there is a propensity towards the attainment of a primary and secondary school education. Forty four percent of the SIA population attained a secondary school education, followed by 32.9% attaining a primary education. Secondary educational attainment is comparable to the Jamaica and St. Catherine figures (45.7% and 44.7% respectively).

There are higher percentages of those attaining a university or other tertiary level in the SIA (12.9%) when compared to the national combined total of 9.9% for Jamaica. Statistics for pre-primary and no education are similar amongst all extents examined. The relatively high proportion of the population in proximity to the project location attaining a secondary education, as well as tertiary education suggests that the labour pool is relatively educated, and as such, there should be no problem in obtaining non-technical workers from the community. No schools are found within the 2 km buffer SIA; the closest schools in proximity to the proposed location are situated approximately 3 km west (Kitson Town All Age) and 3.5 km east (Cassava River and Friendship Primary) and northwest (Paul Mountain All Age) of the proposed site.

### Housing

There were 2,429 housing units within the SIA in 2011. Approximately 98.3% of the housing units in the SIA were of the separate detached type, 0.8% were attached, 0.5% were improvised units and 0.5% residents did not report the type of housing unit

### Infrastructure

The percentage of households using kerosene as their main means of lighting in the SIA (1.2%) was lower than the Jamaican level (5.5%), as well as the parish extent (4.0%). Data for all extents (SIA, parish and national) comprised over 90% of households, with the SIA having a higher percentage

(96.9%) than the parish and country level (93.6% and 91.9% respectively). Other means of lighting were comparable for all extents and were below 1.0% of households.

The National Water Commission (NWC) is the public agency responsible for providing Jamaica's domestic water supply. Forty six percent (45.7%) of the households within the SIA received their domestic water supply from a public source, this is much lower than the national and parish levels (75.5% and 82.2% respectively). About 38.5% of the households in the SIA received trucked water, 13.3% from private sources, 1.6% from other sources, 0.1% from springs or rivers and 0.8% not report. The dissimilarity between percentage households receiving water from trucked sources in the SIA (38.5%) compared to the parish and national extents (3.7% and 2.1% respectively) is worth mentioning.

It is estimated that approximately 1,518,251.8 litres/day (~401,079.8 gals/day) of wastewater is generated within the study area (for 2014) and is expected to increase to 2,730,164.1 litres/day (~721,233.2 gals/day) over the next twenty five years based on calculated growth rates.

It is estimated that at the time of this study (2014), approximately 10,825.7 kg (~10.8 tonnes) of solid waste was being generated. The National Solid Waste Management Authority (NSWMA) is responsible for domestic solid waste collection within the study area and specifically, MPM Waste Management Ltd. covers the parish of St. Catherine. In residential areas, garbage is collected once per week. This service is provided free (partial covered by property taxes) for the households within the area. The waste is transported to the Riverton Waste Disposal Site (landfill) located in southeast St. Catherine, approximately 18 km east of the proposed development area. Riverton Waste Disposal Site is approximately 100 acres (40.5 ha). It receives approximately 60% of the islands waste. Solid waste collection for commercial and industrial facilities is done by arrangements by these entities with private contractors.

#### Communication

The parish of St. Catherine and the study area are served with landlines provided by LIME Jamaica Limited (formerly Cable and Wireless). Wireless communication (cellular) is provided by Digicel Jamaica Limited and LIME; a network to support internet connectivity is also provided by LIME and Flow.

Post offices are not found within the demarcated SIA; that found in Spanish Town is the closest to the proposed development area.

#### Health and Emergency Services

No health centres exist within the SIA; that closest to the proposed development area is the Kitson Town Health Centre, situated approximately 2.7 km west northwest of the development area. This health centre, along with others situated in the parish of St. Catherine (e.g. Sydenham and Spring Village) fall under the responsibility of the Southeast Regional Health Authority (SERHA).

There are currently no public or private hospitals within the SIA. Spanish Town Hospital is closest to the site and is located in Spanish Town, approximately 8.5 km east southeast of the proposed development area. Similar to the Kitson Town Health Centre, this hospital belongs to the Southeast Regional Health Authority. It is the largest 'Type B' Hospital in the island and services include medicine, surgery, urology, radiology, paediatrics, pathology, orthopaedics, laboratory and obstetrics and gynaecology.

The Spanish Town Fire Station is the closest fire station to the proposed development area and is situated outside the 2 km SIA, approximately 7.3 km east southeast of the proposed area. This station falls under Area III.

Police stations do not exist within the 2 km SIA surrounding the proposed development area. The closest station is Guanaboa Vale Police Station, situated about 5.7 km northwest of the project area. It is part of the Saint Catherine North division (Police Area Five).

#### Transportation

Air transport facilities do not exist within the SIA; the closest facilities are airfields, namely Caymanas Airfield, Marlie Hill Airfield and Bog Walk Airfield, situated between 10 and 15 km from the development area. The Norman Manley International Airport (NMIA) is the closest airport, approximately 27 km southeast of the development area. The NMIA is the primary airport for business travel to and from Jamaica and for the movement of air cargo. There are 13 scheduled airlines serving many international destinations and average daily aircraft movement is 67. In 2013, total passenger movements were approximately 1.37M and freight (cargo/mail) was 11,503 metric tonnes.

#### Cultural/Heritage

The Archaeology Division of Jamaica National Heritage Trust (JNHT) conducted an Archaeological Assessment on the proposed Dovecot Cemetery expansion. Historically, the property came of the holding called Chisholm Run which was divided into Naseberry Grove, Mount Hazard and Bendon Rest. Various ethnic groups including the Tainos have used the area as evidenced by the artefacts found. The property has seen various land uses over the past namely, the raising of race horses and cattle. The property is now in ruinate covered with dense secondary woodland punctuated by a variety of mango trees. Charcoal burning and small scale farming is the current economic activity. A grave yard with concrete graves and the remains of brick tombs were identified.

#### Community Perception

Approximately five percent (5.3%) of all respondents had heard of Kumanda Park Limited while 94.7% of respondents indicated they had never heard of Kumanda Park Limited.

75 % of respondents indicated that they heard of the company from other persons relaying information ("word of mouth"). As it related to respondents awareness of the proposal by Kumanda Park Limited



to expand the Dovecot Memorial Park, 47.4% of respondents were aware of the proposal and 52.6% of respondents were not aware. While it could not be quantified, it was realised that most of the respondents who indicated an awareness of the proposal to expand Dovecot, further indicated that they were not aware that it was being undertaken by Kumanda Park Limited.

On the issue of concerns 45.4% of respondents indicated that they had concerns about the project while 54.6% of respondents indicated that they had no concern. 40.1% of interviewees indicated that they did not anticipate the project affecting their lives in any way; 24.3% of respondents were uncertain about whether or not the project would affect their lives. 9.2% of interviewees expected a positive effect on their lives as a result of the project while 26.3% of respondents indicated they expected their lives to be negatively affected. Concerns that were highlighted included the proximity of the cemetery to residences and the expected depreciation

31.6% of those interviewed stated that they were aware of existing cemetery capacity being reached. When asked about if deaths occurred in their family, 90.1% of respondents confirmed that they had lost loved ones. Of this 90.1% of respondents 99.3% of respondents indicated that loved ones were interred at either family plots, private cemeteries or public cemeteries. 11.7% were interred at public cemeteries, 46.0 % at private cemeteries, 32.1% at family plots, 8.8% at both private cemeteries and family plots and 0.7% interred at public and private cemeteries.

When asked about whether or not they used the lands of the proposed site for any type of business/farming/residence 86.8% of those interviewed stated that they did not use the land for any type of activity.

When respondents were asked if they knew anyone who used the lands of the proposed site for any type of business/farming/residence 78.9% of respondents indicated that they did not know anyone who used the land.



## IMPACTS AND MITIGATION

### SITE PREPARATION AND CONSTRUCTION

Impact	Mitigation
Noise Pollution	<ul style="list-style-type: none"> <li>• Use equipment with low noise emissions as stated by manufacturer, and fitted with noise reduction devices such as mufflers</li> <li>• Operate noise-generating equipment during regular working hours (e.g. 7am – 7pm) to reduce potential of creating noise nuisance at night</li> <li>• Construction workers operating noise-generating equipment should be equipped with noise protection (ear muffs, ear plugs)</li> </ul>
Air Quality	<ul style="list-style-type: none"> <li>• Areas should be dampened every 4-6 hours or within reason to prevent a dust nuisance, and on hotter days this frequency should be increased</li> <li>• Minimize cleared areas to those that are needed to be used</li> <li>• Cover or wet construction materials such as marl</li> <li>• Where unavoidable, construction workers working in dusty areas should be provided and fitted with N95 respirators</li> </ul>
Solid Waste Generation	<ul style="list-style-type: none"> <li>• Skips and bins should be strategically placed within the campsite and construction site, and adequately designed and covered to prevent access by vermin and minimise odour</li> <li>• The skips and bins at both the construction campsite and construction site should be emptied regularly to prevent overfilling</li> <li>• Disposal of the contents of the skips and bins should be done at an approved disposal site</li> </ul>
Wastewater Generation/Disposal	<ul style="list-style-type: none"> <li>• Provide portable sanitary conveniences for the construction workers for control of sewage waste. A ratio of approximately 25 workers per chemical toilet should be used</li> <li>• Showers should be provide for workers</li> </ul>
Storage of Raw Material/Equipment	<ul style="list-style-type: none"> <li>• A central area should be designated for the storage of raw materials. This area should be lined in order to prevent the leakage of chemicals into the sediment.</li> <li>• Raw materials that generate dust should be covered or wet frequently to prevent them from becoming air or waterborne</li> <li>• Fine grained materials (sand, marl, etc.) will be stockpiled away from drainage channels and low berms will be placed around the piles which themselves will be covered with tarpaulin to prevent them from being eroded and washed away</li> <li>• Raw material and equipment should be placed on hardstands surrounded by berms to contain any accidental surface runoff</li> </ul>

Impact	Mitigation
	<ul style="list-style-type: none"> <li>• Bulk storage of fuels and oils should be in clearly marked containers (tanks/drums etc.) indicating the type and quantity being stored. In addition, these containers should be surrounded by berms to contain the volume being stored in case of accidental spillage.</li> </ul>
Transport of Raw Material/Equipment	<ul style="list-style-type: none"> <li>• Paths of the planned roadways should be used, rather than creating temporary pathways just for equipment access.</li> <li>• Adequate and appropriate road signs should be erected to warn road users of the construction activities. For example reduced speed near the construction site.</li> <li>• Raw materials such as marl and sand should be adequately covered within the trucks to prevent any escaping into the air and along the roadway.</li> <li>• The trucks should be parked on the proposed site until they are off loaded.</li> <li>• Heavy equipment should be transported early morning (12 am – 5 am) with proper pilotage.</li> <li>• The use of flagmen should be employed to regulate traffic flow.</li> </ul>
Geology and Soils	<ul style="list-style-type: none"> <li>• Determine extent of sinkholes.</li> <li>• Maintain an appropriate setback from sinkholes for vault construction</li> </ul>
Runoff	<ul style="list-style-type: none"> <li>• The proposed project will maintain the existing natural drainage conditions. Hardscape areas such as roads and parking lot will capture surface water via curbs and channels and deposit in soak wells or sinkholes.</li> </ul>
Soil Erosion	<ul style="list-style-type: none"> <li>• Care should be taken not to dispose of debris in the existing drains.</li> <li>• Temporary drains inclusive of adequate silt basins must be installed to prevent flooding.</li> </ul>
Blockage of Sinkholes	<ul style="list-style-type: none"> <li>• Care should be taken not to dispose of debris in the sinkholes during site clearance.</li> <li>• Temporary sediment traps should be installed to prevent silt from the cleared areas getting into the sinkholes.</li> </ul>
Flora	<ul style="list-style-type: none"> <li>• Based on the classification of <i>Capparis babduca</i> and the number of stems that will be removed, it is recommended that this species be replanted.</li> <li>• <i>Capparis babduca</i> could be used in the landscaping of the new development.</li> </ul>
Traffic Management	<ul style="list-style-type: none"> <li>• Delivery trucks should operate ideally during off peak hours.</li> <li>• Loading of trucks as per NWA axel load guidelines.</li> <li>• Traffic diversion routes must be identified and constructed as necessary.</li> <li>• Adequate caution signage as per NWA guidelines and the use of flagmen where necessary.</li> <li>• Trucks must be properly covered and loaded so as to not let loose material fall during transport.</li> </ul>
Cultural and Historical	<ul style="list-style-type: none"> <li>• During site clearance, JNHT should be present in order to undertake further archaeological evaluations and ascertain the magnitude of Taíno sites, if any.</li> <li>• Ensure the preservation of the historic and cultural sites.</li> <li>• Monitoring should be conducted during clearing and excavation stages in areas where historic artefacts were discovered.</li> </ul>

Impact	Mitigation
	<ul style="list-style-type: none"> <li>The recording of impacted structures should be undertaken prior to destruction.</li> </ul>
Aesthetics	<ul style="list-style-type: none"> <li>Skips and bins should be strategically placed within the campsite and construction site.</li> <li>The skips and bins at the construction campsite should be adequately designed and covered to prevent access by vermin and minimise odour.</li> </ul>

## OPERATION

Impact	Mitigation
Noise Pollution	<ul style="list-style-type: none"> <li>Ensuring that equipment used are properly fitted with noise reduction devices such as mufflers.</li> </ul>
Wastewater Generation and Disposal	<ul style="list-style-type: none"> <li>The evapotranspiration beds must be lined to prevent leakage of the wastewater.</li> <li>Specific plant types and spacing are required for the maximum uptake within the beds.</li> </ul>
Solid Waste Generation	<ul style="list-style-type: none"> <li>Garbage receptacles should be strategically placed around the cemetery grounds and along the access roads.</li> <li>Garbage receptacles should be adequately designed and covered to prevent access by vermin and minimise odour.</li> <li>Disposal of the contents of the skips/bins should be done at an approved disposal site.</li> </ul>
Natural Hazards (Hurricanes and Earthquakes)	<ul style="list-style-type: none"> <li><i>Hurricanes</i> - Loss of essential services will affect the operation of the cemetery in case of a major hurricane but do not pose any environmental hazard that cannot be prevented by applying standard operational procedures.</li> <li><i>Earthquakes</i> - To mitigate for the risk it is recommended to maintain a buffer zone as was recommended in relation to the drainage. As a general recommendation the International Building Code, which has been incorporated in the local building code and which is expected to be enforced by the soon to be promulgated National Building Act, should be followed in the construction of the required infrastructure.</li> </ul>
Stormwater and Flooding	In general, it is recommended that the final drainage design of the development maintains and conforms to the following main drainage features of the property:

	<ul style="list-style-type: none"> <li>• All runoff northeast of the limestone ridge should be directed to the sinkholes.</li> <li>• A drainage channel or swale should be maintained between sinkhole#2 and sinkhole#1.</li> <li>• No construction should take in the footprint of sinkhole #1 and #2 and in the footprint of the drainage channel between the two sinkholes.</li> <li>• No assessment has been done to ascertain the capacity of the sinkholes. The capacity of the sinkhole needs to be assessed to determine if it can accommodate the additional flows (both peak and total runoff) without flooding the site or nearby developments.</li> <li>• It is recommended that sediment traps be installed in all drains leading to the sinkholes on the property to prevent them being blocked up over time.</li> <li>• Installation of berms and swale along the south-western border with the main road to prevent runoff entering the site from existing development. This flow will continue east and enter the gully system at the old racecourse south of the main road.</li> </ul>
Pollution of Aquifer	<ul style="list-style-type: none"> <li>• Minimize the use of chemicals in embalming and coffin preparation.</li> <li>• Encouraging more green burials.</li> <li>• Encourage more cremation and possibly prepare a location onsite for storing urns.</li> <li>• Have monitoring wells to the south and southeast of the property to monitor the water quality during the operational phase of the development. This should guide the rate at which the development proceeds over time.</li> <li>• Human or animal remains must not be buried within 250 metres of any well, borehole or spring from which a potable water supply is drawn.</li> <li>• The place of interment should be at least 30 metres away from any other spring or watercourse and at least 10 metres from any field drain.</li> <li>• All burial pits on the site must maintain a minimum of one metre of subsoil below the bottom of the burial pit (i.e. the base of the burial must be at least one metre above solid rock).</li> <li>• The base of all burial pits on the site must maintain a minimum of one metre clearance above the highest natural water table. (Any variability in the water table should be taken into account.)</li> <li>• Burial excavations should be backfilled as soon as the remains are interred, providing a minimum of one metre soil cover at the surface.</li> </ul>
Aesthetics	<ul style="list-style-type: none"> <li>• The cemetery grounds should be landscaped continually to enhance the feeling of serenity for mourning family members and friends attending funerals or visiting graves.</li> </ul>

	<ul style="list-style-type: none"><li>• Any large trees present in suitable areas (that will not interfere with vault areas) on site should remain so as to provide shading and improve overall aesthetics of the grounds. In this regard, <i>Capparis babduca</i> and existing shade trees should be used along with grass to landscape the grounds.</li><li>• Consideration should be given to earthen grave finishes with headstones or commemorative tree rather than the traditional concrete slabs.</li></ul>
--	---

# 1.0 INTRODUCTION

## 1.1 PROJECT CONTEXT

The proposed project is an expansion of the Dovecot Memorial Park off St. Johns Road in St Catherine and is being undertaken by Kumanda Park Limited.

## 1.2 STUDY AREA

A 2km radius of the proposed expansion was delineated as the study area. This distance was chosen as it encompasses the major residential areas in proximity and also wells that could potentially be impacted by the proposed development. The residential areas include the western section of St. John's West community (western Spanish Town), parts of the Kitson Town community, settlements of Old Road, Naseberry Grove, Byles, St. John's Heights, Bellevue Heights, Green Acres and Johnston Pen.

The property to be developed will cover 28.7 ha (71 acres). It is separated from the current Dovecot Cemetery by a parochial dirt road and a small settlement which form part of Bendon Pen district. The area is generally flat and devoid of any limestone out-cropping with soils that appear to be deep.

## 1.3 PROJECT RATIONALE

All the public cemeteries in St Catherine have reached or almost reached their capacities (Table 1-1). It has therefore become critical for additional burial spaces for the parish before the cemeteries become filled to their capacities. It is understood that the St. Catherine Parish Council has identified 10.1 ha of land (25 acres) in the Old Harbour area to construct a new public cemetery.

Table 1-1 Public cemeteries in St. Catherine and their status

	NAME OF CEMETERY	STATUS
1.	Spanish Town #5	Filled to capacity
2.	Church Pen	Almost at capacity
3.	Old Harbour Bay	Almost at capacity
4.	Lluidas Vale	Almost at capacity
5.	Commodore	Almost at capacity
6.	Treadways	Almost at capacity
7.	Harkers Hall	Almost at capacity

Jamaica has a crude death rate of 7.1 deaths /1000 population per year (STATIN 2011). St. Catherine has an estimated population of 527,449 persons in 2014 which is expected to increase to an estimated 631,064 persons in twenty five years. Assuming the national crude death rate applies to that regionally (St. Catherine), then it is estimated that there will be approximately 3,745 deaths per year which is expected to increase to 4,481 deaths per year in twenty five years. It is important to

note that the crude death rate indicator is significantly affected by age distribution. It will inevitably increase with the ageing of the population.

If the St. Catherine Parish Council establishes the proposed Old Harbour cemetery on the 10.1 ha (25 acres) of land, it is estimated that it will provide approximately 17,000 burial spaces (assuming 1,700 vaults/ha) or approximately 5 years of burial space if all deaths in St. Catherine are buried there.

The Development and Investment Manual outlines that new public cemetery provision shall be at a rate of 40 hectares for every 100,000 population. In the largest cities, between 40-70 hectares of land shall be allocated or reserved for cemetery (GOJ, 2007).

The criteria as outlined means that approximately that as of 2014 an estimated 211 – 369 ha of land should be provided as public cemeteries and that area is expected to increase to approximately 252 – 442 ha by 2039. The proposed provision of 10.1 hectares by the St. Catherine will be inadequate to meet this criteria. Therefore the shortfall has to be met by private developers. The proposed Dovecot expansion of 28.7 ha will help the parish council fulfil the criteria.

It has become critical to expand the existing Dovecot Memorial Gardens as the current area used for burials has run out of space. Customers are complaining that due to the limited space available they are not able to choose a location that they deem ideal for their loved ones and funerals are too close together in proximity.

Dovecot Memorial Park is one of the main cemeteries that serve persons in the parishes of Kingston & St. Andrew and St. Catherine. It is for these reasons why it has become imperative that the existing Dovecot Memorial Gardens be expanded.

This site was chosen based on six (6) main considerations:

1. Inadequate provision of public burial space.
2. The site is owned by the proposed developers.
3. The site is accessible.
4. There were no obvious issues related to environmental sustainability; and
5. The development would not breach any Development Order guidelines.
6. It is in keeping with the criteria in the Development and Investment Manual that there should be approximately 40 ha for every 100,000 population.

## 2.0 POLICY, LEGAL AND ADMINISTRATIVE FRAMEWORK

### 2.1 EIA FRAMEWORK

#### 2.1.1 Rationale and Basis

An Environmental Impact Assessment (EIA) is “a structured approach for obtaining and evaluating environmental information prior to its use in decision-making in the development process. This information consists, basically, of predictions of how the environment is expected to change if certain alternative actions are implemented and advice on how best to manage environmental changes if one alternative is selected and implemented” (Bisset, 1996).

The basis and rationale of an EIA has been summarised as follows<sup>1</sup>:

- Beyond preparation of technical reports, EIA is a means to a larger end - the protection and improvement of the environmental quality of life.
- It is a procedure to discover and evaluate the effects of activities on the environment - natural and social. It is not a single specific analytical method or technique, but uses many approaches as appropriate to the problem.
- It is not a science but uses many sciences in an integrated inter-disciplinary manner, evaluating relationships as they occur in the real world.
- It should not be treated as an appendage, or add-on, to a project, but regarded as an integral part of project planning. Its costs should be calculated as a part of adequate planning and not regarded as something extra.
- EIA does not ‘make’ decisions, but its findings should be considered in policy - and decision-making and should be reflected in final choices. Thus, it should be part of decision-making processes.
- The findings of EIA should focus on the important or critical issues, explaining why they are important and estimating probabilities in language that affords a basis for policy decisions.

#### 2.1.2 National Environment and Planning Agency

The National Environment and Planning Agency (NEPA) is the government executive agency and represent a merger of the Natural Resources Conservation Authority (NRCA), the Town Planning Department (TPD) and the Land Development and Utilization Commission (LDUC). Among the reasons for this merger was the streamlining of the planning application process in Jamaica. The Agency is moving towards one application to NEPA for new developments and new modifications that will review

---

<sup>1</sup> Wood, C., “Environmental Impact Assessment: A Comparative Review” p. 2. (from Caldwell, 1989, p.9)



and approve environmental aspects as well as planning, building control and zoning considerations. It is this agency that will review the Environmental Impact Assessment.

The National Environment and Planning Agency (NEPA) has been given responsibility for environmental management in Jamaica under the NRCA Act of 1991. Since the promulgation of the Act, the NRCA has been developing local standards. The Act was strengthened by supporting regulations, which became effective in January 1997. The underlying principles, which have been used in the development of the Act, are:

- The Polluter pays Principle
- The Cradle to Grave approach to waste management

### 2.1.3 Permits and Licenses

The Environmental Permit and License System (P&L) is administered by NEPA through the Applications Section. It was introduced in 1997 to ensure that all developments meet required standards and negative environmental impacts are minimized. Under the NRCA Act of 1991, the NRCA has the authority to issue, suspend and revoke environmental permits and licenses. An applicant for a Permit or License must complete a Permit Application Form (PAF) as well as a Project Information Form (PIF) for submission to the NRCA/NEPA.

### 2.1.4 EIA Components

#### 2.1.4.1 Process

The EIA Process is described below:

- The NRCA permit procedure is initiated by the submission of the Project Information Form (PIF) to the Authority. The PIF screening form is reviewed to determine whether an EIA is required and to begin determining areas of environmental significance, especially in waste discharge.
- Based on the review of the PIF, the NRCA advises if an EIA would be required for the proposed project and determines the scope of the EIA through proposed Terms of Reference (TORs). The TORs are proposed using NRCA guidelines and are ultimately approved by the NRCA. Appendix 1 gives the approved final TORs for the proposed project.
- The NRCA requires that the EIA include the following:
  - A description of the present environment, i.e. physical, biological and social environment. This includes, for example, consideration of economic situations, cultural heritage and ecological preservation;
  - A description of the significant impacts the environmental professionals expect the development to have on the environment, compared to the environment that would remain if there were no development. This will include indirect and cumulative impacts;
  - An analysis of alternatives that were considered in order to consider means of minimising or eliminating the impacts identified above; and

- An Environmental Management Plan, which includes a Monitoring & Hazard Management Plan and an Auditing schedule.
- The NRCA guidance on EIAs states that this process “should involve some level of stakeholder consultation in either focus groups or using structured questionnaires.” A draft EIA is submitted to the developer to solicit the proponents’ input into the description of the project (to check for accuracy of statements, and to enter into realistic discussions on the analysis of alternatives, as well as to inform the proponents of any other relevant legislation with which they must comply).
- Eleven copies of the finalised draft are then submitted to NRCA, two to the client, and the consultant keeps one (14 in all are produced). The NRCA distributes these to various other public sector institutions who sit on the Technical Committee (e.g. Water Resources Authority (WRA), Environmental Control Division in the Ministry of Health (ECD), Jamaica National Heritage Trust (JNHT)) for their comments. Typically this depends on the nature of the project.
- As deemed necessary by the NRCA, Public Meetings are then held, following the deposition of the Draft EIA at Parish Libraries (by the NRCA). A verbatim report of the public meetings is required, as well as a summary report of the main stakeholder responses which emerged.
- The comments of the NRCA, the other GOJ interests and the public are compiled and submitted in writing to the consultant not only for finalisation of the report, but for incorporation into the development’s design.
- The NRCA then reviews this report again, and if further clarifications are needed, these are again requested. Once the NRCA is satisfied, the EIA is submitted to the Technical Committee of the NRCA Board for final approval. If the EIA is not approved, the proponents may appeal to the Office of the Prime Minister.

#### **2.1.4.2 Public Participation**

There are usually two forms of public involvement in the EIA process. The first is direct involvement of the affected public or community in public consultations during the EIA study. These consultations allow the developer to provide information to the public about the project and to determine what issues the public wishes to see addressed. The extent and results of these consultations are included in the documented EIA report.

The second level of involvement is at the discretion of the NRCA and takes place after the EIA report and addendum, if any, has been prepared and after the applicant has provided the information needed for adequate review by NRCA and the public.

Community interaction and transparency is a critical area of focus for the success of this development and the second level of involvement described above is possible. Please see Appendix 3 for the NRCA reference document entitled “Guidelines for Public Participation” in EIAs.

## 2.2 NATIONAL LEGISLATION

EIAs are not only recommended in project design, but also required by Jamaican legislation. The following sections include a discussion of relevant national legislation, regulations/standards, policies and other material thought to be relevant to the proposed project. The following main areas are covered:

- Development Control: construction (including building codes and site management controls) and subsidiary inputs (quarry material, etc.), public safety and vulnerability to natural disasters
- Environmental Conservation: forestry, wildlife and biodiversity, protected areas and species, water resources, heritage and cultural resources.
- Public Health & Waste Management: air quality, noise levels, public health, solid waste, storm water, etc.

The roles of agencies with responsibility for implementing legal mechanisms are described where applicable.

### 2.2.1 Development Control

#### 2.2.1.1 *The Town and Country Planning Act (TCP Act) 1957 (Amended 1987)*

The Town and Country Planning Act (TCP Act) 1957 (Amended 1987) provides the statutory requirements for the orderly development of land through planning, as well guidelines for the preparation of Development Orders. A Development Order is a legal document which is used to guide development in the area to which it applies and the TCP Act is only applicable in an area where a Development Order exists. It constitutes land use zoning map/s, policy statements and standards relating to land use activities. The Development Order enables the Local Planning Authority and/or the Town and Country Planning Authority to regulate land developments within the area defined as the Development Order Area. Matters addressed in the order include:

- Roads
- Buildings and other structures
- Community Planning
- Amenities
- Public Services
- Transportation and Communications
- Miscellaneous

Other stipulations under the TCP Act are made for Advertisement Control Regulations, Petrol Filling Stations and Tree Preservation Orders. Tree Preservation Areas and Conservation Areas (as specified areas the gazetted Development Orders) are two types of protected areas associated this Act.

The TCP Act establishes the Town and Country Planning Authority, which in conjunction with the Local Planning Authorities (Parish Councils), are responsible for land use zoning and planning regulations as described in their local Development Orders. The TCP Act is administered by the National Environment and Planning Agency.

As seen in Figure 2-1, a Confirmed Development Order for the St. Catherine Coast exists and for which the TCP laws applies; however the proposed project does not fall within these boundaries. The proposed expansion area is within an urban area covered by development orders. The local planning authority for the development is the St. Catherine Parish Council. Continued proactive communication with the Parish Council is recommended in order to keep them informed and in dialogue on the activity in their jurisdiction. This will also be the approach of the environmental consulting team in deliberating environmental aspects of the planning and approval process.

#### **2.2.1.2 Parish Councils Act 1901 (Amended 2007)**

Under the Parish Council Act each Local Planning Authority may revoke or alter regulations concerning the construction and restrictions as to the elevation, size and design of buildings built with the approval of the relevant Minister. It may also make regulations concerning the installation of sewers on premises. As mentioned previously, the St. Catherine Parish Council is the local planning authority with responsible for development within the study area for the proposed project.

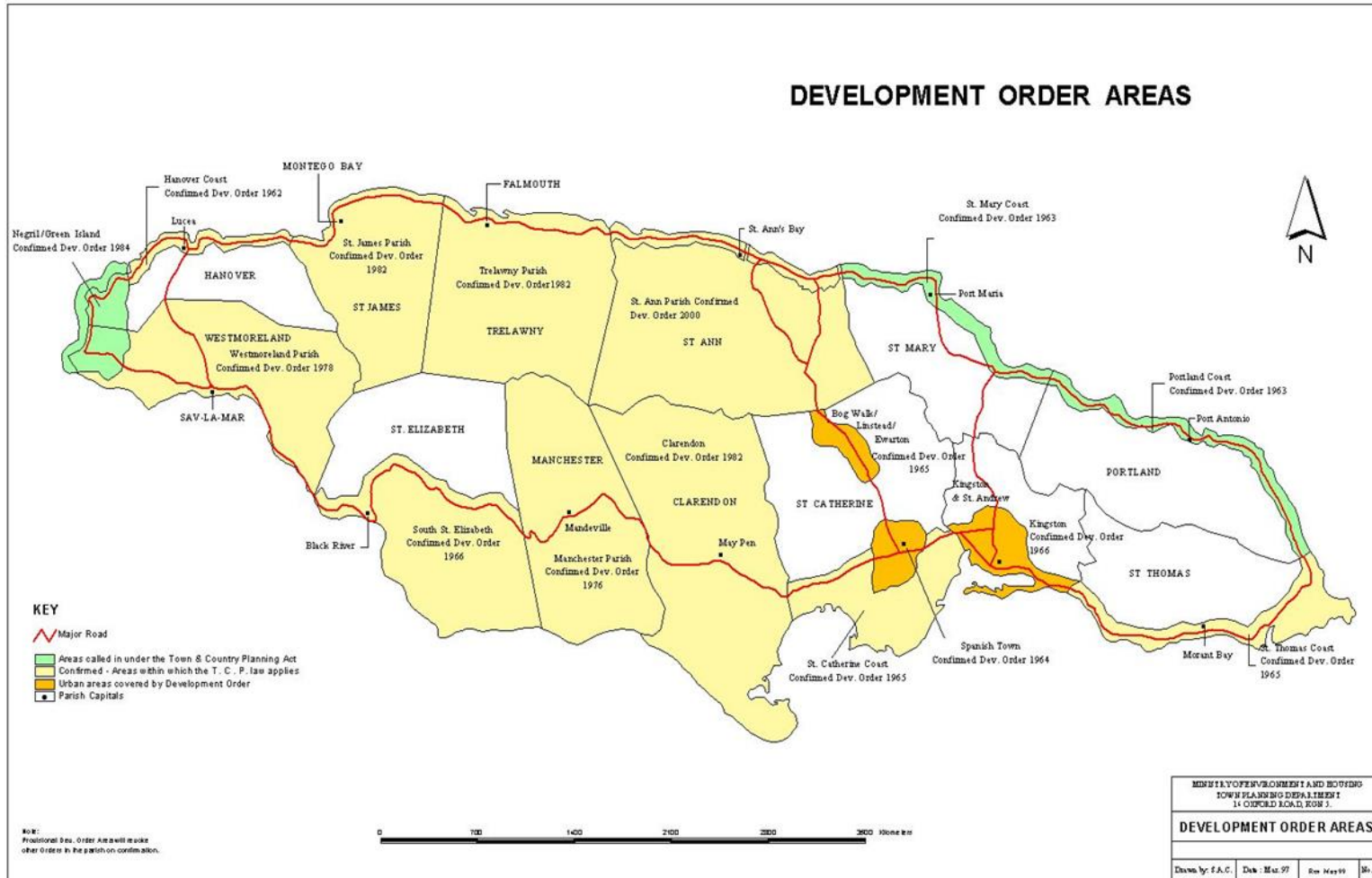

Source: National Environment and Planning Agency<sup>2</sup>

Figure 2-1 Development Order Areas in Jamaica

<sup>2</sup> [http://www.nepa.gov.jm/symposia\\_03/Laws/Maps/Map\\_of\\_Development\\_Orders.htm](http://www.nepa.gov.jm/symposia_03/Laws/Maps/Map_of_Development_Orders.htm)

### 2.2.1.3 *Public Cemetery Management and Regulation Act 1894 (Amended 1995)*

This Act speaks to the applicable lands, burial rights, management, rights, regulations and restrictions pertaining to public cemeteries in Jamaica. As stipulated in this Act, Parish Councils:

- Shall enclose the cemetery by a suitable wall, railing or other fence, and shall make all necessary and proper sewers and drains in and about the cemetery for draining and keeping the same dry and may from time to time, as occasion requires, alter any such sewer or drain, or open out any existing sewer;
- May provide fit and proper places in which bodies may be received and taken care of prior to interment, and make arrangements for the reception and care of the bodies to be deposited therein;
- May lay out and embellish the ground of the cemetery in such manner as it thinks fit; (d) may build on any portion of the cemetery, not especially set apart as herein provided, a dwelling-house and offices for the keeper thereof; and
- Shall keep the cemetery and buildings and fences thereof in proper repair and in good order and condition.

### 2.2.1.4 *The Kingston and St. Andrew Cemeteries Act*

The Kingston and St. Andrew Cemeteries Act, though applicable to the Kingston and St. Andrew area, was used a guideline to inform the St. Catherine Parish Council of regulations and rights pertaining to cemeteries in St. Catherine. Accordingly, the St. Catherine Parish Council has adopted the following rights<sup>3</sup>:

- 1) May appoint a keeper of the cemetery and other officers and servants necessary for the care and use of the cemetery, and may pay them salaries, wages and allowances as they may think fit, out of the moneys to be received under this Part and may remove them or any of them at pleasure.
- 2) Has the power to sell rights of burial and rights to build vaults, monuments, tablets, etc.
- 3) Has the power to fix and receive, and revise fees for burial and special rights in respect of interments in the cemetery as they shall think fit, and also the sums to be paid for the exclusive right of burial either in perpetuity or for a limited period in the cemetery.
- 4) Has the power of constructing any vault or place with the exclusive right of burial therein in perpetuity, or for a limited period, and also the right of erecting or placing any monument, grave stone, tablet or monumental inscription in the said cemetery.
- 5) May from time to time revise or alter such fees, payments or sums, as aforesaid; and:
  - A table of such fees, payments and sums and all other fees and payments in respect of interments in the cemetery;
  - Together with the name or names of the person or persons authorized to receive the same on behalf of the Council;

<sup>3</sup> [http://www.stcatherinepc.gov.jm/index.php?option=com\\_content&task=view&id=46&Itemid=61](http://www.stcatherinepc.gov.jm/index.php?option=com_content&task=view&id=46&Itemid=61)

- Shall be printed and at all times kept conspicuously exhibited at or near the gate of the cemetery;
- Providing that all such fees, payments and sums shall be so fixed as aforesaid, subject to the approval of the Minister;
- And no such fees, payments and sums shall be altered or varied without such (the Minister's) approval.

#### **2.2.1.5 Land Acquisition Act (1947)**

The Land Acquisition Act was passed in 1947. As stipulated under Section 3 of this Act, any officer authorized by the Minister may enter and survey land in any locality that may be needed for any public purpose. This may also involve:

- Digging or boring into the sub-soil;
- Cutting down and clearing away any standing crop, fence, bush or woodland;
- Carrying out other acts necessary to ascertain that the land is suitable for the required purpose.

The Minister is authorized to make a public declaration under his signature if land is required for a public purpose, provided that the compensation to be awarded for the land is to be paid out of the Consolidated Fund or loan funds of the Government and funds of any Parish Council, the Kingston and St. Andrew Corporation or the National Water Commission.

Once the Commissioner enters into possession of any land under the provisions of this Act, the land is vested in the Commissioner of Lands and is held in trust for the Government of Jamaica in keeping with the details stated in Section 16. The Commissioner shall provide the Registrar of Titles with a copy of every notice published, as well as a plan of the land. The Commissioner will also make an application to the Registrar of Titles in order to bring the title of the land under the operation of the Registration of Titles Act.

#### **2.2.1.6 The Jamaica National Heritage Trust Act 1985**

The Jamaica National Heritage Trust Act has been in operation since 1985 with the main goal of preserving and protecting the country's national heritage. This Act established the Jamaica National Heritage Trust (JNHT) whose functions are outlined in Section 4 of the Act as follows:

- a) To promote the preservation of national monuments and anything designated as protected national heritage for the benefit of the Island;
- b) To conduct such research as it thinks necessary or desirable for the purposes of the performance of its functions under this Act;
- c) To carry out such development as it considers necessary for the preservation of any national monument or anything designated as protected national heritage;



- d) To record any precious objects or works of art to be preserved and to identify and record any species of botanical or animal life to be protected.

The Act also states the following offences are liable to a fine and/or imprisonment:

- Wilfully defacing, damaging or destroying any national monument or protected national heritage;
- Wilfully defacing, destroying, concealing or removing any mark affixed or connected to a national monument or protected national heritage;
- Altering any national monument or marking without the written permission of the Trust;
- Removing any national monument or protected national heritage to a place outside of Jamaica.

## 2.2.2 Environmental Conservation

### 2.2.2.1 *Natural Resources Conservation Act 1991*

The Natural Resources Conservation Act (NRCA) may be considered Jamaica's umbrella environmental law. The purpose of the Act is to provide for the management, conservation and protection of the natural resources of Jamaica. This Act was passed in the Jamaican Parliament in 1991 and subsequent to this; the Natural Resources Conservation Authority (NRCA) was established with the function of taking necessary steps to ensure the sustainable development of Jamaica through the protection and management of Jamaica's physical environment. The NRCA Act, under Sections 9 and 10 specifies that an Environmental Impact Assessment (EIA) is required from an applicant for a permit for undertaking any new construction, enterprise or development. It also speaks to the designation of national parks, protected areas etc.

The Act also gave power of enforcement of a number of environmental laws to the NRCA, namely the *Beach Control Act*, *Watershed Act* and the *Wild Life Protection Act*, as well as a number of regulations and orders including

- *The Natural Resources (Permit and Licences) Regulations (1996)*
- *The Natural Resources (Marine Park) Regulations 1992, The Natural Resources (Marine Park) (Amendment) Regulations 2003*
- *The Natural Resources (Prescribed Areas) (Prohibition of Categories of Enterprise, Construction and Development) Order 1996*

Under the Act, the NRCA/NEPA has a number of powers relevant to the proposed project including the issuing, revocation and suspension of permits to persons responsible for undertaking any construction, enterprise or development of a prescribed category in a prescribed area, including power generation facilities. Further, requesting an Environmental Impact Assessment (EIA) from an applicant for a permit or the person responsible for undertaking any construction, enterprise or development,



as was done with this proposed project. Additional details were described previously in section 2.1 (EIA Framework).

#### **2.2.2.2 *The Natural Resources (Permit and Licences) Regulations (1996)***

A permit and licencing system was established under these regulations in order to control the undertaking of any new construction or development of a prescribed nature in Jamaica and the handling of sewage or trade effluent and poisonous or harmful substances discharged into the environment. It is administered by the Natural Resources Conservation Authority (NRCA)/National Environment and Planning Agency (NEPA)

#### **2.2.2.3 *The Natural Resources (Prescribed Areas) (Prohibition of Categories of Enterprise, Construction and Development) Order 1996***

Section 9 of the NRCA Act declare the entire island and the territorial sea as 'prescribed area', in which specified activities require a permit, and for which activities an environmental impact assessment may be required. The Natural Resources (Prescribed Areas) (Prohibition of Categories of Enterprise, Construction and Development) Order (1996) and the Permits & Licensing Regulations was passed as a result of section 9 of the NRCA Act. As discussed previously, an EIA was required for the proposed project and this report fulfils one component of the EIA process.

#### **2.2.2.4 *Wild Life Protection Act 1945***

The Wild Life Protection Act of 1945 is mainly concerned with the protection of specified faunal species and is the only statute in Jamaica specifically designated to this. This Act protects several rare and endangered faunal species including six species of sea turtle, one land mammal, one butterfly, three reptiles and a number of game birds. A list of these protected species is provided in this Act under the Second and Third Schedules and is presented in Figure 2-2. The establishment of two types of protected areas, namely Game Sanctuaries and Game Reserves is authorized under this Act. It is administered by Natural Resources Conservation Authority (NRCA)/National Environment and Planning Agency (NEPA) and designated personnel include Game Wardens, Constables and Fishery Inspectors.

Offenses cited under this Act and relevant to project and particularly during construction phases should be borne in mind. These include hunting protected animal or bird and the possession of all or part of protected animal or bird.

### Protected Jamaican Animals

<u>Common Names</u>	<u>Scientific Names</u>
 Sperm Whale	<i>Physeter macrocephalus</i>
Baird's beaked Whale	<i>Berardius bairdii</i>
Short-finned pilot Whale	<i>Globicephala macrorhynchus</i>
Humpback Whale	<i>Megaptera novaeangliae</i>
Common Bottlenose Dolphin	<i>Tursiops truncatus</i>
Pantropical spotted Dolphin	<i>Stenella attenuata</i>
West Indian Manatee	<i>Trichechus manatus manatus</i>
Caribbean Monk Seal (Pedro Seal)	<i>Monachus tropicalis</i>
Jamaican Hutia (Coney)	<i>Geocapromys brownii</i>
American Crocodile	<i>Crocodylus acutus</i>
Jamaican Iguana	<i>Cyclura collei</i>
Yellow Snake/Jamaican Boa	<i>Epicrates subflavus</i>
Green Turtle	<i>Chelonia mydas</i>
Hawksbill Turtle	<i>Eretmochelys imbricata</i>
Loggerhead Turtle	<i>Caretta caretta</i>
Atlantic Kemps Ridley	<i>Lepidochelys kempii</i>
Leatherback turtle	<i>Dermochelys coriacea</i>
Reid Seahorse	<i>Hippocampus reidii</i>
Jamaican Kite Swallowtail	<i>Eurytides marcellinus</i>
Giant Swallowtail Butterfly	<i>Papilio homerus</i>
Black Coral	<i>Antipathes species</i>
White Coral	<b>Scleractinian or Madreporarian</b>
 <b>All birds are protected except the following:</b>	
Cattle Egret	<i>Bubulcus ibis</i>
Rock Dove (Pigeon)	<i>Columba livia</i>
Ringed-turtle Dove (Barble Dove)	<i>Streptopelia risoria</i>
European Starling	<i>Sturnus vulgaris</i>

### Protected Jamaican Animals Cont'd

All birds are protected except the following:

Saffron Finch (Wild Canary)

*Scalis flaveola*

House Sparrow

*Passer domesticus*

Yellow-crowned Bishop

*Euplectes afer*

Red Bishop

*Euplectes orix*

Nutmeg Mannikin

*Lonchura punctulata*

Chestnut Mannikin

*Lonchura Malacca*

Shiny Cowbird

*Molothrus bonariensis*

Chickens

*Gallus gallus*

Geese

*Anser spp.*

Turkey

*Meleagris gallopavo*

Guinea fowl

*Nunida meleargris*

Pea fowl

*Pavo cristatus*

Budgerigars

*Melopsittacus undulates*

Cockatiel

*Nymphicus hollandicus*

Ducks excluding endemic and migratory species

**GAME BIRDS (These are protected outside of the bird shooting season)**

Mourning Dove (Long-tailed Pea Dove)

*Zenaida macroura*

White-winged Dove

*Zenaida asiatica*

White-crowned Pigeon (Bald pate)

*Columba leucocephala*

Blue-winged Teal

*Anas discors*

Green-winged Teal

*Anas crecca*

Prepared by the Biodiversity Branch, National Environment and Planning Agency  
Updated March, 2005

Source: National Environment and Planning Agency (NEPA) <sup>4</sup>

Figure 2-2 Protected animals in Jamaica

<sup>4</sup> <http://www.nepa.gov.jm/publications/brochures/flyers/protected%20Jamaican%20animals.pdf>

#### **2.2.2.5 The Endangered Species Act 2000**

The Endangered Species (Protection, Conservation and Regulation of Trade) Act was created in 2000 in order to ensure the codification of Jamaica's obligations under the Convention for the International Trade in Endangered Species of Wild Fauna and Flora. This Act governs international and domestic trade in endangered species in and from Jamaica. Under this act, the functions of NEPA include the grant of permits and certificates for the purpose of international trade, the determination of national quotas and the monitoring of the trade in endangered species. Sea turtles, in addition, to yellow snakes and parrots are often traded illegal internationally and are endangered. It is administered by the Natural Resources Conservation Authority (NRCA)/National Environment and Planning Agency (NEPA). Designated personnel include person designated by NRCA; Customs Officer; Game Warden; member of JCF or JDF; Fishery Inspector; Marine Officer; Inspector; Forest Officer; National and Marine Park Ranger. Offenses cited under this Act, including the trade in any endangered species without a certificate or permit should be borne in mind throughout the project duration.

#### **2.2.2.6 Water Resources Act 1995**

The Water Resources Act (1995) was promulgated in the Jamaican Parliament in September 1995 and ratified in April 1996. It ensures the proper administration, development and optimal use of Jamaica's water resources. This Act established the Water Resources Authority (WRA), which is authorized to regulate, allocate, conserve and manage the water resources of the island. The WRA is also responsible for water quality control; as stipulated under Section 4 of the Act the WRA is responsible for providing any department or agency of Government, technical assistance for any projects, programmes or activities relating to development, conservation and the use of water resources.

Section 25 advises that a proposed user will have to obtain planning permission, if this is a requirement, under the Town and Country Planning Act. In addition, under Section 21 it states that if the water to be used will result in the discharge of effluents, an application for a license to discharge effluents will have to be made to the Natural Resources Conservation Authority or any other relevant body as indicated by the Minister.

#### **2.2.2.7 The Forest Act 1996**

The 1996 Forest Act repealed the 1937 legislation and was the legal basis for the organization and functioning of the Forestry Department. The Forestry Department is an independent entity established in 1942, subsequent to the Forest Division of the Department of Agriculture (1938) and the Forest Branch of the Lands Department (1937). The Forestry Department is the lead agency responsible for the management and conservation of the forest resources in Jamaica. The management of forests on a sustainable basis in an aim to maintain and increase the environmental services and economic benefits is the Forestry Department's main function. There are also a set of *Forest Regulations (2001)* which are administered by the Forestry Department as well.

A "Forest Reserve" is defined to be any area of land declared by or under this Act to be a forest reserve. In 1938, the Forest Branch gazetted some 78,800 hectares of Crown Lands as forest reserves, this making up more than 75% of the present day forest reserves. Following this, these reserve areas were added to by purchase, lease and other arrangements. Please see Figure 2-3 for the location of forest estates across the island. Though the proposed project does not fall within a forest reserve, mention should still be made as it relates to any project operations associated with the project that may be in proximity of any forest estates (see Figure 2-3). In addition, the following are some offences under this act:

- Cut a tree in forest reserve without valid permit
- Fell, cut, girdle, mark, lop, tap, uproot, burn, damage, debark, strip/remove leaves of a tree
- Kindle, keep, carry lit material
- Clear or break up land
- Establish or carry on forest industry
- Remove soil, gravel or sand
- Unlawfully/illegally affix forest officer mark to any tree/timber
- Alter, deface/obliterate mark placed by forest officer on tree/timber
- Pasture/allow cattle trespass

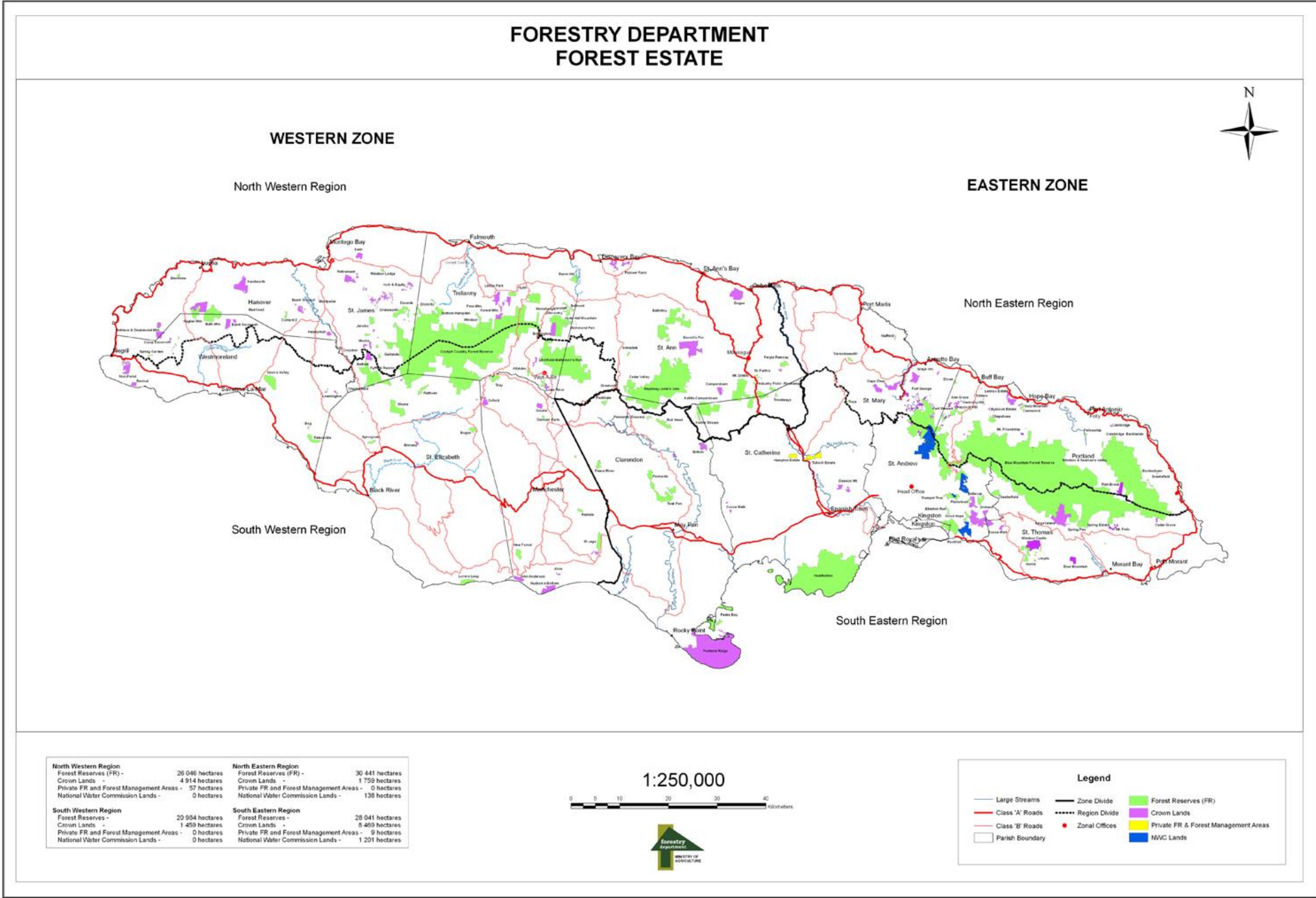

Source: Forestry Department <sup>5</sup>

Figure 2-3 Map showing forest estates across the island, including reserves, crowned lands, private areas and NWC lands

<sup>5</sup> [http://www.forestry.gov.jm/images/res250k\\_bg.jpg](http://www.forestry.gov.jm/images/res250k_bg.jpg)



#### **2.2.2.8 Policy for the National System of Protected Areas 1997**

According to the NEPA, a protected area is “an area of land or water that is managed for the protection and maintenance of its ecological systems, biodiversity and/or specific natural, cultural or aesthetic resources.” As stated in the green paper, the system of protected areas should be an essential tool for environmental protection, conserving essential resources for sustainable use, helping to expand and diversify economic development, and contributing to public recreation and education. Though the proposed study does not fall within an area protected under any legal instrument or agreement; it is crucial to note existence of these areas.

Natural Resources Conservation Authority (NRCA)/ National Environment and Planning Agency (NEPA) has responsibility under the Wild Life Protection Act, the Watersheds Protection Act and the Beach Control Act for certain protected areas, including game sanctuaries and game reserves. Management authority for other areas is conferred on the responsible agency by its establishing legislation, such as the Fishing Industry Act (1975), the Forest Act (1937), and the Jamaica National Heritage Trust Act (1985). In addition, environmental non-government organisations play a key role in the management of protected areas across Jamaica.

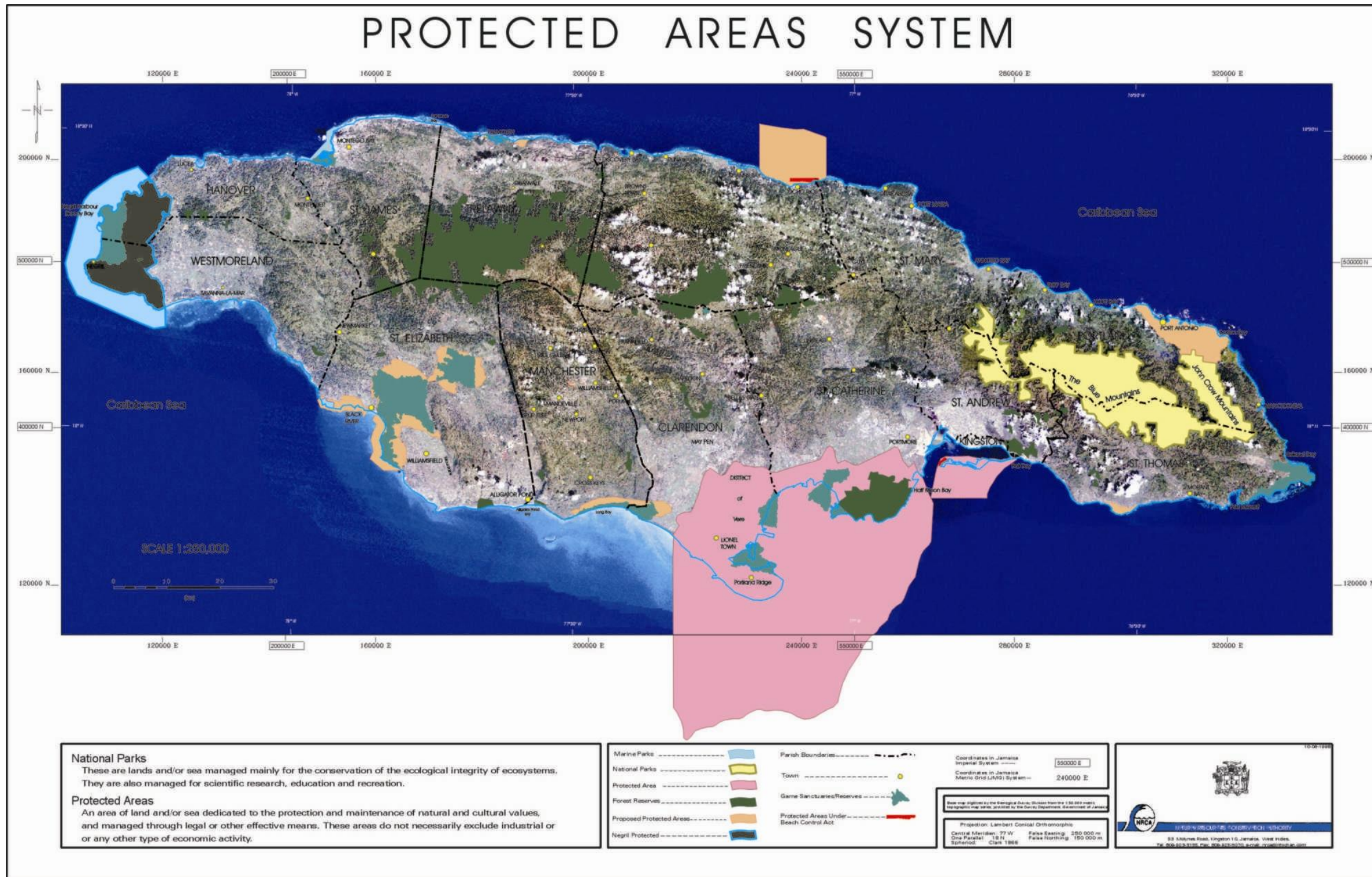

Source: National Environment and Planning Agency

Figure 2-4 Protected Areas system in Jamaica

## 2.2.3 Public Health & Waste Management

### 2.2.3.1 Water Quality Standards

The NRCA has primary responsibility for control of water pollution in Jamaica. National Standards for industrial and sewage discharge into rivers and streams, in addition to standards for ambient freshwater exist. For drinking water, World Health Organization (WHO) Standards are utilized and these are regulated by the National Water Commission (NWC).

Table 2-1 Draft national ambient marine water quality standards for Jamaica, 2009

Source: National Environment and Planning Agency (NEPA)

Parameter	Measured as	Standard Range	Unit
Phosphate,	P*	0.001-0.003	mg/L
Nitrate,	N**	0.007-0.014	mg/L
BOD <sub>5</sub>	O	0.0-1.16	mg/L
pH		8.00-8.40	
Total Coliform		2-256	MPN/100mL
Faecal Coliform		<2-13	MPN/100mL

\*Reactive phosphorus as P

\*\*Nitrates as Nitrogen

Water quality is a crucial aspect of the proposed project and efforts must be made to ensure water quality is not adversely affected. Water quality assessment is a main part of the environmental description for the project and various parameters were assessed prior to project implementation for the purposes of this EIA.

### 2.2.3.2 The National Solid Waste Management Authority Act 2001

The National Solid Waste Management Authority Act of 2001 is “an act to provide for the regulation and management of solid waste; to establish a body to be called the National Solid Waste Management Authority and for matters connected therewith or incidental thereto”. The National Solid Waste Management Authority (NSWMA) was established in April 2002 as a result of this Act to effectively manage and regulate the collection and disposal of solid waste in Jamaica. As such, the NSWMA aims to safeguard public health and the environment by ensuring that domestic waste is collected, sorted, transported, recycled, reused or disposed of in an environmentally sound manner. In addition, public awareness and education is a part of their responsibilities.

### 2.2.3.3 Public Health Act 1985

The Public Health Act is administered by the Ministry of Health through Local Boards, namely the parish councils. *The Public Health (Nuisance) Regulations 1995* aims to control, reduce or prevent air, soil and water pollution in all forms. Under the regulations:



- No individual or organization is allowed to emit, deposit, issue or discharge into the environment from any source;
- Whoever is responsible for the accidental presence in the environment of any contaminant must advise the Environmental Control Division of the Ministry of Health and Environmental Control, without delay;
- Any person or organization that conducts activities which release air contaminants such as dust and other particulates is required to institute measures to reduce or eliminate the presence of such contaminants; and
- No industrial waste should be discharged into any water body, which will result in the deterioration of the quality of the water.

Offences listed above must be adhered to during the project cycle.

#### **2.2.3.4 *The Natural Resources (Hazardous Waste) (Control of Transboundary Movement) Regulations 2003***

These regulations control transboundary movement and prevent the illegal trafficking of certain hazardous wastes. These regulations seek to implement the *Basel Convention on the Transboundary Movement of Hazardous Waste*. It is an offence to unlawfully dump or otherwise dispose of hazardous waste in area under jurisdiction of Jamaica. Further, it is an offence to import, transit through, or export hazardous waste into or from an area under Jamaica's jurisdiction:

- a) Without notification to every State involved,
- b) Without a permit and the consent of every State involved.
- c) With consent obtained from a State concerned through falsification, misrepresentation or fraud.
- d) That does not conform with the documents.
- e) That results in the unlawful disposal of hazardous wastes in contravention of the Convention, Act, or these Regulations.

"Area under Jamaica's jurisdiction" includes any land, marine area or air space within which Jamaica exercises administrative or regulatory responsibility; internal waters and the Exclusive Economic Zone; and any ship or aircraft registered in Jamaica. Waste resulting from the proposed project should be properly disposed of, and special attention should be paid to those considered hazardous under these regulations and as listed above.

#### **2.2.3.5 *Noise Abatement Act 1997***

The Noise Abatement Act of 1997 was created in order to regulate noise caused by amplified sound and other specified equipment. This act has been said to address "some concerns but is too narrow in scope and relies on a subjective criterion" (McTavish). Given this, McTavish conducted a study to recommend wider and more objective criteria in accordance with international trends and standards, but tailored to Jamaica's conditions and culture. To date, apart from the Noise Abatement Act (1997), Jamaica has no other national legislation for noise.

### **2.2.3.6 Country Fires Act 1942**

Under the Country Fires Act of 1942, the setting of fire to trash without prior notice being given to the nearest police station and the occupiers of all adjoining lands is prohibited. In addition, a space of at least fifteen feet in width must be cleared around all trash to be burnt and all inflammable material removed from the area. Section 6 of the Act empowers the Minister to prohibit, as may be necessary, the setting of fire to trash without a permit. Offences include:

### **2.2.3.7 The Pesticides (Amendment) Act 1996**

The Pesticides (Amendment) Act of 1996 amended sections of the principal act, which came into effect in 1975 and established the Pesticides Control Authority. This Act gives the Authority the responsibility of controlling the importation, manufacture, packaging, sale, use and disposal of pesticides. Under Section 16 of the Act, the Authority may, with the approval of the Minister, make regulations which relate to areas such as the aerial application of pesticides; permissible levels of pesticides to be used; and the disposal of pesticides and packages.

## **2.3 REGIONAL AND INTERNATIONAL LEGISLATIVE AND REGULATORY CONSIDERATIONS**

### **2.3.1 United Nations Convention on Biological Diversity**

Signed by 150 government leaders at the 1992 Rio Earth Summit, the Convention on Biological Diversity (CBD) is committed to promoting sustainable development. The CBD is regarded as a means of translating the principles of Agenda 21 into reality and recognizes that “biological diversity is about more than plants, animals and microorganisms and their ecosystems – it is about people and our need for food security, medicines, fresh air and water, shelter, and a clean and healthy environment in which to live”.

The CBD may be considered the first global, comprehensive agreement which focuses on all aspects of biodiversity, to include genetic resources, species and ecosystems. In order to achieve its main goal of sustainable development, signatories are required to:

- Develop plans for protecting habitat and species.
- Provide funds and technology to help developing countries provide protection.
- Ensure commercial access to biological resources for development.
- Share revenues fairly among source countries and developers.
- Establish safe regulations and liability for risks associated with biotechnology development.

Jamaica’s Green Paper Number 3/01, ‘Towards a National Strategy and Action Plan on Biological Diversity in Jamaica’, is evidence of Jamaica’s continuing commitment to its obligations as a signatory to the Convention.

### **2.3.2 Convention on International Trade in Endangered Species of Wild Flora and Fauna (CITES)**

CITES generally seeks to protect endangered plants and animals and owing to the cross boundary nature of animals and plants, this protection requires international cooperation. It aims to ensure that international trade of wild animal and plant species does not threaten the survival of the species in the wild, and it accords varying degrees of protection to over 35,000 species. This convention was drafted in 1963 at a meeting of members of the International Union for Conservation of Nature (IUCN) and finalised in 1973. After being opened for signatures in 1973, CITES entered into force on 1 July 1975.

## 3.0 COMPREHENSIVE DESCRIPTION OF THE PROPOSED PROJECT

### 3.1 THE PROPONENT

Kumanda Park Limited has been registered company in Jamaica since 1991. Its registered office is located at 11 ½ - 13 Lindsay Crescent, Kingston 10. It has the responsibility of overseeing the management of the Dovecot properties for Madden's. Madden's have branches in Lucea, Montego Bay, Constant Spring Road, the casket production company, situated at Norman Road and Head Office on North Street.

The complete funeral service is offered by Madden's. This includes choosing the type of funeral service and the location. The following are also included:

- Wide selection of Caskets to suit the family's budget and one which suits the personality of the deceased and respects his or her family wishes.
- Selection of hearse, provision of hearse traditional and non-traditional.
- Embalming and restorative art
- Cemetery facility
- Cremation and Urn Selection
- Placement of death announcements in the daily newspaper and on radio
- Book of floral arrangements
- Transportation for the Family
- Booking musicians and /or vocalists
- Design and print programmes
- Prepaid arrangements
- Exhumation
- Burials, Urn Burials
- Chapel facilities
- Stress Management

At the request of the bereaved families, they book and provide stationery as keepsakes in memory of the deceased. Some of these items include:

- Book markers
- Prayer cards
- Thank you cards
- Tee Shirts

## 3.2 HISTORY AND PROJECT BACKGROUND

When Leslie Ferdinand Madden built his first coffin under a huge guinep tree on North Street in Kingston, little did he know that the name Madden's would stand out as a beacon and as the leader in professional final care services. That large guinep tree has long since been replaced by a modern office building and chapel. The stately horse drawn hearses which were the order of the day in the 1930s, are now substituted with impressive new Cadillac's and stylish carriages to be on par with the changing and discerning tastes of clients.

Leslie Madden was known as the master of the profession in the 1930s when herbs, spices and coolers were used to preserve and prepare bodies for burial. This earned him the respect of the community as the finest in the business of final care services. Added to that, he made sure that no matter the financial status of the deceased, they were accorded a dignified burial, even if he was paid in instalments. Today, the legacy lives on, and the third and fourth generation Madden clan continue to operate the business in the same vein.

Dovecot was originally owned by Victor Morris which features 53 acres (21.4 ha) of extensive lawns with flat headstones, based on a concept developed in the United States. He operated Dovecot for 2 ½ years before deciding to migrate and sell the property in 1977. It was at this time that an agreement was reached with Madden's for the sale of the property located at St. John's Road, near Spanish Town, St. Catherine. Dovecot (St. Catherine) accommodates an average of 1,500 burials annually for the past 12 years.

With the Pye River Cemetery in Montego Bay rapidly running out of space, Dovecot St. James was created and opened in 2004 and has accommodated an average 400 burials per year. The proposed expansion of the Dovecot Memorial Garden (St. Catherine) will allow for burials to occur for an approximate 48 years based on current average rate of burials.

## 3.3 PROJECT LOCATION

The proposed development is located in Chisholm Bendon Pen, St. Catherine, Jamaica. It is situated about 80 meters above sea level, approximately 500 metres west of the current Dovecot Memorial Park, a kilometre north of Bellevue Heights, about 6.5 kilometres west from Spanish Town along St. Johns Road and contiguous to Naseberry Grove to the south (Figure 3-1).



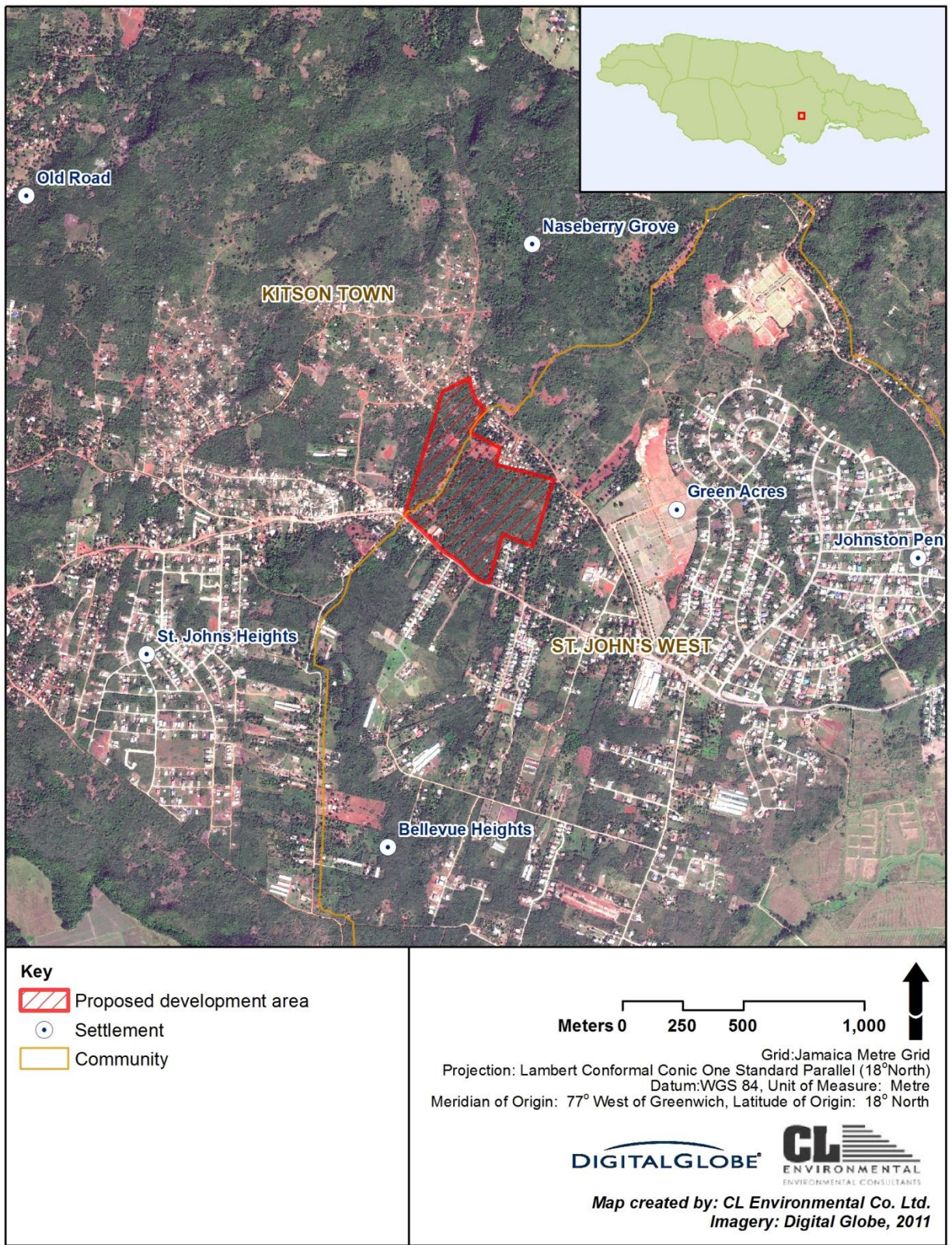

Figure 3-1 Location of proposed expansion site

### 3.4 PROJECT COMPONENTS AND DESIGN

#### 3.4.1 Description

The proposed project is an expansion of operation for the Dovecot Memorial Park on St. Johns Road in St. Catharine. It is intended that the 71 acre (28.7 hectares, 0.29 km<sup>2</sup>) property is to be developed to accommodate 48,120 burial vaults (≈ 15.7 ha) and sanitary facilities (225 m<sup>2</sup>). The existing Bendon Seventh Day Adventist church will remain and 17,520 m<sup>2</sup> of internal road ways will be put in place as the main artery of the property.

The proposed Dovecot expansion (28.7 ha) will be larger than the existing cemetery which has an area of approximately 21.4 ha.

##### 3.4.1.1 Vaults

As stated above the expected number of vaults to be created as a result of this expansion is 48,120 of which 50% will be single vaults and the other 50% will be double vaults. With a land area of 28.7 ha, the burial density is 1,676.65 vaults per hectare.

The typical vault layout will be 2.34 m long, 0.84 m wide and 1.52 m deep (92" x 33" x 60"). The schematic layout of a typical vault is depicted in Figure 3-2 and Figure 3-3.

The walls of the vaults will be constructed of concrete blocks, steel and poured concrete, the bottom of compact marl and stone and the top, a slab 3" thick made of cage of 1/2" steel and poured concrete. Each vault will be sealed with concrete on completion of a burial.

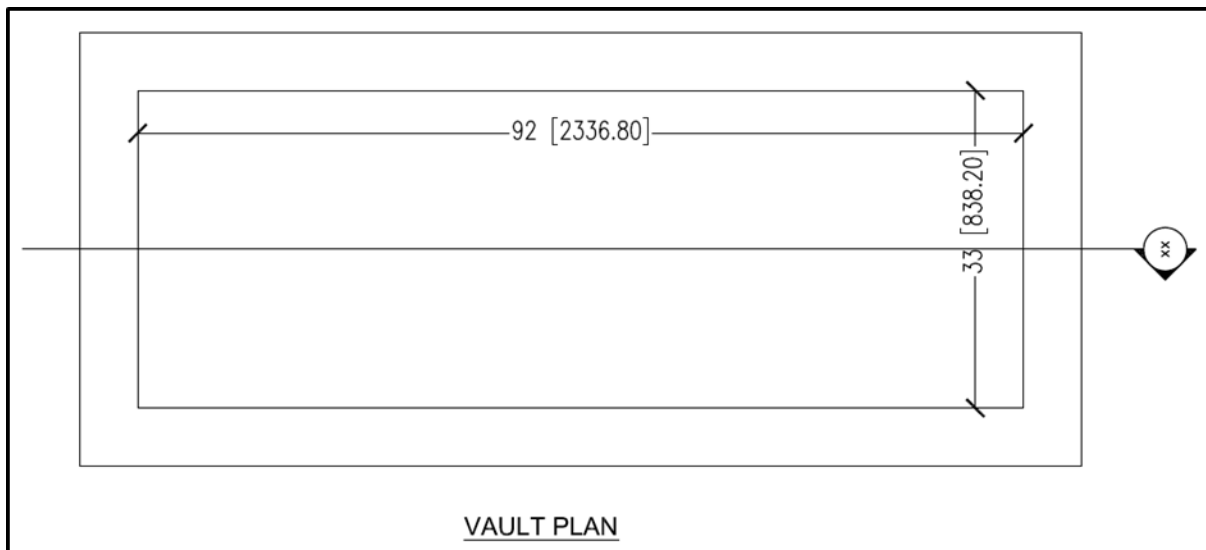

Figure 3-2 Schematic of a typical vault plan

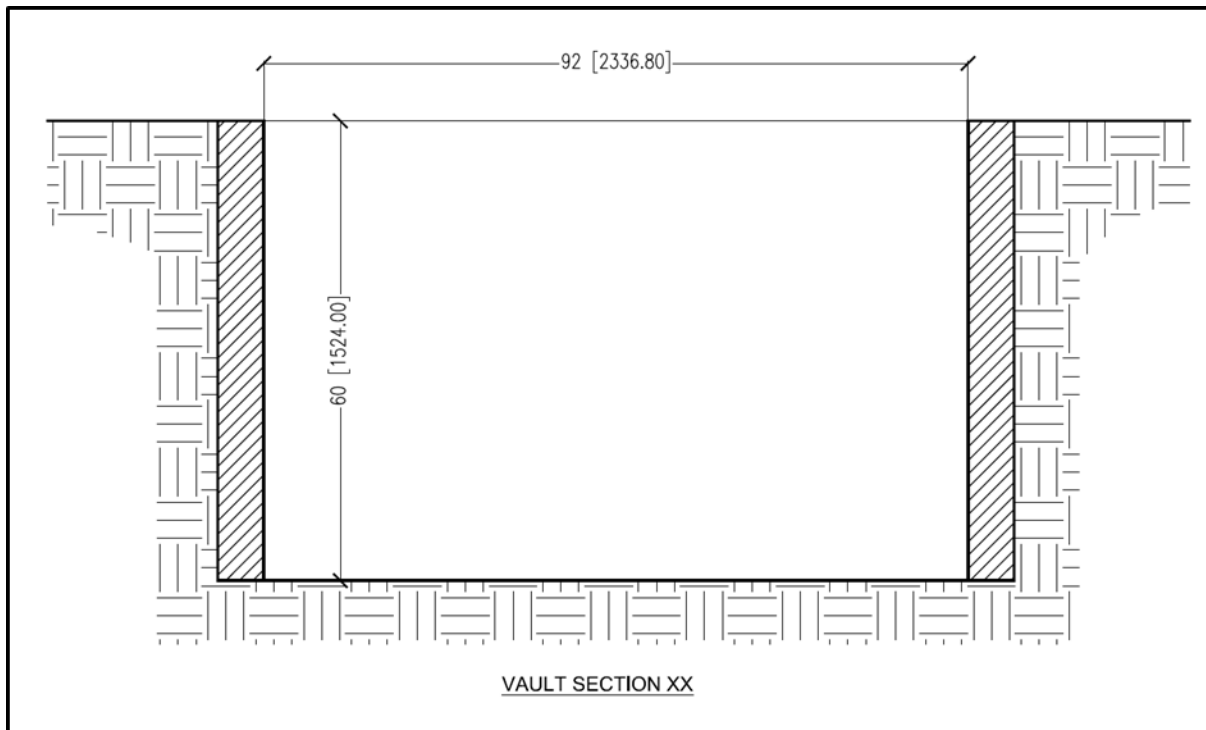

Figure 3-3 Schematic of a typical vault section

### 3.4.2 Water Supply and Sewage Disposal

The National Water Commission (NWC) supplies the existing site with potable water and sewage is presently managed with septic tanks and an absorption pit.

The proposed sewage treatment for the new expansion is by septic tank and evapotranspiration bed. Sewage will be collected from the three (3) restroom areas with initial treatment provided by septic tanks at each set of restrooms. The effluent from the two higher (in elevation) restrooms septic tanks will be conveyed by pipes down to the lowest restroom where it will connect into the outlet pipe from the septic tank there. The total effluent flow from the three (3) septic tanks will then enter the adjacent evaporation bed via a distribution box for final treatment and disposal. The effluent from the septic tank system will pass through a distribution network in a specially prepared mass of suitable sand and gravel layers. The effect of capillary action and shallow rooting perennial plants will result in the loss of effluent by evapotranspiration. The bed allows for storage of excess effluent during periods of low evapotranspiration, acting like a sponge, while the convex surface encourages the shedding of a proportion of the rainfall. The bed is lined at the bottom and sides with a synthetic liner which prevents any seepage of effluent into the soil below. A 15m x 15m (225 m<sup>2</sup>) evapotranspiration bed will be used.

It is anticipated that water demand will come from two main sources; these are the bathrooms/showers and the irrigation areas. The estimated water demand is based on a per capita



usage by staff (30) and an estimated 1000 visitors per day as well as the irrigation requirements per acre for grass (California State Water Resources Control board, 1984). The total required volume of water required per day is estimated at 1,334m<sup>3</sup>/d (≈352,405 us gal/day) on average when the full 12 phases are realized. Table 3-1 outlines the daily cumulative demands for phases 1, 3, 6, 9 and 12.

Table 3-1 Water Demand per day for workers and for Irrigation shown across 5 of the 12 phases of the development

Water Use	Phase 1	Phase 3	Phase 6	Phase 9	Phase 12	Units
<b>Irrigation</b>						
Irrigation requirements	16.9	16.9	16.9	16.9	16.9	mm/acre/day
Irrigation Area	1.8	5.1	9.3	14.5	19.3	acres
Daily volume	120.5	347.2	626.5	984.6	1309.1	m <sup>3</sup> /day
<b>Workers</b>						
Water Demand	209	209	209	209	209	L/person/day
No. employees	30	30	30	30	30	
	6.27	6.27	6.27	6.27	6.27	m <sup>3</sup> /day
<b>Visitors</b>						
Water Demand	19	19	19	19	19	L/person/day
No. visitors	1000	1000	1000	1000	1000	
	19	19	19	19	19	m <sup>3</sup> /day
<b>Total Demand</b>	<b>145.7</b>	<b>372.4</b>	<b>651.8</b>	<b>1009.8</b>	<b>1334.4</b>	<b>m<sup>3</sup>/day</b>

It is anticipated that the production of wastewater will be primarily domestic, i.e. from the bathrooms. The generation of the wastewater will be primarily from the staff and daily visitors attending funerals in the park. The estimated total wastewater flows to be generated is therefore in the order of 20.9 m<sup>3</sup>/day (5,521 us gal/day).

Table 3-2 Daily Wastewater generation estimate for the development

Wastewater Generation	Value	Units
<b>Workers</b>		
No. of workers	30	
Wastewater generation per worker	190	L/person/day
	5.7	m <sup>3</sup> /day
<b>Visitors</b>		
No. of Visitors	1000	
Wastewater generation per visitor	15.2	L/person/day
	15.2	m <sup>3</sup> /day
<b>Total Wastewater generation Per day</b>	<b>20.9</b>	<b>m<sup>3</sup>/day</b>

The evapotranspiration system recommended for this area is reasonably sized based on the available design data. Detailed drawings specifications in terms of the beds and their lining to prevent leakage, the specific plant types and spacing required for the maximum uptake should all be done prior to final approval by the EHU/NEPA.

### **3.4.3 Restrooms**

The male and female restrooms will be 2.5m wide, 6.2 m long and 3.1m high.

Figure 3-4 shows the layout and locations of restrooms. Figure 3-5 shows the layout of lower restrooms and septic tank and evapotranspiration bed. Figure 3-6 shows a schematic layout of evapotranspiration bed. Figure 3-7 - Figure 3-9 shows various views of the rest rooms.

### **3.4.4 Solid Waste**

Solid waste generation during cemetery operations will mainly be food and beverage refuse from funeral goers who purchase from any local vendors on the property.

Garbage receptacles will be strategically placed around the cemetery grounds and along the access roads. They will be adequately designed and covered to prevent access by vermin and minimise odour. Staff members will be designated to empty contents of the garbage receptacles into a central garbage skip easily accessible by the NSWMA garbage truck. Disposal of the contents of the skip will be done at an approved disposal site (Riverton Landfill).

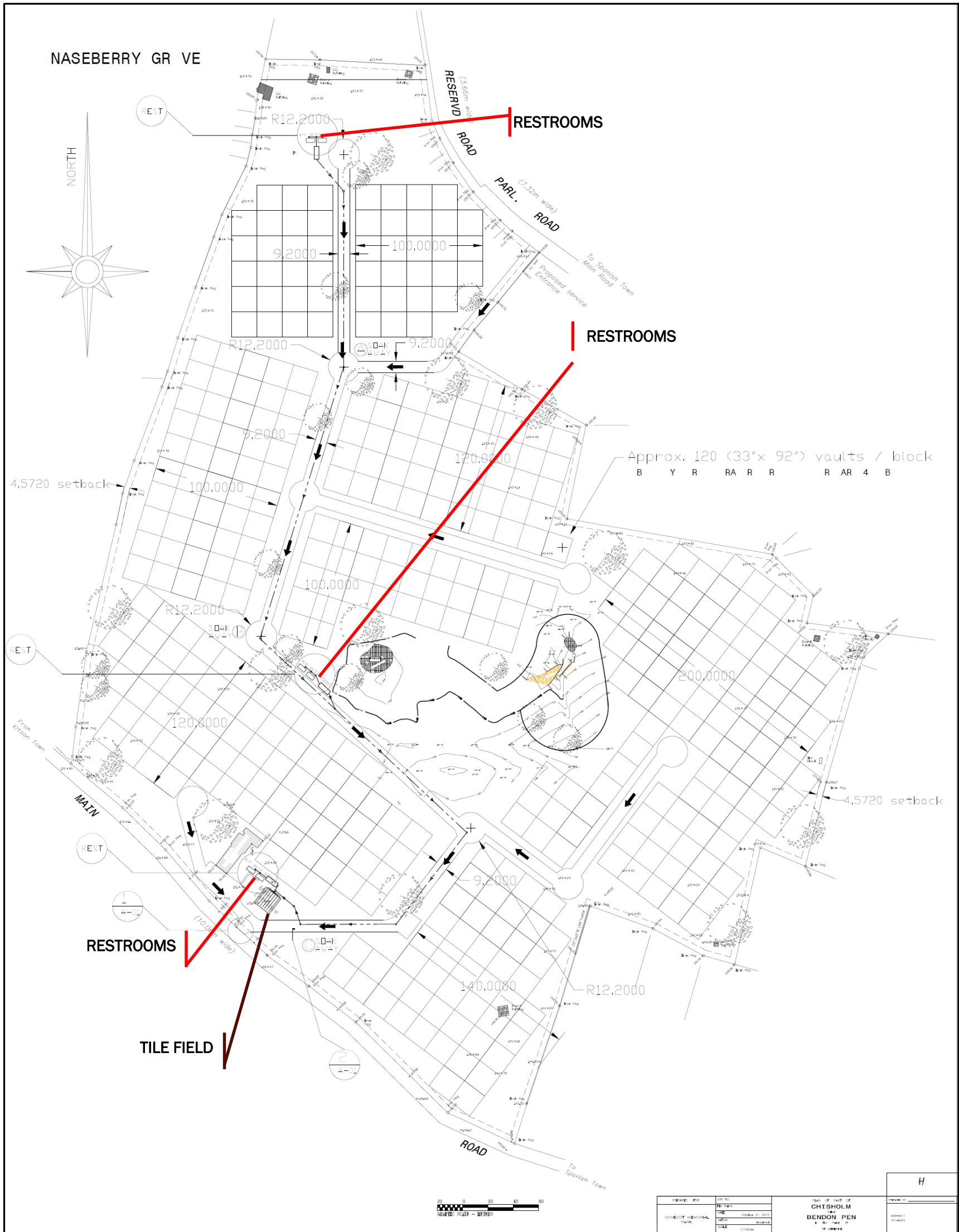

Figure 3-4 Layout of the proposed Dovecot expansion depicting the locations of the restrooms and tile field

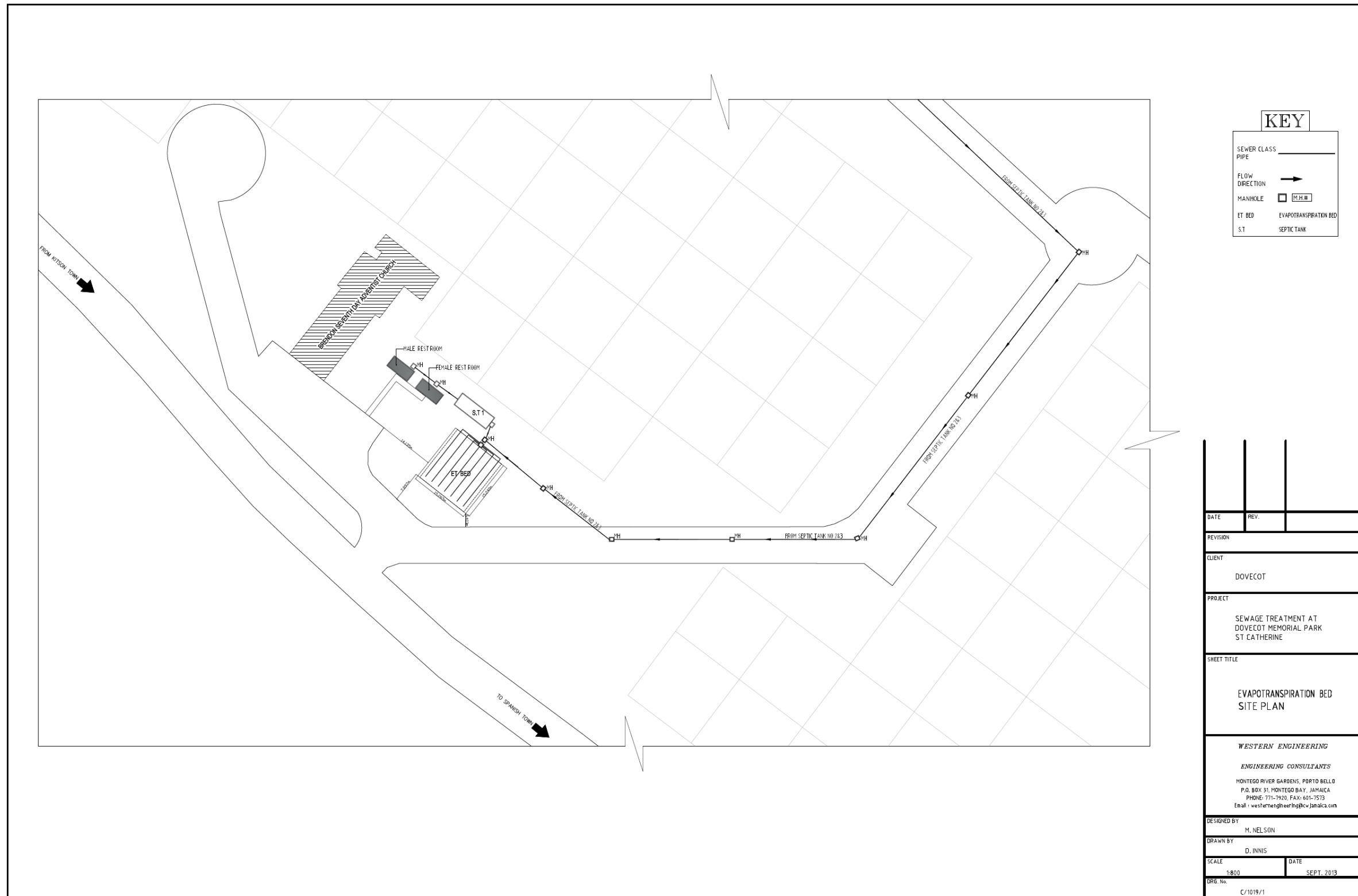

Figure 3-5 The location of the lower rest room showing the septic tank, the flow from septic tanks 2 and 3 and the evapotranspiration bed

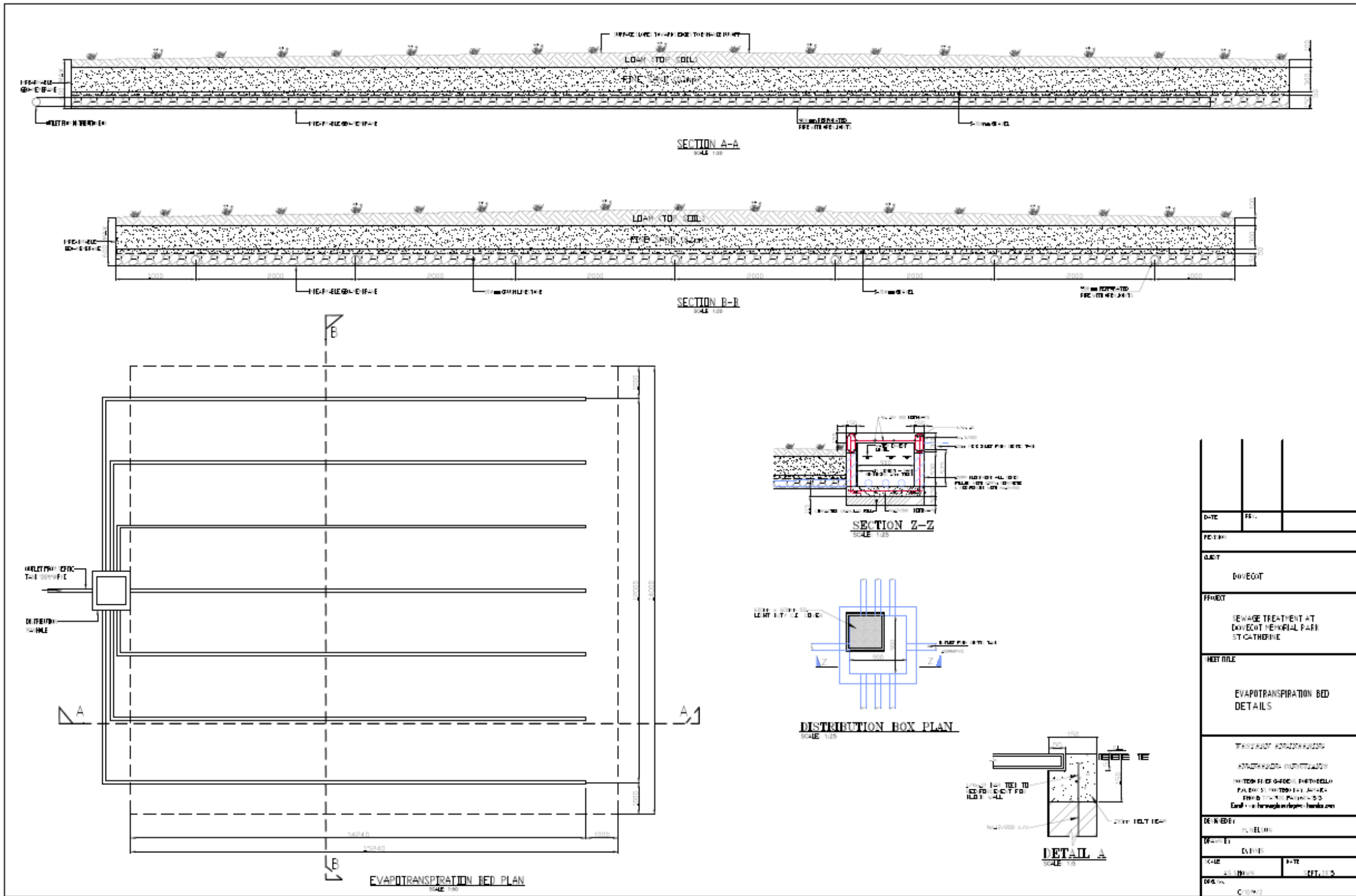

Figure 3-6 Schematic showing the layout of the evapotranspiration bed

DATE	REV.	
PROJECT		
DOVECOT		
PROJECT		
SEWAGE TREATMENT AT DOVECOT MEMORIAL PARK, ST CATHERINE		
SHEET TITLE		
EVAPOTRANSPIRATION BED DETAILS		
DESIGNED BY: KUMANDA PARK LIMITED		
DRAWN BY: KUMANDA PARK LIMITED		
CHECKED BY: KUMANDA PARK LIMITED		
DATE: 10/11/2023		
SCALE: 1:25		
DRAWN BY: CL ENVIRONMENTAL CO. LTD.		

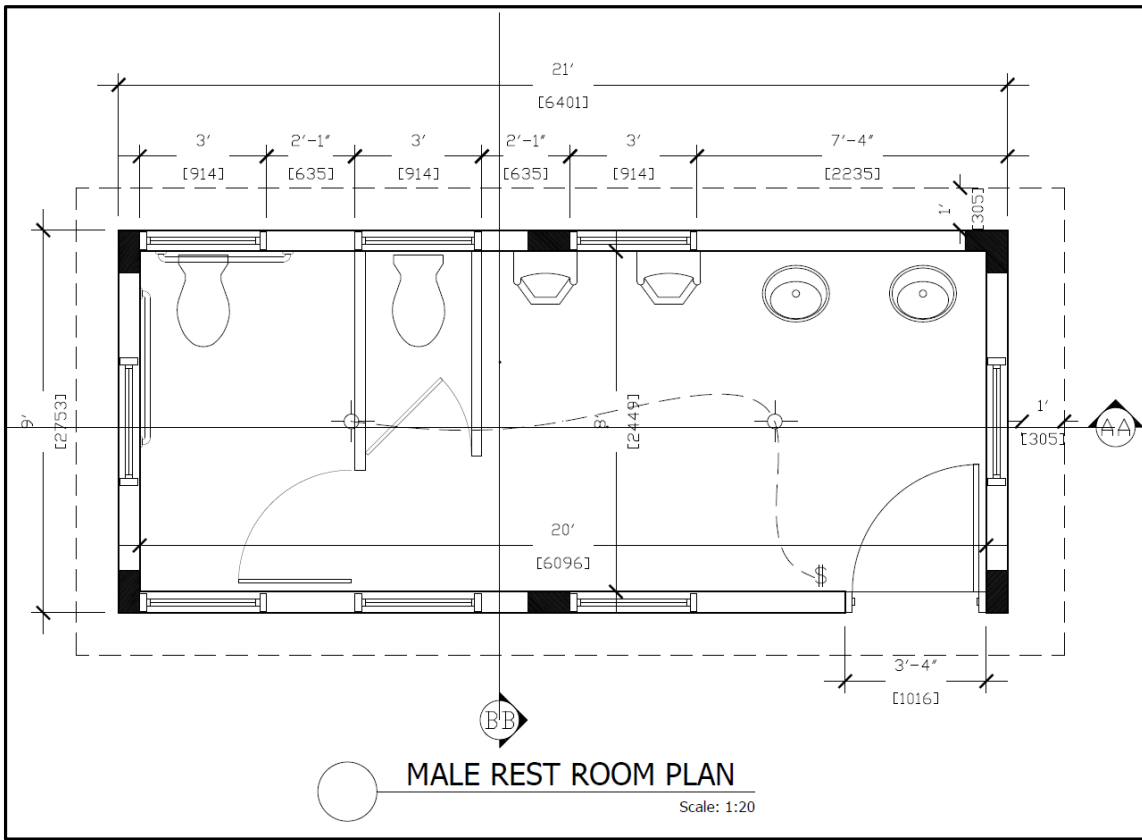

Figure 3-7 Plan view of the male restroom

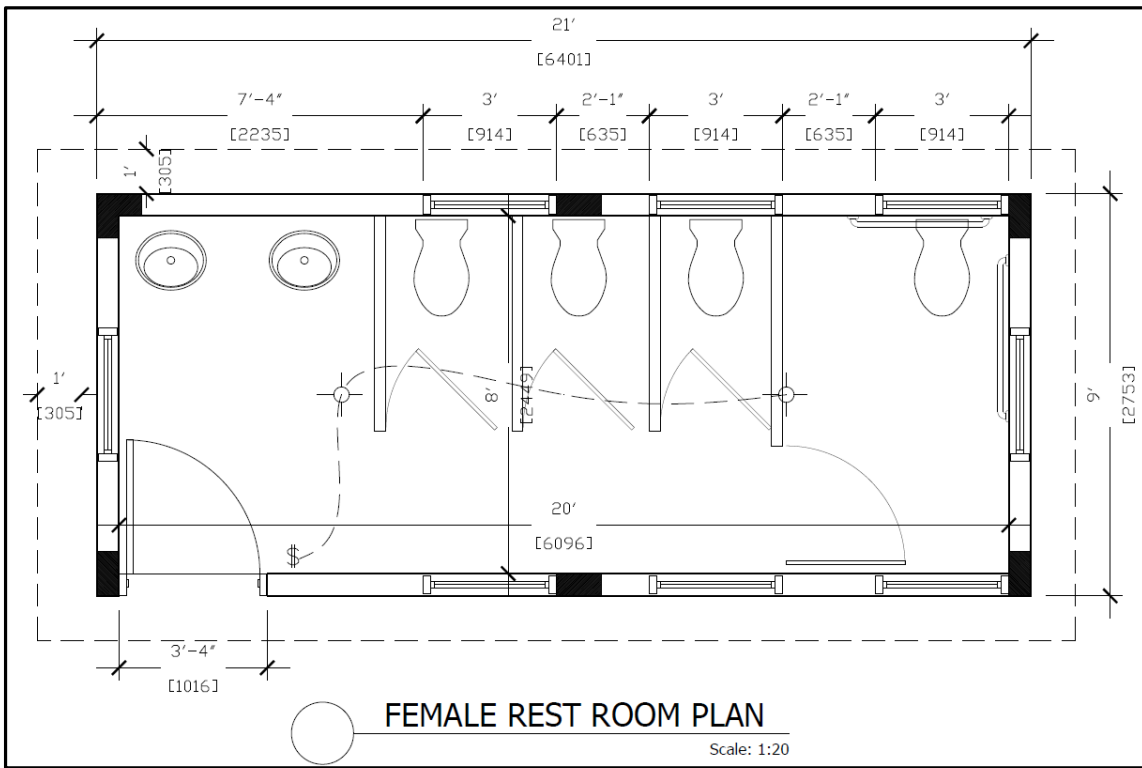

Figure 3-8 Plan view of the female restroom

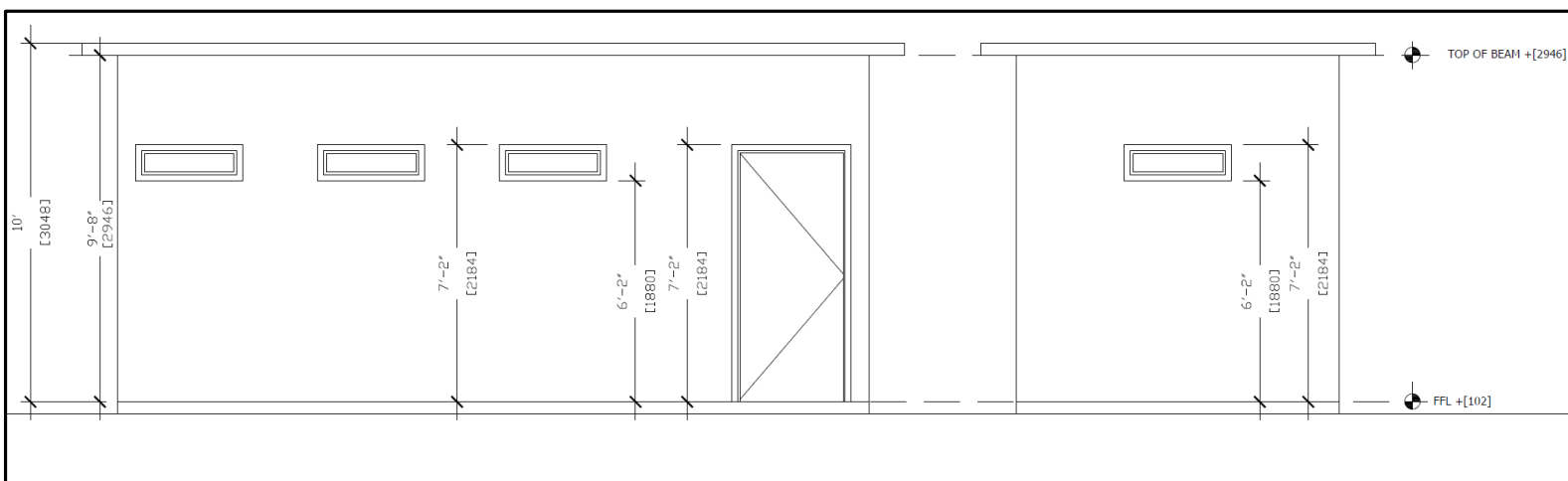

Figure 3-9 Front elevation of the typical restroom building

### **3.4.5 Drainage System**

The proposed project will maintain the existing natural drainage conditions. Hardscape areas such as roads and parking lot will capture surface water via curbs and channels and deposit in soak wells or sinkholes.

### **3.4.6 Site Access**

The proposed site will be accessed from St. Johns Road in proximity to the existing Bendon Seventh Day Adventist Church. From there, clients will be able to drive to the required burial locations by using the road network laid out (Figure 3-10).

There is a proposed service entrance to the northern side of the property.

### **3.4.7 Equipment**

The equipment needed for the efficient running of the cemetery include an excavator, a frontend loader, weed wackers, lawnmowers and machetes. The excavator and frontend loaders will be used for the construction of the grave whilst the weed wackers, lawnmowers and machetes used for the maintenance of the lawns and verges. They will be used on an as needed basis. The smaller equipment will be stored towards the northern boundary of the site in a storage shed and the excavator and frontend loader will be kept on the existing Dovecot property.

Schematics of the proposed storage shed are depicted in Figure 3-11.



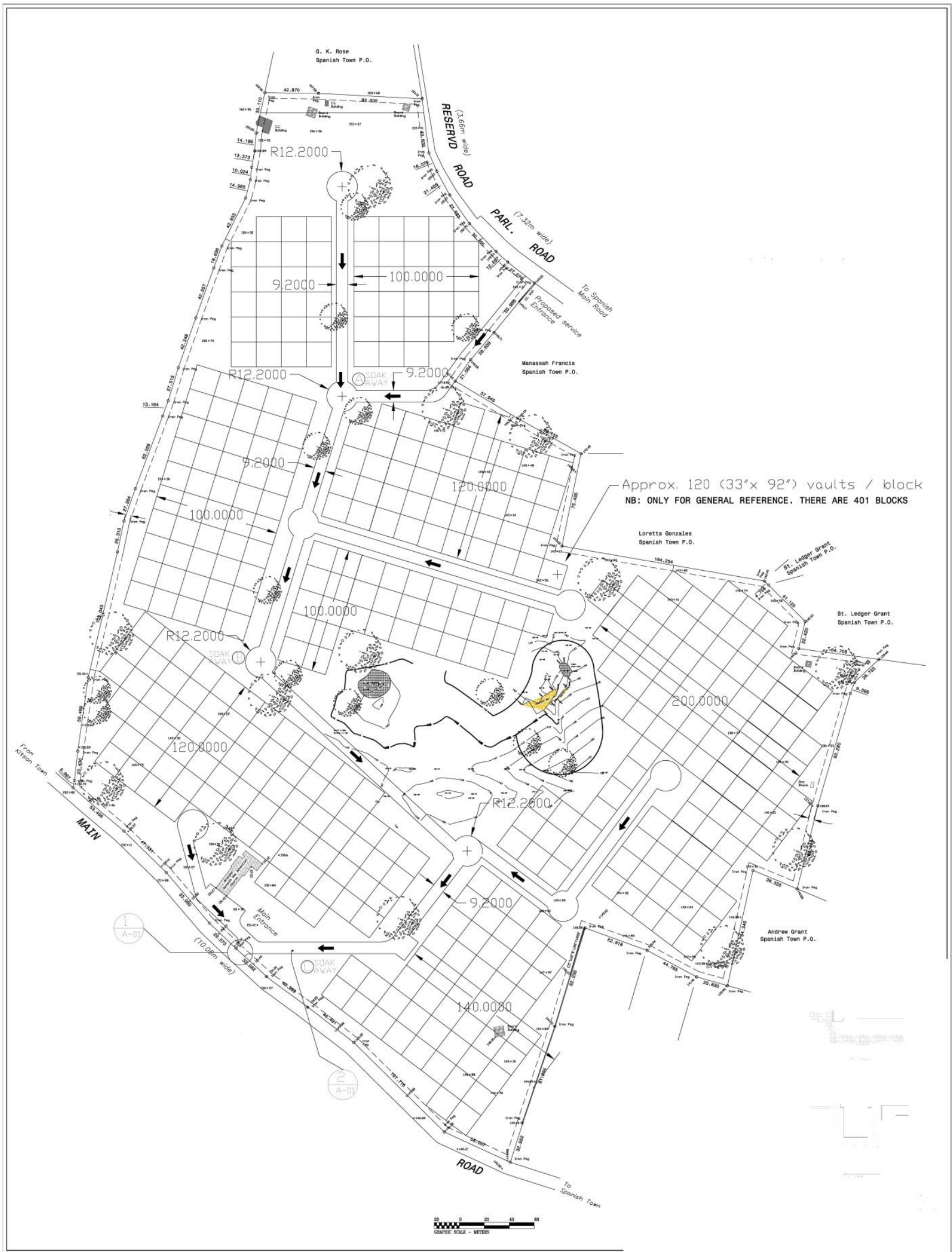

Figure 3-10 Proposed layout of the Dovecot expansion project



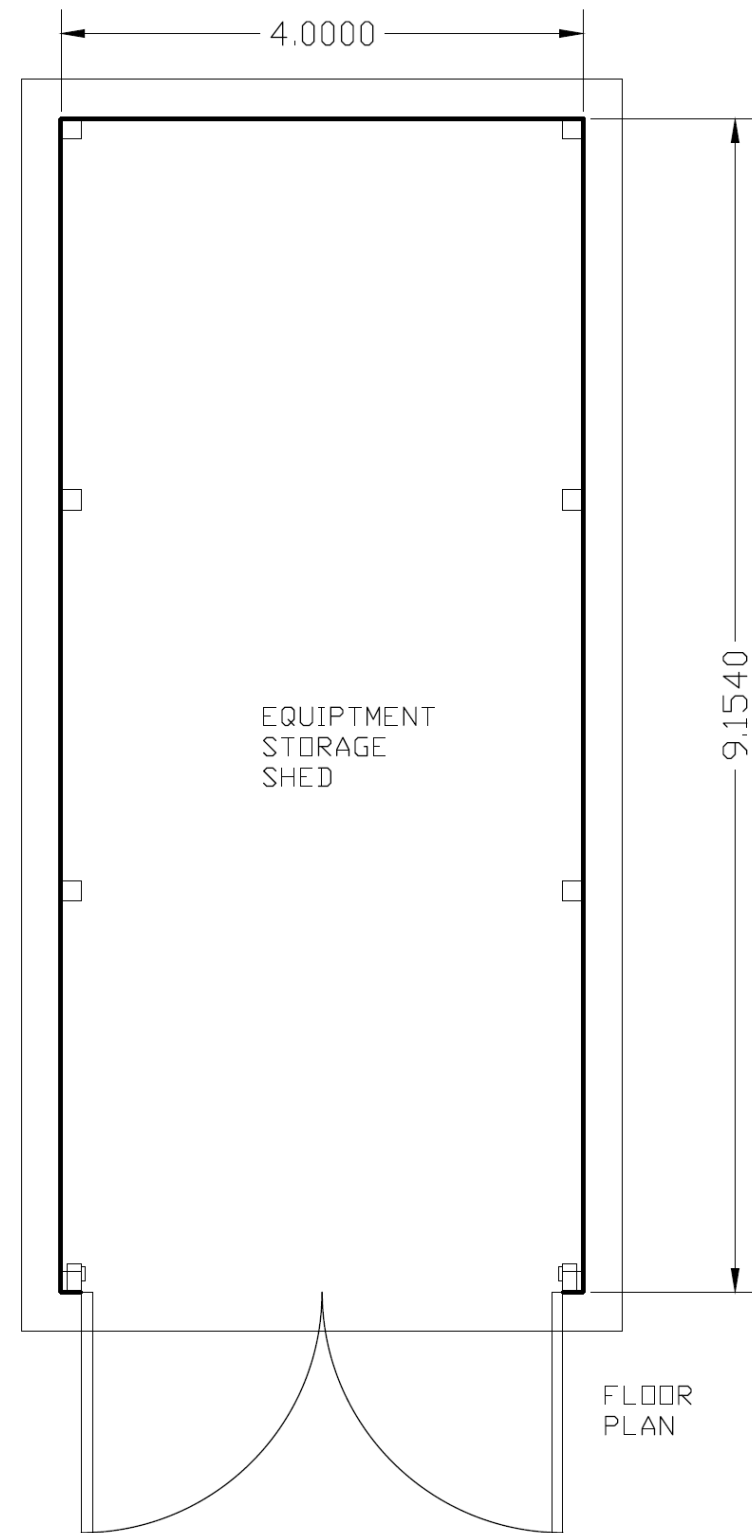
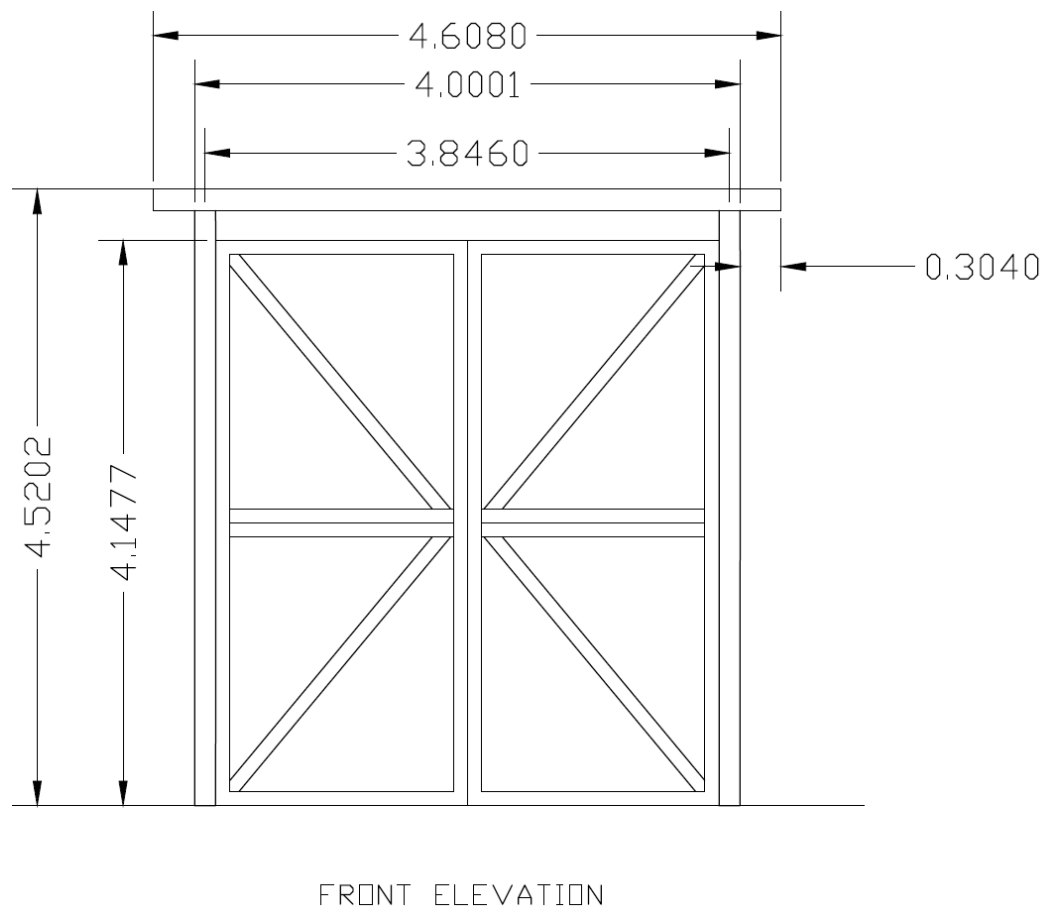
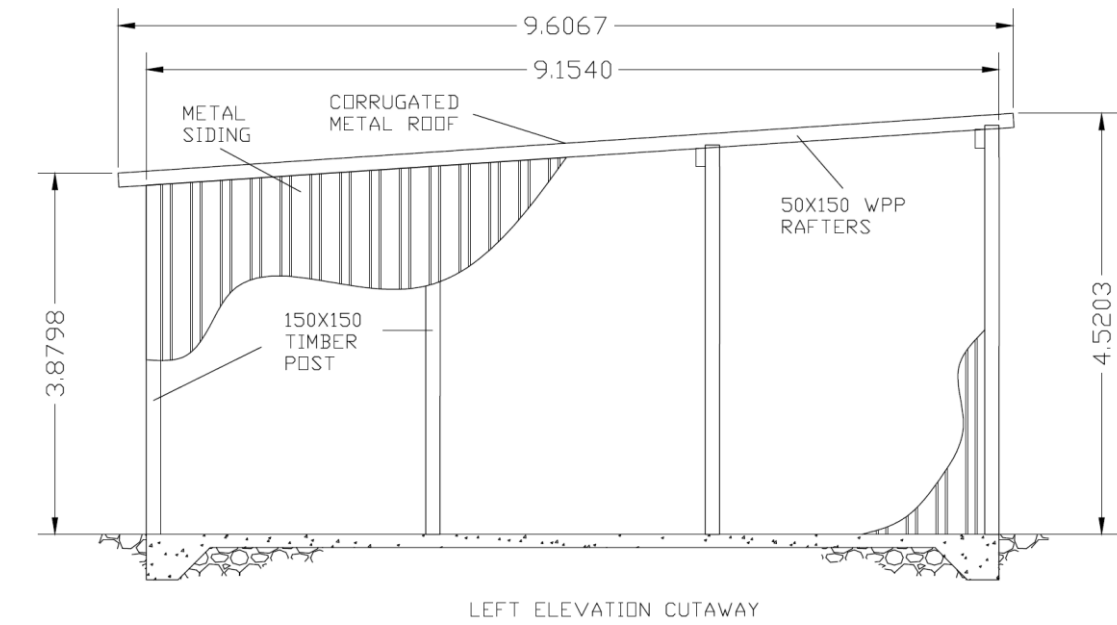

Figure 3-11 Storage shed views

### 3.4.8 Employment

The preparation of the land and burial sites will provide employment for approximately 30 persons broken down into 18 persons for site preparation (e.g. excavator operator, bushing etc.) and 12 masons for the preparation of the vaults.

### 3.4.9 Pest Control

Common sense approaches will be used at the proposed cemetery to control pests. These include the adequate collection, storage and removal of waste as outlined in Section 3.4.4 and periodically contracting a pest control company to treat any problem that might occur.

## 3.5 PROJECT PHASES AND SCHEDULE

Once approved, the project will commence by the creation of the parking area, roads, drainage and sewage system and the clearance of approximately 1.2 ha (=3 acres) for the development of burial plots. This phase is expected to take 6-8 months after the necessary loans are secured.

After the initial phase, the land will be cleared at approximately 1.2 ha (=3 acres) at a time until the entire area is used up. It is anticipated as stated above, that the entire project will have a lifespan of approximately 48 years. It is envisioned that the site will be cleared in 12 phases as illustrated in Figure 3-12.

During the construction of the graves site clearance will occur which will remove dirt and vegetation (including trees). The top soil and smaller vegetation (mulch/conditioner) will be set aside to be reused in landscaping while the larger trees will be given to charcoal burners in the area to be used.



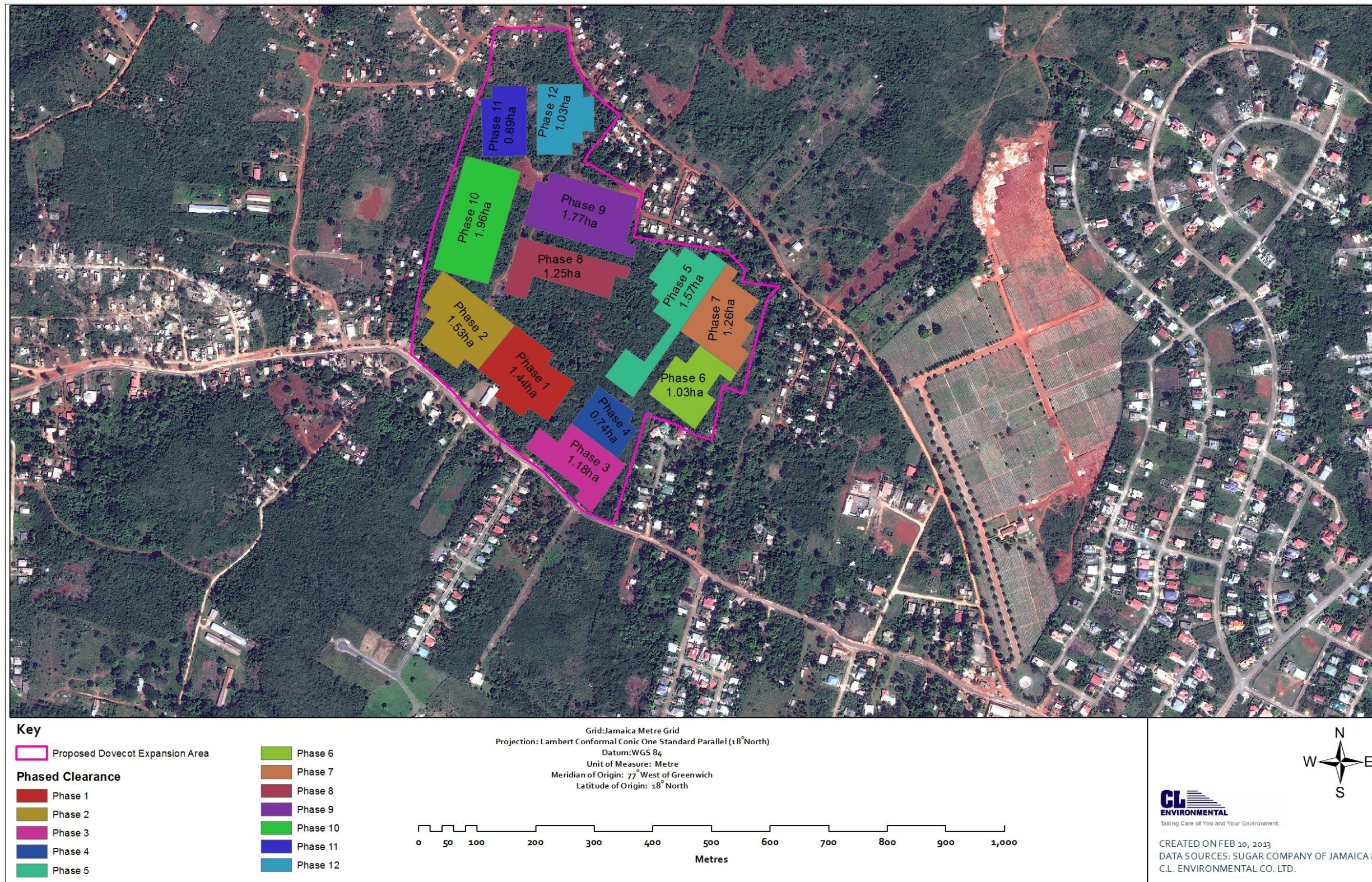

Figure 3-12 Proposed phased clearing of the site



## 4.0 DESCRIPTION OF THE EXISTING ENVIRONMENT

### 4.1 PHYSICAL

#### 4.1.1 Climatology and Meteorology

##### 4.1.1.1 Meteorological Stations within Study Area

###### Methodology

Temperature, relative humidity, wind speed and direction, rainfall and barometric pressure were recorded at one location (Bendon Seventh Day Adventist Church, Station N1) over the noise and particulate monitoring period (Thursday March 6<sup>th</sup> to Tuesday March 18<sup>th</sup>, 2014) by using a Davis Instruments wireless Vantage Pro2 weather system with a data logger and a complete system shelter erected on a tripod. Data were collected every fifteen minutes and stored on the data logger. This information was downloaded using the WeatherLink 5.9.2 software.



Plate 4-1 Weather station deployed atop Bendon Seventh Day Adventist Church (Station 1)

###### Results

Average temperature over the monitoring period was 24.6 °C and ranged from a low of 18.4 °C to a high of 32.2 °C. Average relative humidity was 80.1% and ranged from a low of 44% to a high of 98%. Average wind speed was 0.6 m/s and ranged from a low of 0 m/s to a high of 9.4 m/s. Dominant wind direction was from the north northeast. Measurable precipitation during the monitoring period was 37.1 mm, with the two major rain days being March 8<sup>th</sup> (23.9mm) and March 15<sup>th</sup> (10.2mm). Barometric pressure ranged from a low of 1000.2 millibar to 1008 millibar,

### 4.1.2 Ambient Particulates (PM 2.5 & PM 10)

Coarse particles are airborne pollutants that fall between 2.5 and 10 micrometres in diameter. Fine particle are airborne pollutants that fall below 2.5 micrometres in diameter. Sources of coarse particles include crushing or grinding operations, and dust stirred up by vehicles traveling on roads. Sources of fine particles include all types of combustion, including motor vehicles, power plants, residential wood burning, forest fires, agricultural burning, and some industrial processes.

#### 4.1.2.1 Methodology

PM2.5 and PM10 particulate sampling was conducted for 24 hours each, using Airmetrics Minivol Tactical Air Samplers (Plate 4-2). Sampling was conducted at five (5) locations within the project environs. Noise readings were conducted at the same locations as the particulates. The PM10 sampling exercise was conducted from 12:00am – 12:00am on March 6<sup>th</sup>, 9<sup>th</sup> and 13<sup>th</sup>, 2014 and the PM2.5 sampling exercise was conducted from 12:00am – 12:00am on March 8<sup>th</sup>, 10<sup>th</sup> and 14<sup>th</sup>, 2014. The locations are illustrated in Figure 4-1, and coordinates in Table 4-1.

Table 4-1 Particulate and Noise sampling locations (coordinates shown are in JAD 2001)

Name	Easting (m)	Northing (m)
N3P3	747396.424625	651501.046018
N1P1	747434.251403	650999.321606
N2P2	747300.974362	651224.489661
N5P5	747697.999654	650958.637036
N4P4	747673.57852	651276.163742



Plate 4-2 Photo showing particulate sampler deployed



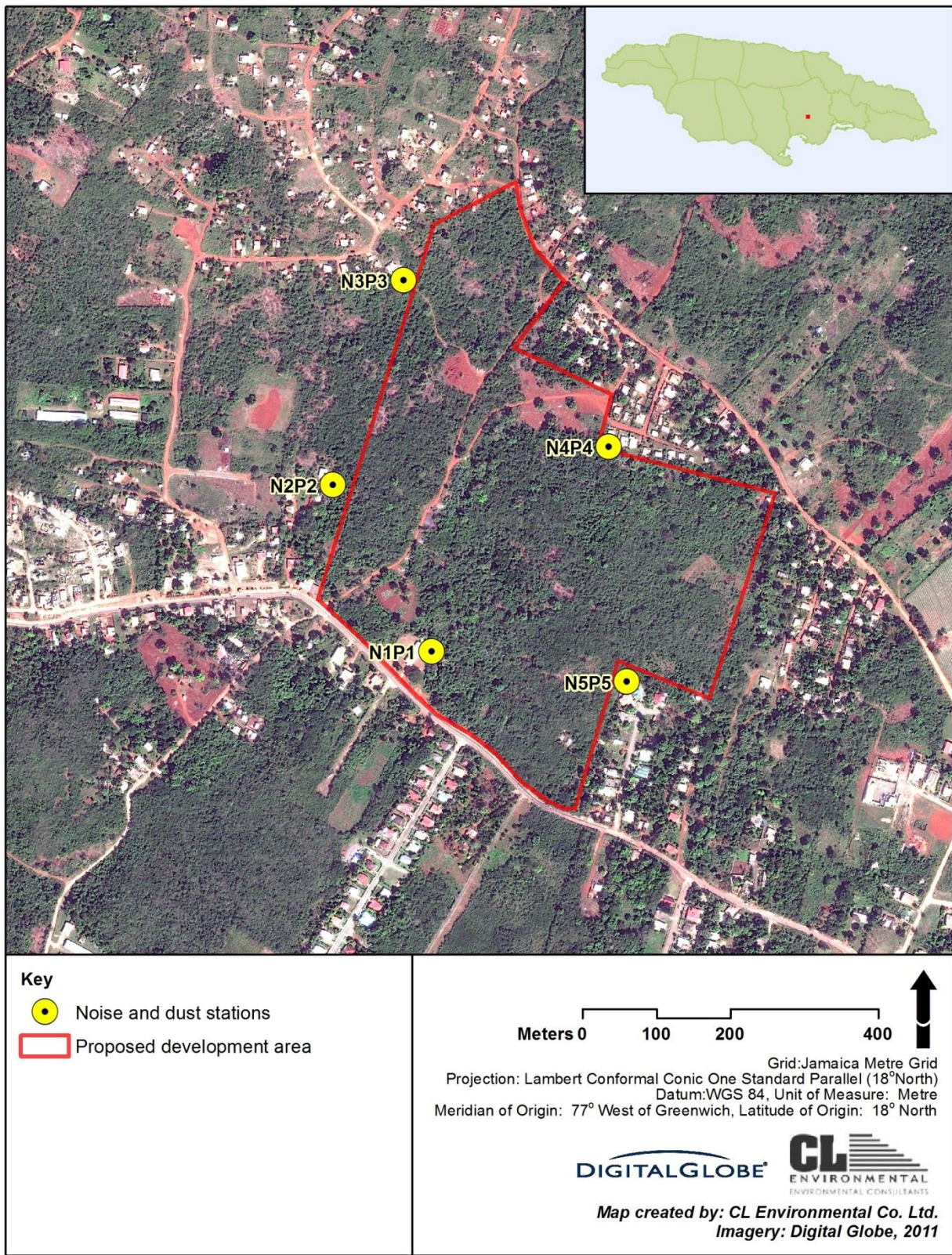

Figure 4-1 Map showing noise and particulate sampling locations

#### 4.1.2.2 Results

For the PM 10 sampling event all locations had average particulate values compliant with the 24-hour US EPA standard of 150µg/m<sup>3</sup>. Values ranged from 19.72 µg/m<sup>3</sup> at Station P2 to 23.84 µg/m<sup>3</sup> at Station P3. The results of the PM10 sampling runs are shown in Table 4-2 below.

Table 4-2 PM 10 Results

STATION	Average Result (µg/m <sup>3</sup> )	Range (µg/m <sup>3</sup> )	US EPA Std. (µg/m <sup>3</sup> )
P1	21.34	15 - 30.83	150
P2	19.72	9.86 - 30.42	150
P3	23.84	17.36 - 34.72	150
P4	20.74	15.56 - 31.11	150
P5	25.14	15.83 - 34.44	150

For the PM 2.5 sampling event all locations had average particulate values compliant with the 24-hour US EPA standard of 35 µg/m<sup>3</sup>. Values ranged from 7.41 µg/m<sup>3</sup> at Station P2 to 24.95 µg/m<sup>3</sup> at Station P1. An extreme value of 53.75 µg/m<sup>3</sup> at Station 1 on March 8<sup>th</sup> is possibly the result of burning occurring in the area, as smoke/soot has a high quantity of fine particulates. The results of the PM2.5 sampling runs are shown in Table 4-3 below.

Table 4-3 PM 2.5 Results

STATION	Average Result (µg/m <sup>3</sup> )	Range (µg/m <sup>3</sup> )	US EPA 24-hr Std. (µg/m <sup>3</sup> )
P1	24.95	9.86 - 53.75	35
P2	7.41	5.14 - 9.17	35
P3	12.12	5.97 - 18.33	35
P4	13.37	6.94 - 18.47	35
P5	8.24	5.14 - 12.22	35

### 4.1.3 Ambient Noise Climate

#### 4.1.3.1 Methodology

A data logging noise survey exercise was conducted to establish baseline conditions in the project environs. The noise data logging exercise was conducted for seventy two (72) hours between 7:00 hrs Saturday March 15<sup>th</sup> to 7:00 hrs Tuesday March 18<sup>th</sup>, 2014. The readings were taken at five (5) locations listed in Table 4-1 and depicted in Figure 4-1.

Noise level readings were taken by using Quest Technologies SoundPro DL Type 1 hand held sound level meters with real time frequency analyser setup in outdoor monitoring kits. The octave band analysis was conducted concurrently with the noise level measurements. Measurements were taken in the third octave which provided thirty three (33) octave bands from 12.5 Hz to 20 kHz (low, medium and high frequency bands). The noise meters were calibrated pre and post noise assessment by using a Quest QC - 10 sound calibrator (Appendix 4). The meters were programmed using the Quest suite Professional II (QSP II) software to collect third octave, average sound level (Leq) over the period, Lmin



(The lowest level measured during the assessment) and Lmax (The highest level measured during the assessment) every ten (10) seconds.

Average noise levels over the period were calculated within the QSP II software using the formula:

$$\text{Average dBA} = 20 \log \frac{1}{N} \sum_{j=1}^N 10^{(L_j/20)}$$

where  $N$  = number of measurements

$L_j$  = the  $j$ th sound level

$j = 1, 2, 3 \dots N$

A windscreen (sponge) was placed over the microphone to prevent measurement errors due to noise caused by wind blowing across the microphone. Plate 4-3 shows one of the noise monitoring outdoor kits.



Plate 4-3 Deployment of noise meter

#### 4.1.3.2 Results

This section outlines the results of the seventy two (72) hour noise monitoring exercise at the five (5) monitoring stations.

**Station 1**

During the 72-hour period, noise levels at this station ranged from a low (Lmin) of 30 dBA to a high (Lmax) of 81.2 dBA. Average noise level for this period was 53.6 LAeq (72h). The fluctuation in noise levels over the 72 hour period is depicted in Figure 4-2.

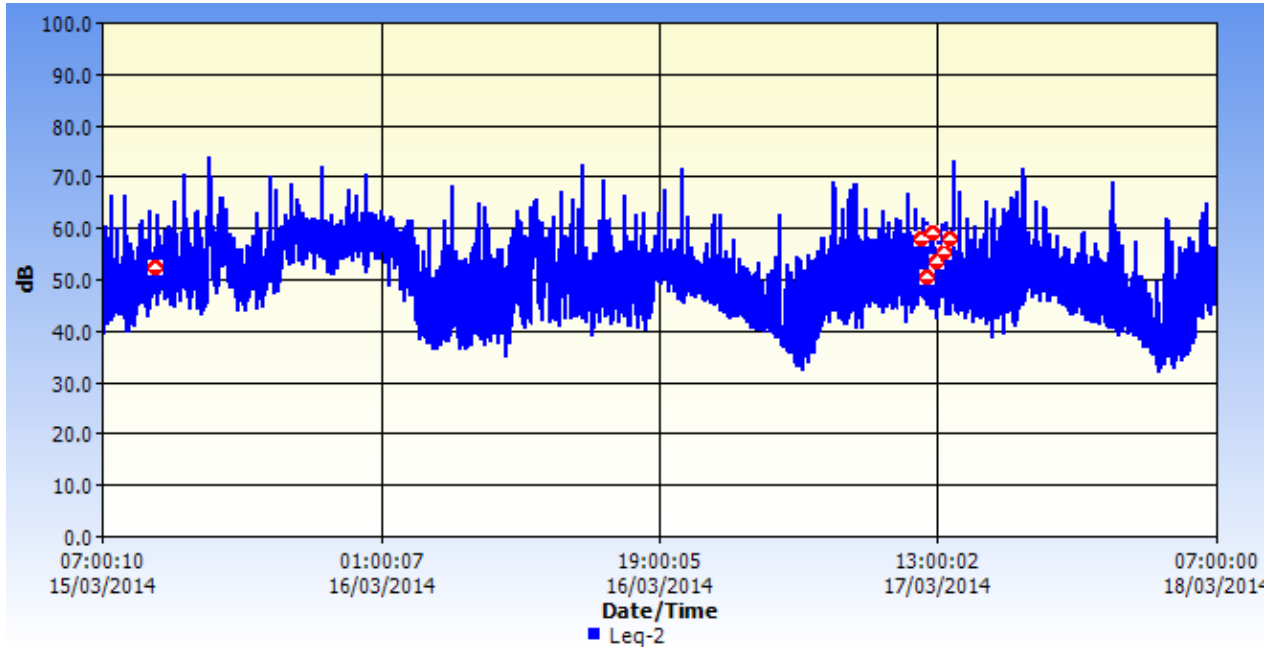

Figure 4-2 Noise fluctuation (Leq) over 72 hours at Station 1

*Octave Band Analysis at Station 1*

The noise at this station during the 72 hour period was in the low frequency band centred around the geometric mean frequency of 50 Hz. (octave frequency range is 45 - 56 Hz) (Figure 4-3).

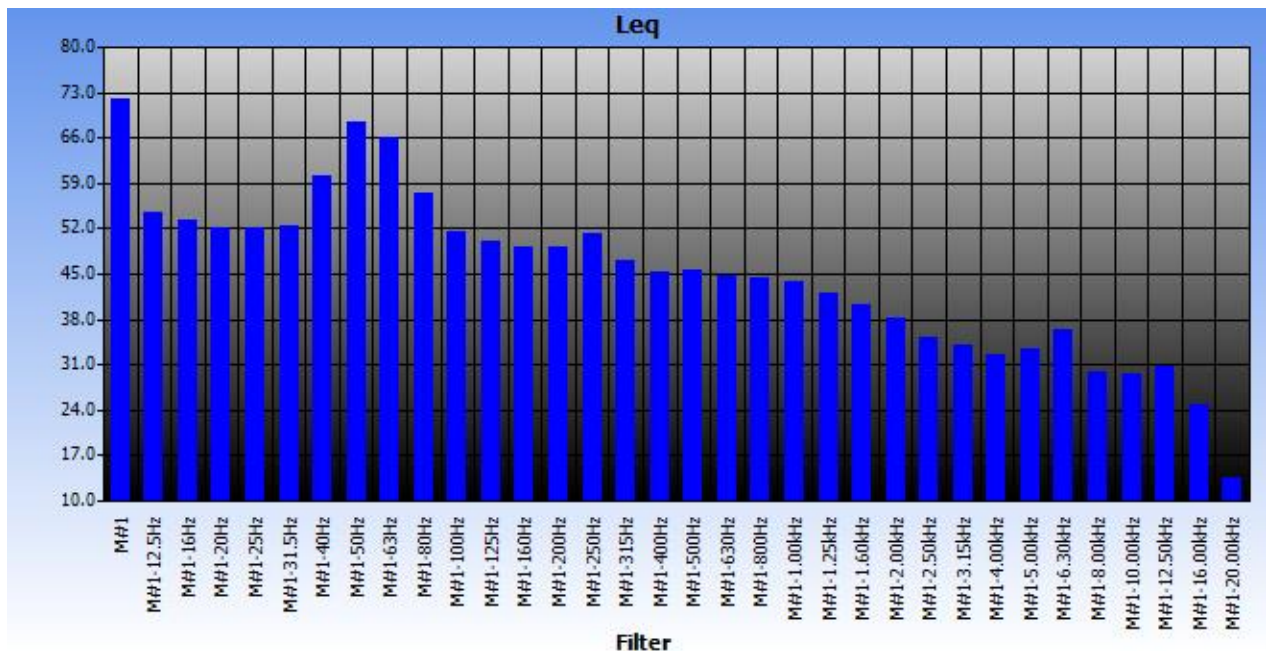

Figure 4-3 Octave band spectrum of noise at Station 1

**L10 and L90 – Station 1**

The two most common  $L_n$  values used are  $L_{10}$  and  $L_{90}$  and these are sometimes called the 'annoyance level' and 'background level' respectively.  $L_{10}$  is almost the only statistical value used for the descriptor of the higher levels, but  $L_{90}$ , is widely used to describe the ambient or background level.  $L_{10}$ - $L_{90}$  is often used to give a quantitative measure as to the spread or "how choppy" the sound was.

$L_{10}$  is the noise level exceeded for 10% of the time of the measurement duration. This is often used to give an indication of the upper limit of fluctuating noise, such as that from road traffic.  $L_{90}$  is the noise level exceeded for 90% of the time of the measurement duration. The difference between  $L_{10}$  and  $L_{90}$  gives an indication of the noise climate. When the difference is  $< 5$  dBA then it is considered that there are no significant fluctuations in the noise climate, moderate fluctuations 5-15 dBA and large fluctuations  $>15$  dBA.

Figure 4-4 depicts the hourly  $L_{10}$  and  $L_{90}$  statistics for this station over the noise assessment period. The data shows moderate fluctuations ( $L_{10} - L_{90}$ )  $\approx 77.8\%$  of the time, large fluctuations ( $L_{10} - L_{90}$ )  $\approx 4.2\%$  of the time and no significant fluctuations ( $L_{10} - L_{90}$ )  $\approx 18\%$  of the time in the noise climate at this station. The overall  $L_{10}$  and  $L_{90}$  at this station for the time assessed were 57.6 dBA and 41 dBA respectively.

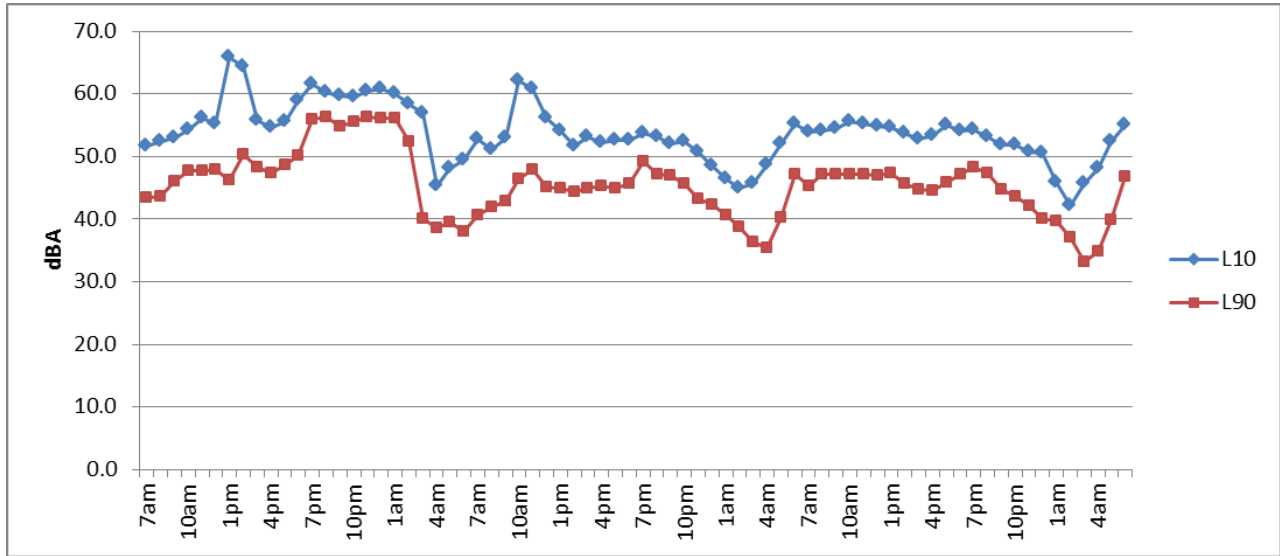

Figure 4-4 L10 and L90 for Station 1

**Station 2**

During the 72-hour period, noise levels at this station ranged from a low (Lmin) of 29.4 dBA to a high (Lmax) of 74.4 dBA. Average noise level for this period was 50.9  $L_{Aeq}$  (72h). The fluctuation in noise levels over the 72 hour period is depicted in Figure 4-5.

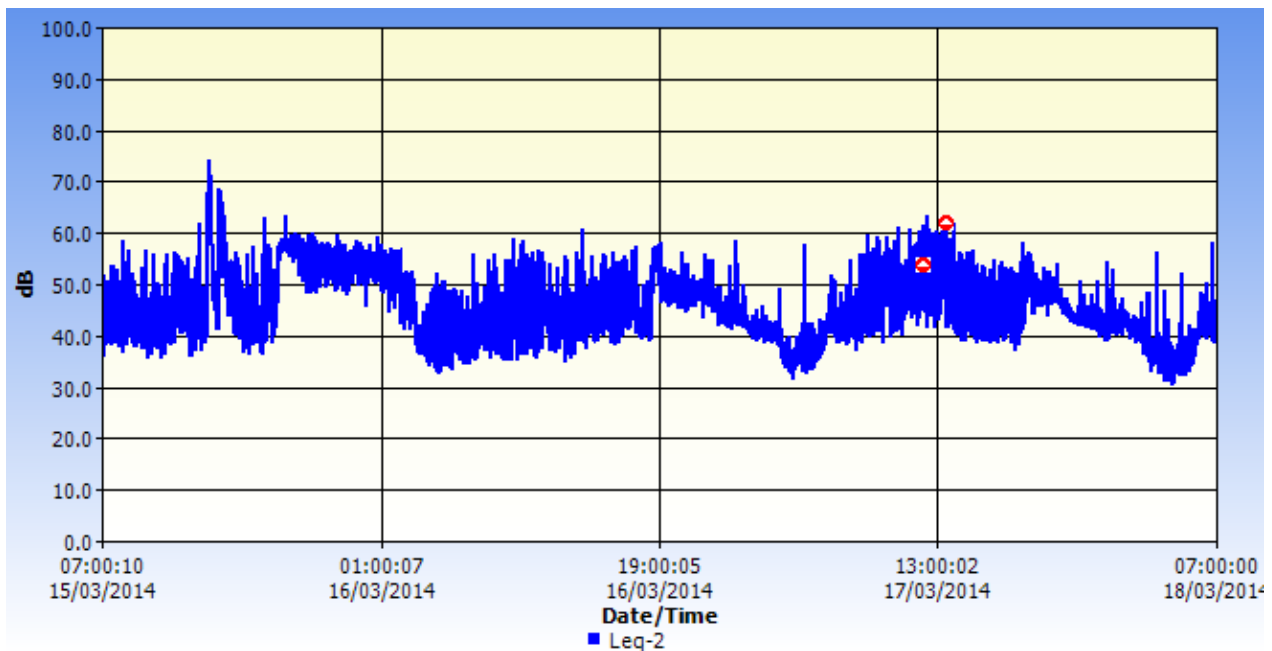

Figure 4-5 Noise fluctuation (Leq) over 72 hours at Station 2

**Octave Band Analysis at Station 2**

The noise at this station during the 72 hour period was in the low frequency band centred around the geometric mean frequency of 63 Hz. (octave frequency range is 56 - 71Hz) (Figure 4-6).

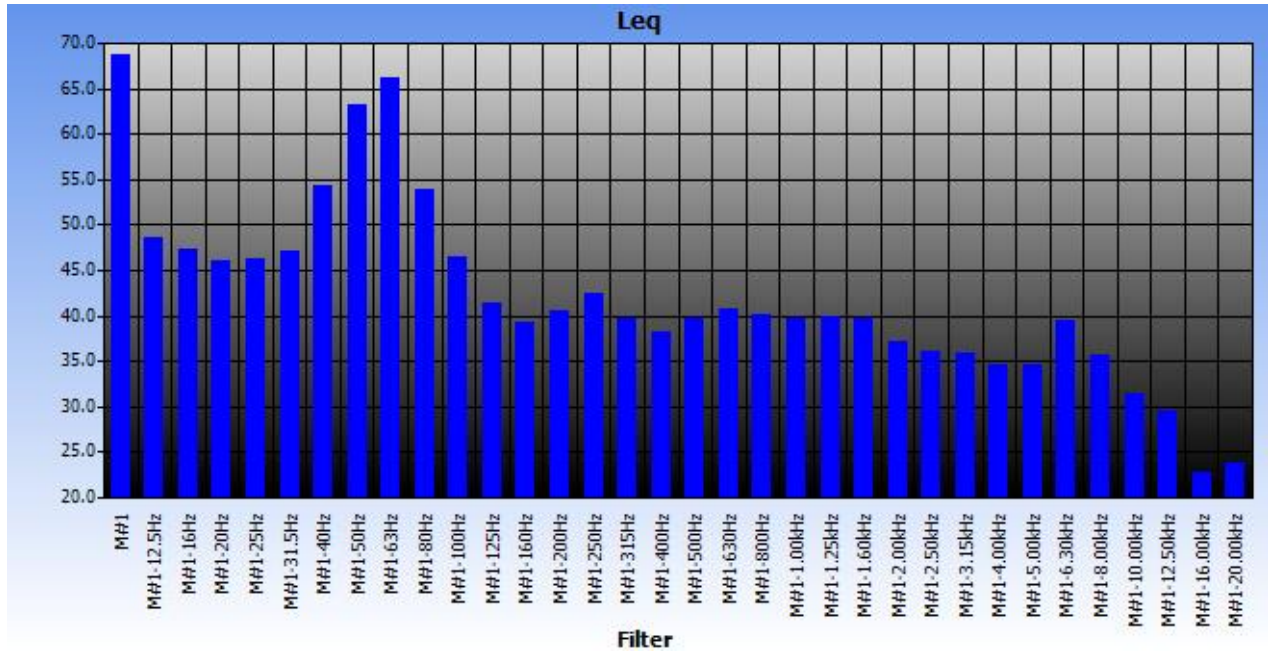

Figure 4-6 Octave band spectrum of noise at Station 2

**L10 and L90 – Station 2**

Figure 4-7 depicts the hourly L10 and L 90 statistics for this station over the noise assessment period. The data shows moderate fluctuations in the noise climate (L10 – L90) ≈66.67% of the time, no significant fluctuations ≈29.2% of the time and large fluctuations (L10 – L90) ≈4.13% of the time in the noise climate at this station.

The overall L10 and L 90 at this station for the time assessed were 54.1dBA and 37.8 dBA respectively.

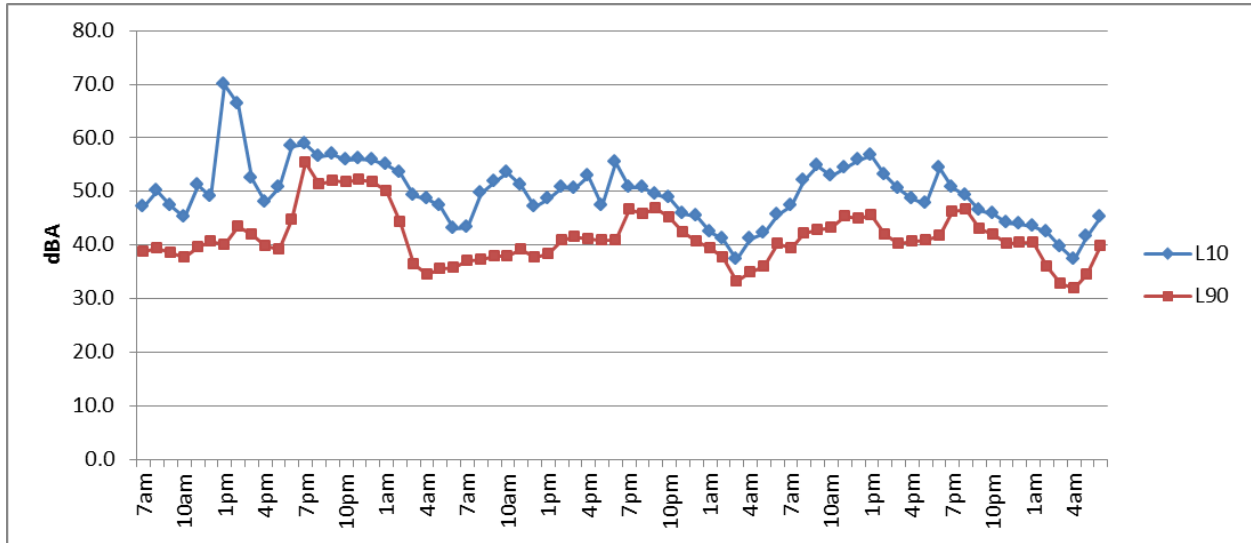

Figure 4-7 L10 and L90 for Station 2

**Station 3**

During the 72-hour period, noise levels at this station ranged from a low (Lmin) of 27.7 dBA to a high (Lmax) of 82.8 dBA. Average noise level for this period was 55.2 LAeq (72h). The fluctuation in noise levels over the 72 hour period is depicted in Figure 4-8.

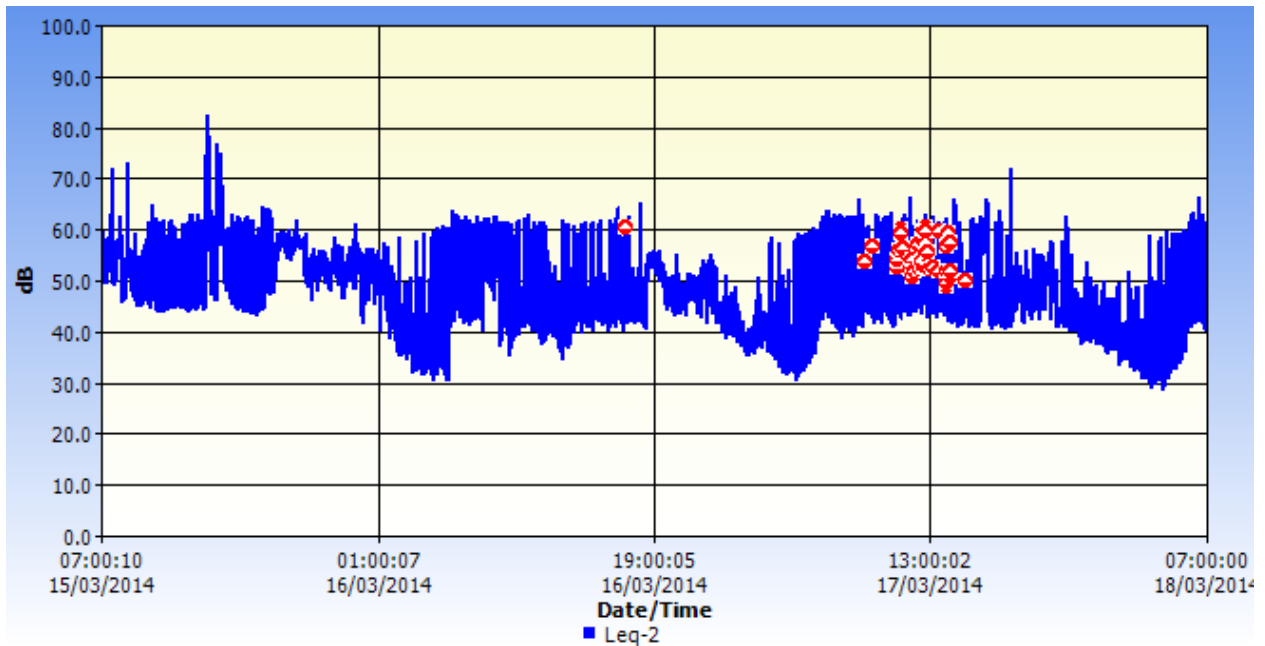

Figure 4-8 Noise fluctuation (Leq) over 72 hours at Station 3

**Octave Band Analysis at Station 3**

The noise at this station during the 72 hour period was in the low frequency band centred around the geometric mean frequency of 12.5 Hz. (octave frequency range is 11 - 14 Hz) (Figure 4-9).

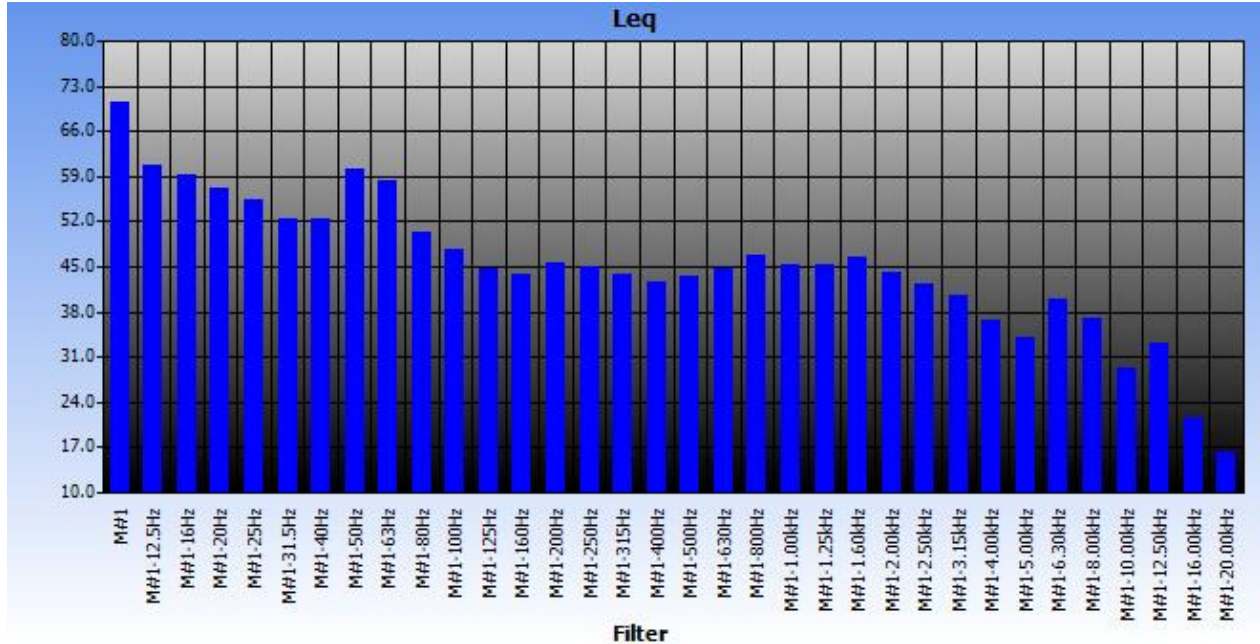

Figure 4-9 Octave band spectrum of noise at Station 3

**L10 and L90 – Station 3**

Figure 4-10 depicts the hourly L10 and L 90 statistics for this station over the noise assessment period. The data shows moderate fluctuations in the noise climate (L10 – L90) ≈70.8% of the time, large fluctuations in the noise climate (L10 – L90) ≈18% of the time and no significant fluctuations (L10 – L90) ≈11.2% of the time in the noise climate at this station.

The overall L10 and L 90 at this station for the time assessed were 56.1 dBA and 37.3 dBA respectively.



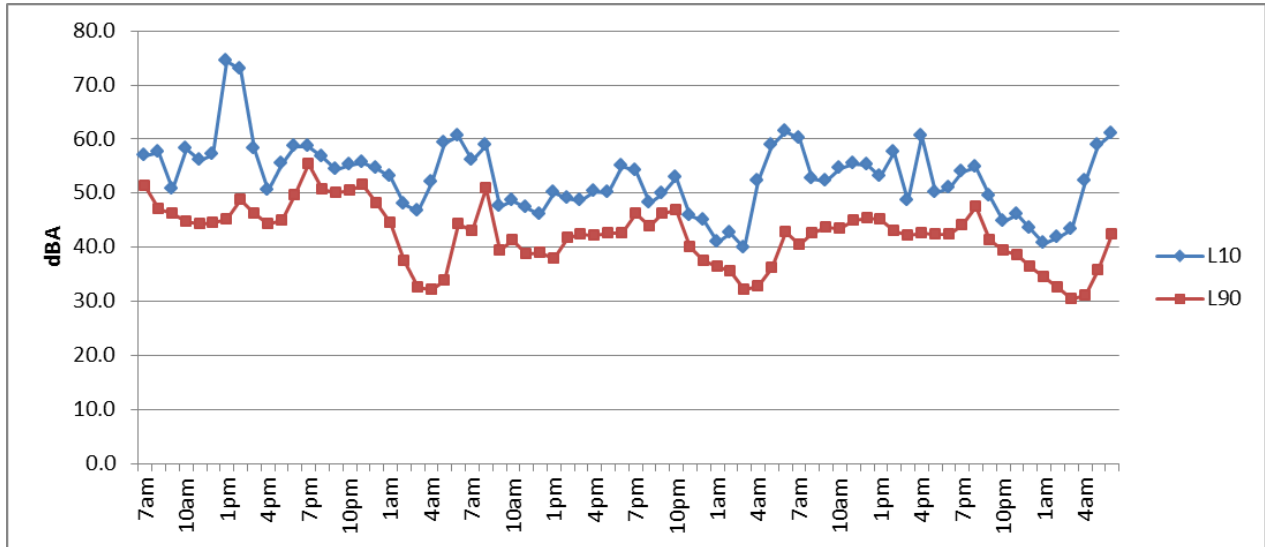

Figure 4-10 L10 and L90 for Station 3

#### Station 4

During the 72-hour period, noise levels at this station ranged from a low (Lmin) of 28.2 dBA to a high (Lmax) of 78.7 dBA. Average noise level for this period was 49.7 L<sub>Aeq</sub> (72h). The fluctuation in noise levels over the 72 hour period is depicted in Figure 4-11.

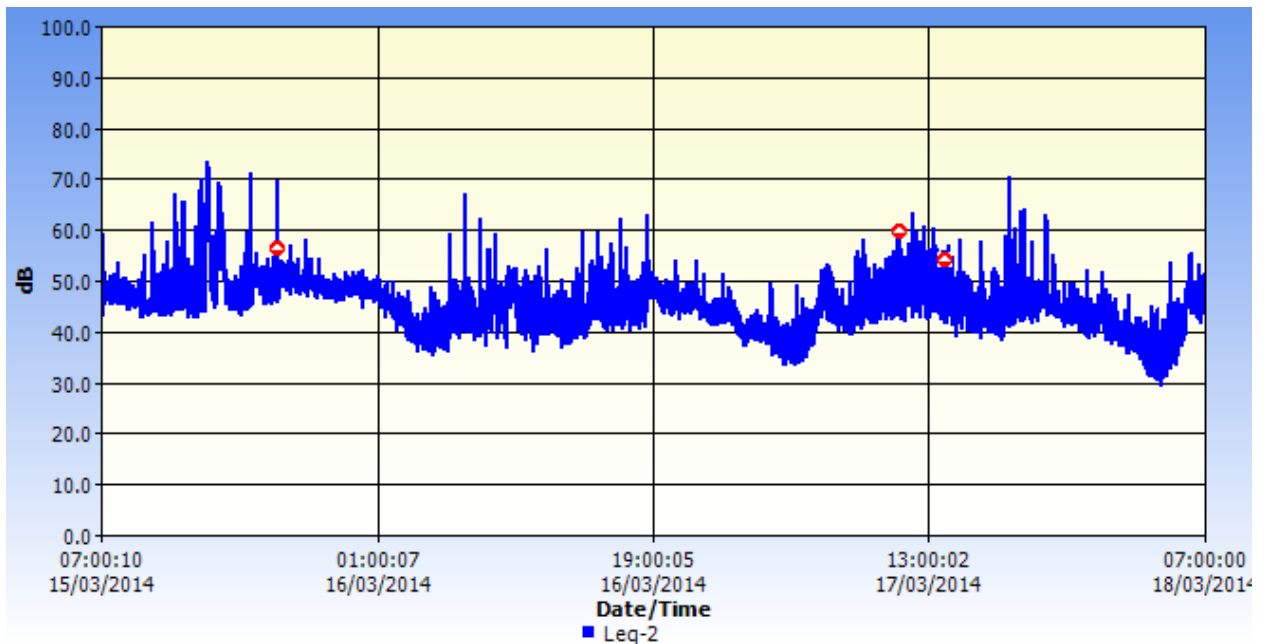

Figure 4-11 Noise fluctuation (Leq) over 72 hours at Station 4

**Octave Band Analysis at Station 4**

The noise at this station during the 72 hour period was in the low frequency band centred around the geometric mean frequency of 50 Hz. (octave frequency range is 45 - 56 Hz) (Figure 4-12).

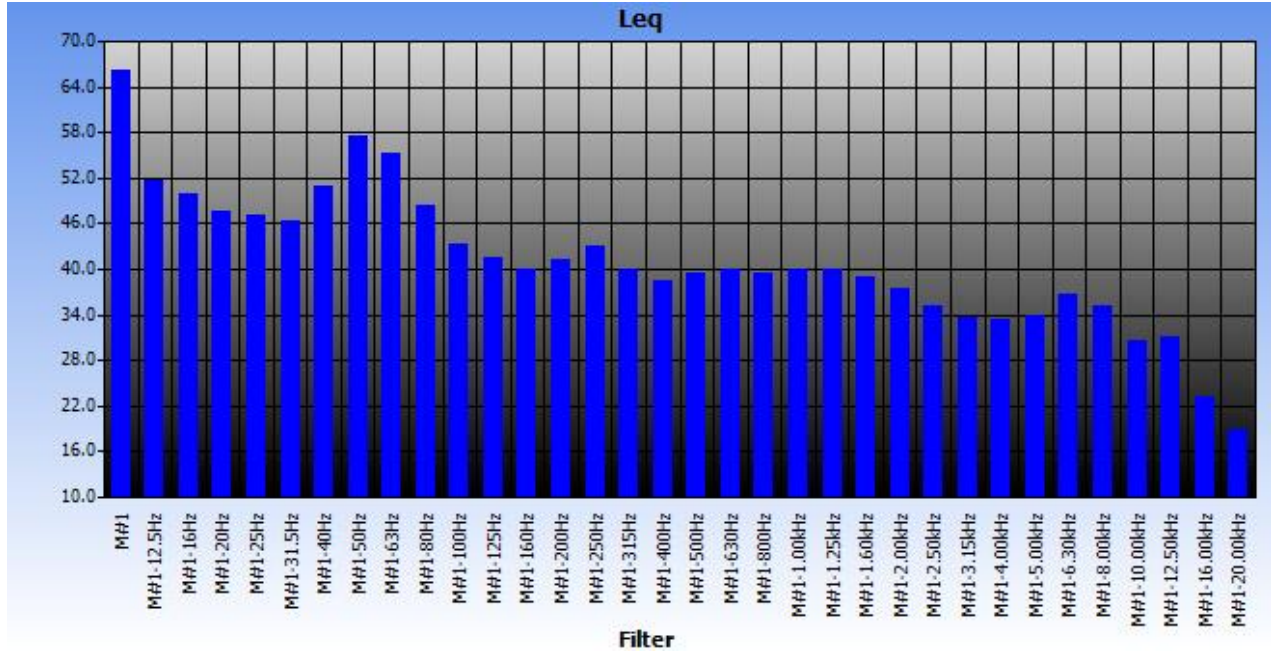

Figure 4-12 Octave band spectrum of noise at Station 4

**L10 and L90 – Station 4**

Figure 4-13 depicts the hourly L10 and L 90 statistics for this station over the noise assessment period. The data shows moderate fluctuations in the noise climate (L10 – L90) ≈58.3% of the time, large fluctuations in the noise climate (L10 – L90) ≈2.7% of the time and no significant fluctuations (L10 – L90) ≈39% of the time in the noise climate at this station.

The overall L10 and L 90 at this station for the time assessed were 50 dBA and 39.1 dBA respectively.

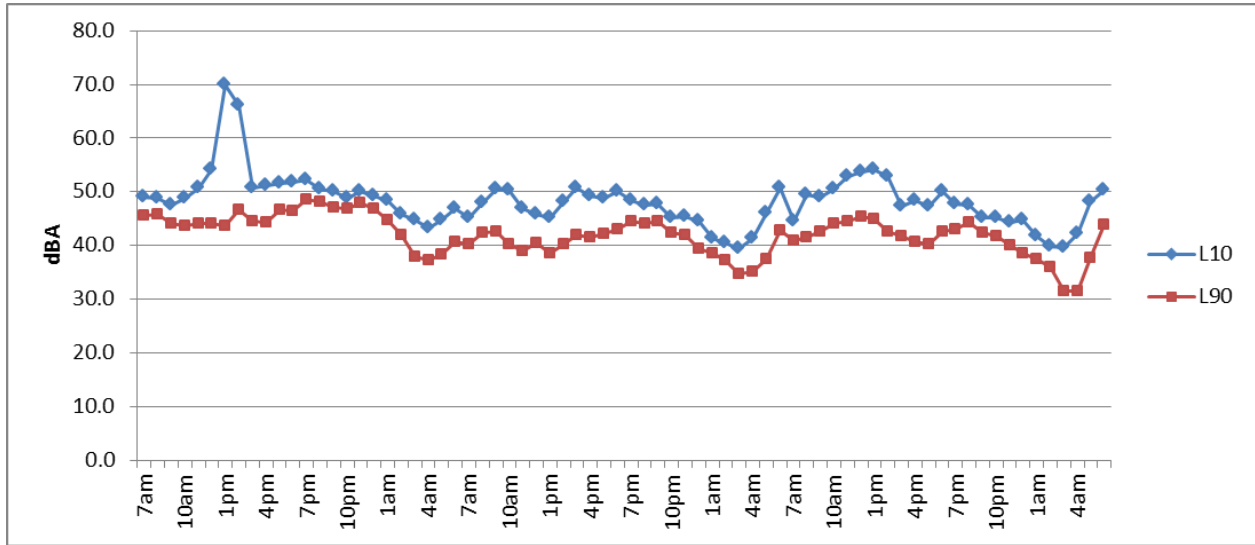

Figure 4-13 L10 and L90 for Station 4

**Station 5**

Due to equipment malfunction at this station, the noise data logging exercise only lasted 7 hours 23 minutes (7:00am – 2:23pm on March 15<sup>th</sup>)

During the period, noise levels at this station ranged from a low (Lmin) of 40 dBA to a high (Lmax) of 81 dBA. Average noise level for this period was 54.7 dBA. The fluctuation in noise levels over the period is depicted in Figure 4-14.

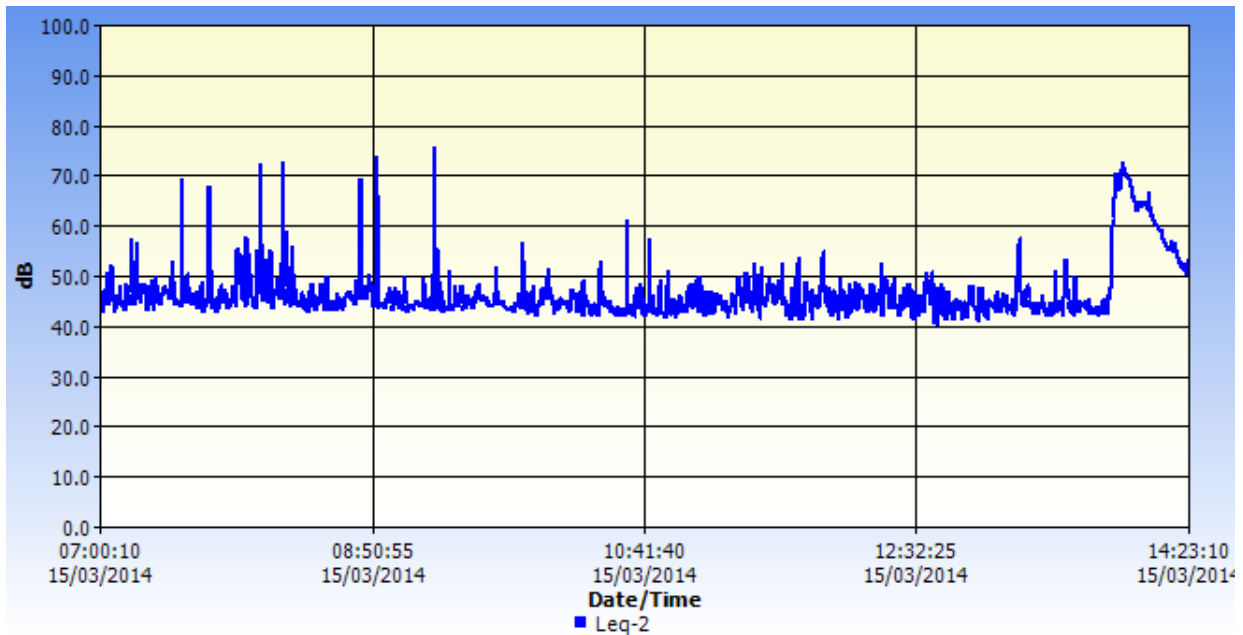

Figure 4-14 Noise fluctuation (Leq) at Station 5

**Octave Band Analysis at Station 5**

The noise at this station during the period was in the high frequency band centred around the geometric mean frequency of 50 Hz. (octave frequency range is 45 - 56 Hz) (Figure 4-15).

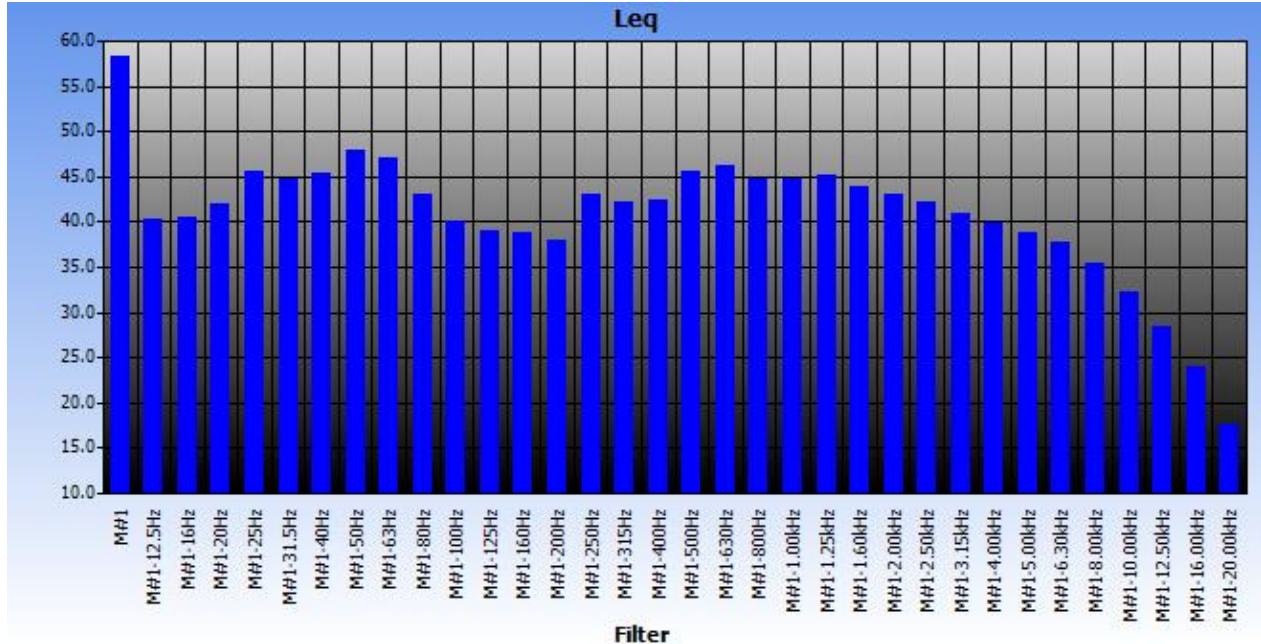

Figure 4-15 Octave band spectrum of noise at Station 5

**L10 and L90 – Station 5**

Figure 4-16 depicts the hourly L10 and L 90 statistics for this station over the noise assessment period. The data shows moderate fluctuations in the noise climate (L10 – L90) ≈50% of the time, large fluctuations in the noise climate (L10 – L90) ≈12.5% of the time and no significant fluctuations (L10 – L90) ≈37.5% of the time in the noise climate at this station.

The overall L10 and L 90 at this station for the time assessed were 51.2 dBA and 42.6 dBA respectively.

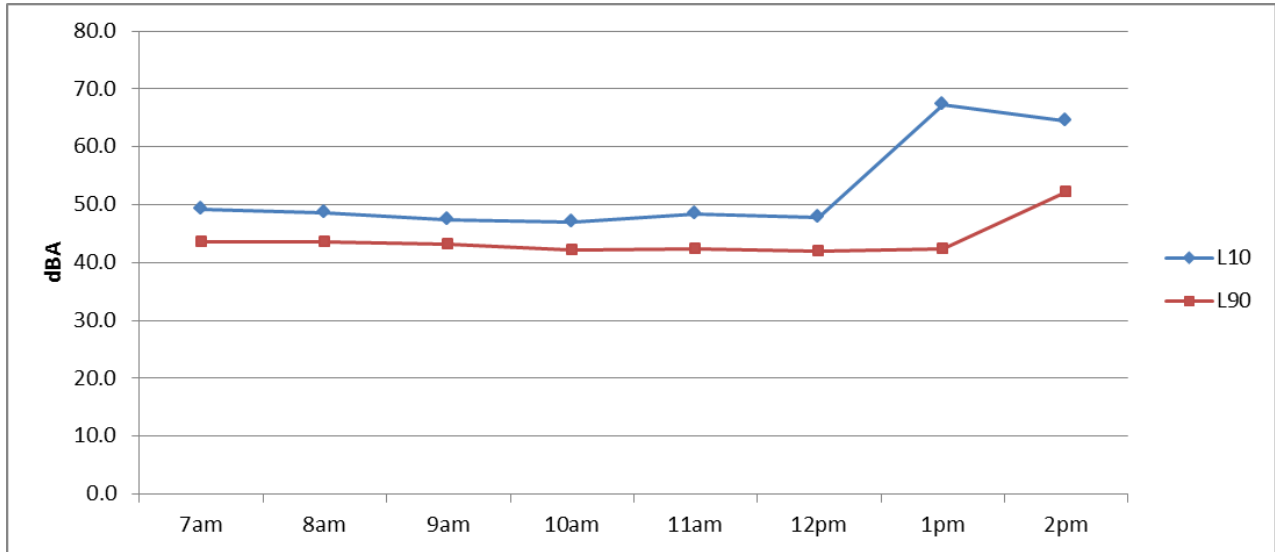

Figure 4-16 L10 and L90 for Station 5

#### 4.1.3.3 Comparisons of Ambient Noise Levels with NEPA Guidelines

Comparison of the ambient noise levels in the study area with the National Environmental and Planning Agency (NEPA) guidelines are shown in Table 4-4. Stations 1 and 3 had daytime and night time values non-compliant with the NEPA noise guidelines.

Table 4-4 Comparison of noise levels at the stations with the NEPA guidelines

Stn.#	Zone	7 am. - 10 pm (dBA)	NEPA Guideline (dBA)	10 pm. - 7 am (dBA)	NEPA Guideline (dBA)
1	Silence	54.2	45	52.5	40
2	Residential	52.2	55	47.5	50
3	Residential	56.8	55	50.2	50
4	Residential	51.3	55	44.3	50
5	Residential	54.7 (7 hrs 23 min)	55	N/A	50

NB. Numbers in red are non-compliant with the standard/guideline

#### 4.1.4 Topography and Morphology

The proposed cemetery is located in a NW-SE oriented valley on the southern edge of the limestone plateau which is bordered to the SE by the alluvial plain of the Rio Cobre River. In plan view the valley has a rectangular shape and runs parallel to the main structural features (faults) of the region. Except for the sudden changes of elevation at the beginning and the end, the valley has a fairly flat longitudinal profile between 90 and 60m a.m.s.l. with slopes of less than 5% (Figure 4-17). All this suggest that its morphology is mainly structurally controlled.

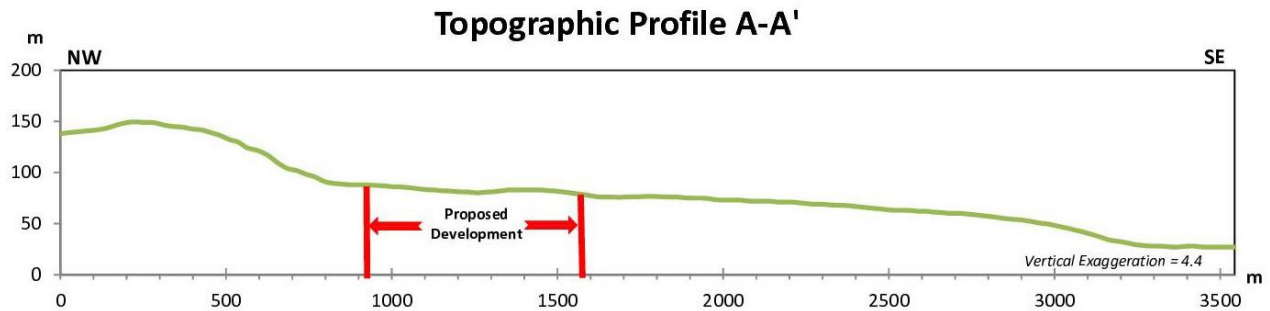

Figure 4-17 Topographic profile NW-SE (see Figure 4-18 for profile location)

The property for the proposed cemetery development is located in the upper section of this valley between the 96 and 74 m contour line. It is in general a near flat area enclosed on three sides, to the NW, the SW and the NE, by moderately steep slopes (Figure 4-19). About half of the property has slopes of less than 5% and about 32 percent of property has slopes between 5 and 10%. In fact about 95 percent of the property has slopes of less than 16% which are per definition of the “Hillside Development Manual of Jamaica” (MGD, 2011) “not considered as hillside slope”. The south-eastern boundary of the property is formed by a low ridge which runs perpendicular to the general topography and has an average elevation of 81m. Near the Kitson Town Main Road that ridge line is about 4 to 5m higher than the general topography. The difference in height between the ridgeline and the surrounding topography increases in North Easterly direction to a maximum of 10m near sinkhole #2 where the ridge comes to an end.



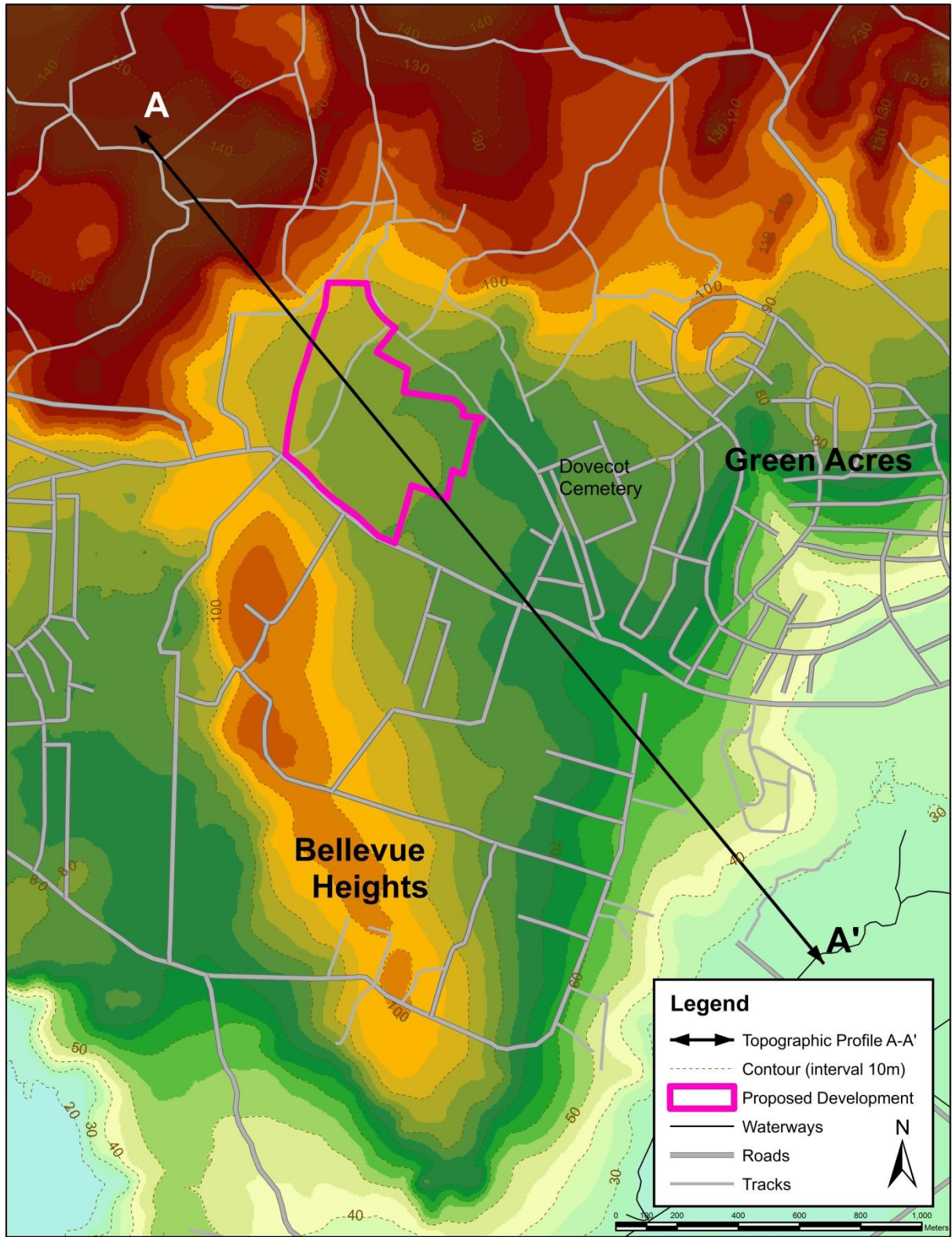

Figure 4-18 General topography of the region

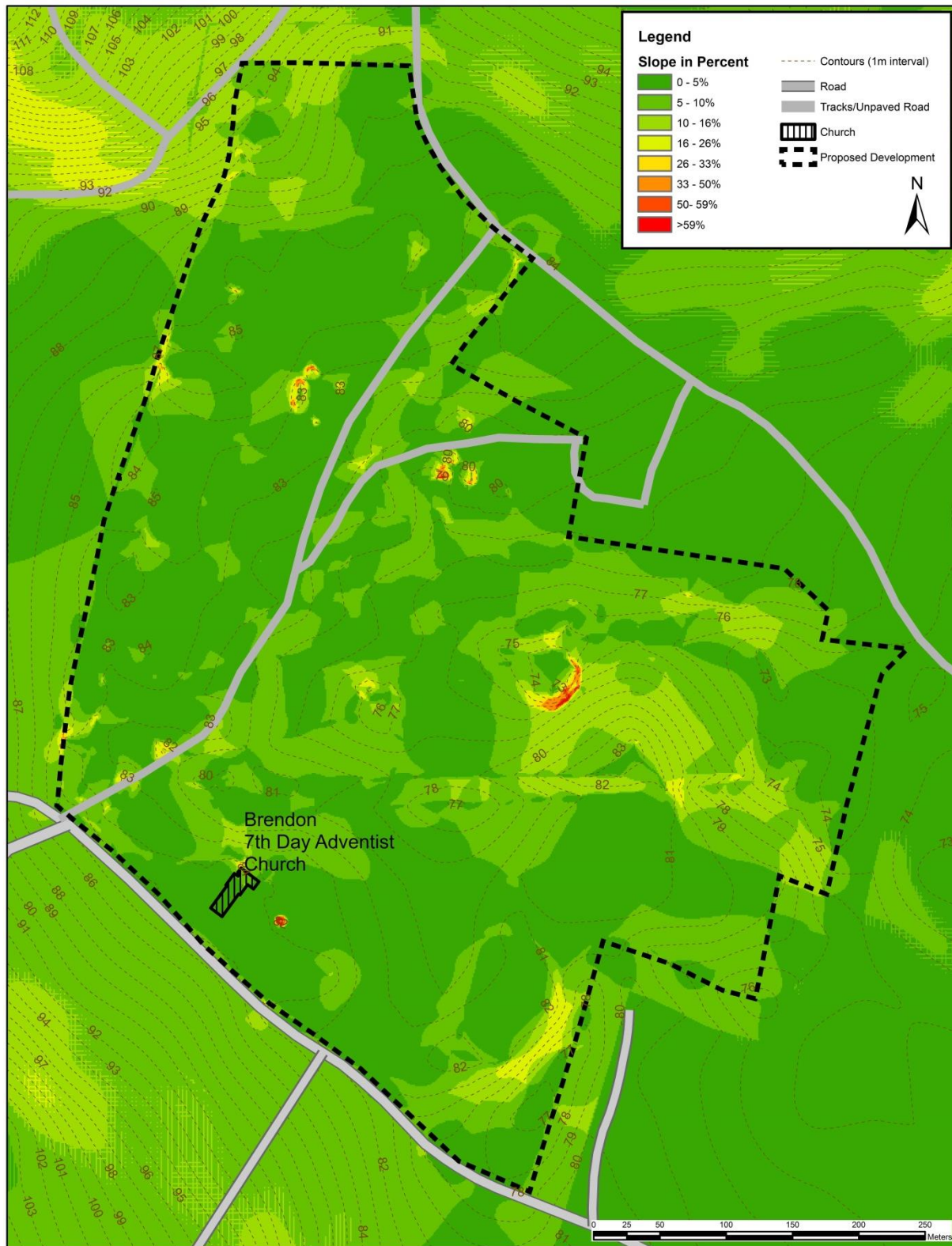

Figure 4-19 Slope map of the study area



Two (2) small sinkholes with a diameter of about 50m are located on the North Western side of the ridge (Figure 4-20). The sinkhole #1 is a distinct circular depression formed by karst (solution) processes in the North Western flank of the ridge. The limestone rocks exposed in the floor of the depression and in the near-vertical, 3m high half-circular outcrop in flank of the ridge, show numerous small solution features including open karst pipes with diameters of up to 50cm (Plate 4-4). The sinkhole is clearly free draining and appears to have a high hydraulic conductivity. Sinkhole #2 on the other hand does not have visible solution features or even limestone outcrops. The depression is completely covered with soil and vegetation, has gentle sloping edges and a maximum depth of approximately 3m. Although rainfall did occur at the time of the fieldwork, no standing water or even wet muddy areas were observed in the depression, indicating good internal drainage. While Sinkhole #2 is reported to overflow on occasions into sinkhole #1, the surface drainage channel linking the two sinkholes is barely traceable. This indicates that the overflow is not a normal event and confirms that depression is a sinkhole and not merely a retention pond.

Figure 4-20 shows the existing drainage in and around the property. The runoff coming out of the hills to the Northwest and Northeast of the development are channelized respectively by the Kitson Town main road and the unpaved Dovecot Cemetery road. The runoff channel along the unpaved Dovecot Cemetery road, the main drainage channel in the area, is reported to have caused flooding of the settlements along the road. The property however does not contribute runoff of any significance to this drainage channel. There are no significant drainage channels traversing the property and ,while there are several shallow closed depression on the property, there is no apparent problem with stagnant water either. The runoff on the property is dominated by sheet flow and a high infiltration rate and is controlled by the low ridge near the south eastern boundary of the property and the two sinkholes. The low ridge forms a watershed divide which directs the runoff to the sinkholes and the sinkholes collect most if not all of runoff coming of the property to the northwest of the ridge, which is about 80 % of the property. The remainder of the property to the southeast of the ridge line drains to the southeast. Since there are no significant stream channels on the south-eastern side of the ridge, it is reasonable to assume that the drainage consists mainly of overland flow and that most of the runoff is absorbed in the shallow depression to the south east of the ridge.

Finally it should be mentioned that in addition to the natural occurring depressions there are seven (7) pits on the property which were excavated with backhoe or bulldozer to a depth of 2 to 3m. They are located near the intersection of the two unpaved road that cross the property and show up in the slope map as areas of high relief (Figure 4-19). These pits are expected to be removed by the landscape design and will further be discussed in the section on Geology and Soils.

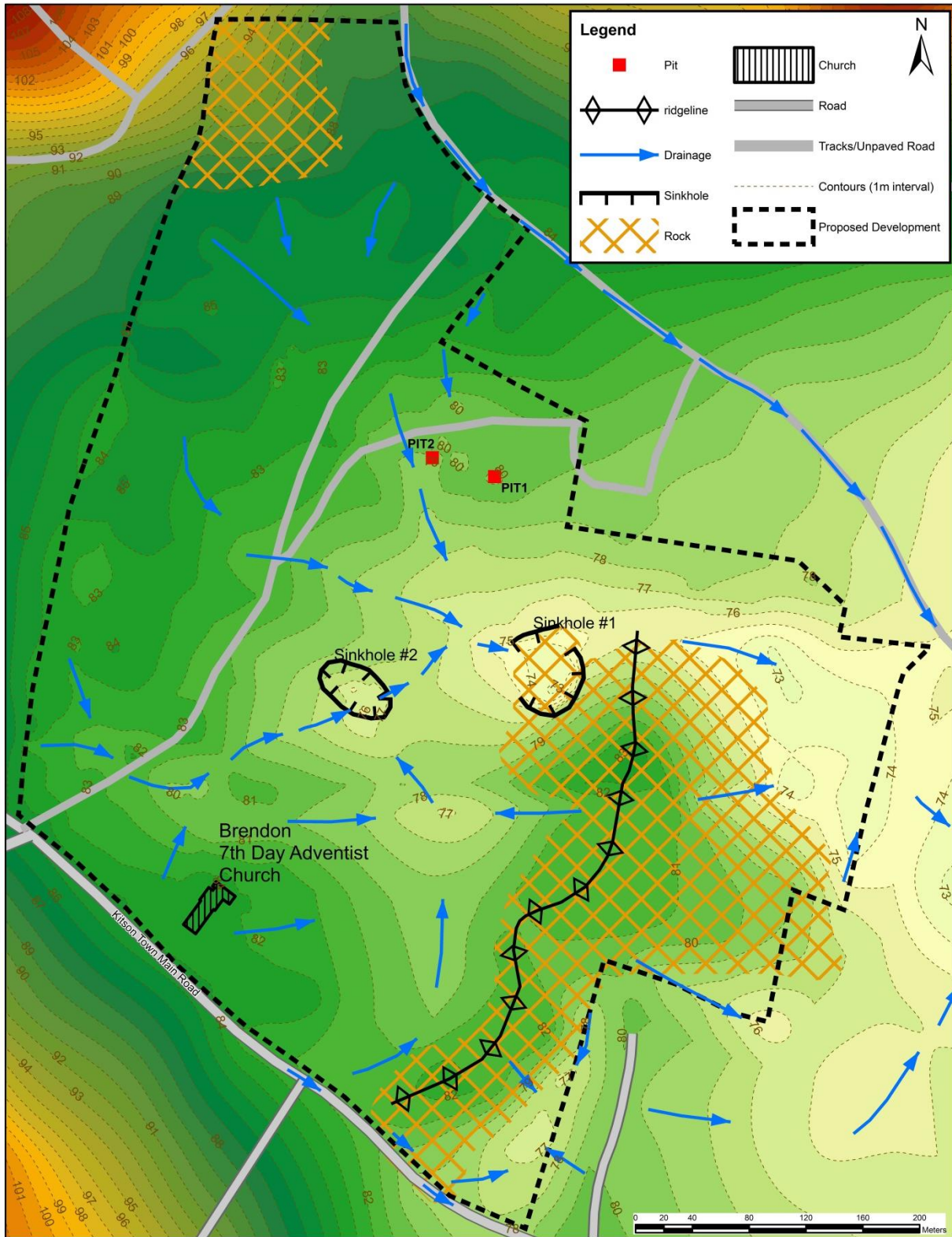

Figure 4-20 Drainage and topographic features of the property



Plate 4-4 Edge of Sinkhole #1 (a) and Karst Pipe (b)

#### 4.1.5 Geology and Soils

The area has been mapped by the Mines and Geology Division to consist of the Walderston-Brown's Town Formation (Owb), a member of the White Limestone group (Figure 4-21). Limestone bedrock is exposed in the low ridge on the south-eastern border of the property and in the foot of the escarpment at the northern end of the property. Except for Sinkhole #1, all outcrops are small and are partially covered by a thin soil layer. The outcrop in Sinkhole #1 consists of hard, white sparite and microsparite. The rocks are affected by karst processes including brecciation and partially recrystallization. Part of the outcrop shows some bedding. The bedding has a spacing of 10 to 40 cm and dips 15 degrees to the SSE. The unconfined compressive strength of the limestone at the surface is estimated to range from 55 to 103MPa (8,000 to 15,000psi). Although the typical Walderston Formation deposits consist generally of soft chalky limestone, the hardness of the rocks both within the exposure site of sinkhole # 1 and in the many small surface exposures on the ridge is not just caused by case hardening but appears to be a consistent feature of the deposit throughout the exposed limestone ridge.

An estimated 75% of the property is covered with the St. Ann Clay Loam. It is the same well drained, deep red "Terra Rossa" soil which can be found in much of the limestone uplands. The St. Ann Clay Loam is characterized by a very thin organic top layer and a uniform texture, structure and colour. It is considered a very poor soil and is mainly used as pasture, for mixed sustenance cultivation by small farmers and to some extent for citrus. The seven (7) pits near the intersection of the two unpaved roads on the property show that the St. Ann Clay loam soil cover is very thick here. All seven (7) pits were dug to a depth of 2.5 to 3 meter without a sign of the underlying limestone bedrock. In an attempt to determine the depth to the bedrock, two of the existing pits were further excavated with a backhoe to a depth of 5m but the bedrock was not reached. The same uniform red clayey silt beginning from just below 5cm thick organic layer at the surface was found all the way to the bottom of the excavation



without any indication that the bedrock was nearby (Plate 4-5). The location of these two pits is shown in Figure 4-20.



Plate 4-5 Excavation and profile of Pit #2

The low ridge in the south-eastern section of the property is covered with the Bonny Gate Stony Loam which is often only a few centimetres thick. This very shallow black soil is very susceptible to erosion and is often missing, exposing the underlying limestone bedrock in many places. Because of its poor water retention capability this soil type carries mainly xeric vegetation.

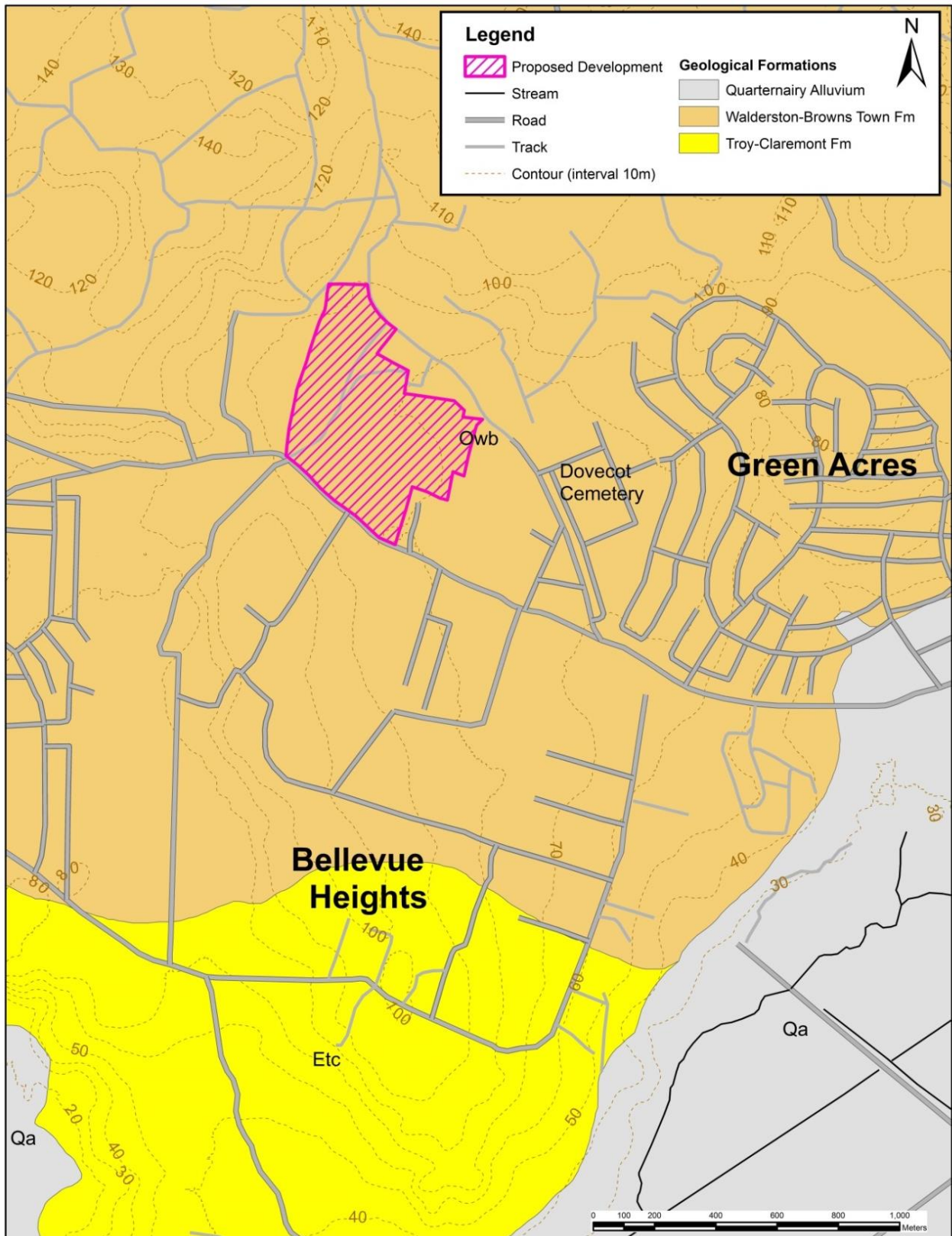

Figure 4-21 Geology Map (based on 1:50,000 Geological Map Series Metric Edition, MGD)



## 4.1.6 Surface Drainage

### 4.1.6.1 Existing Drainage Features

The site lies in an area that is can be described as a storm water catchment area. It is also an area where groundwater recharge occurs through sinkhole on the property as well as near to the property.

Site visits indicate that storm water flows from the wider catchment area and enters the site at various locations; these include various sections along the length of the western boundary and the south-western corner of the boundary along St. Johns Road.

Storm water flows in the wider are and the site are generally directed by the terrain and storm drains to sinkholes. Two sinkholes were identified onsite whereas another two (sinkhole 3&4) were identified offsite and within 500m of the project boundaries. The storm water flows from the hills to the west of the site cross the western site boundary and unto the site where they are intercepted by the sinkholes (1&2). Flows further north of the site generally travel along the "Dovecot Cemetery Road" via an earthen swale and a concrete drain before discharging to sinkhole 4. Residents living in the are indicated that the area surrounding sinkhole 4 is prone to flooding whenever the sinkhole is overwhelmed of gets blocked.

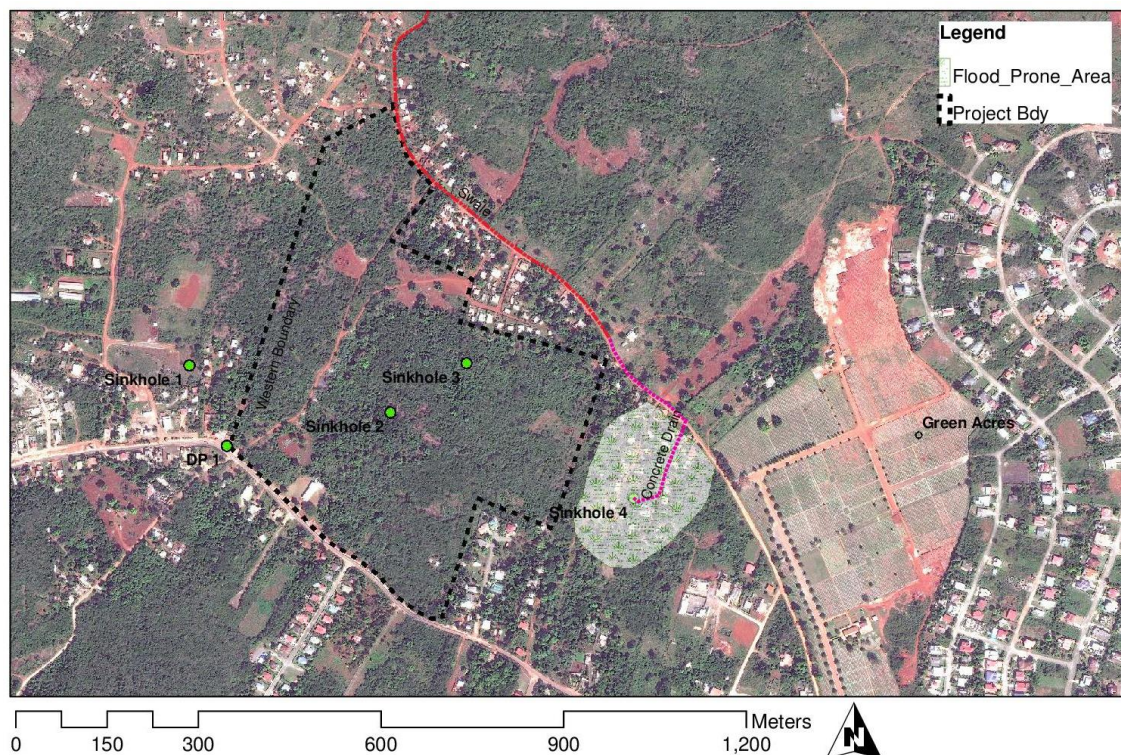

Figure 4-22. Existing drainage features contiguous to the site

#### 4.1.6.2 Soils and Drainage

The development is superimposed on the ministry agriculture soils map of the area. The soils in the area surrounding the site are St. Ann clay loam. This soil type is described as having rapid internal draining by the Soils and Land-use map of Jamaica by (Vernon & Jones, 1958).

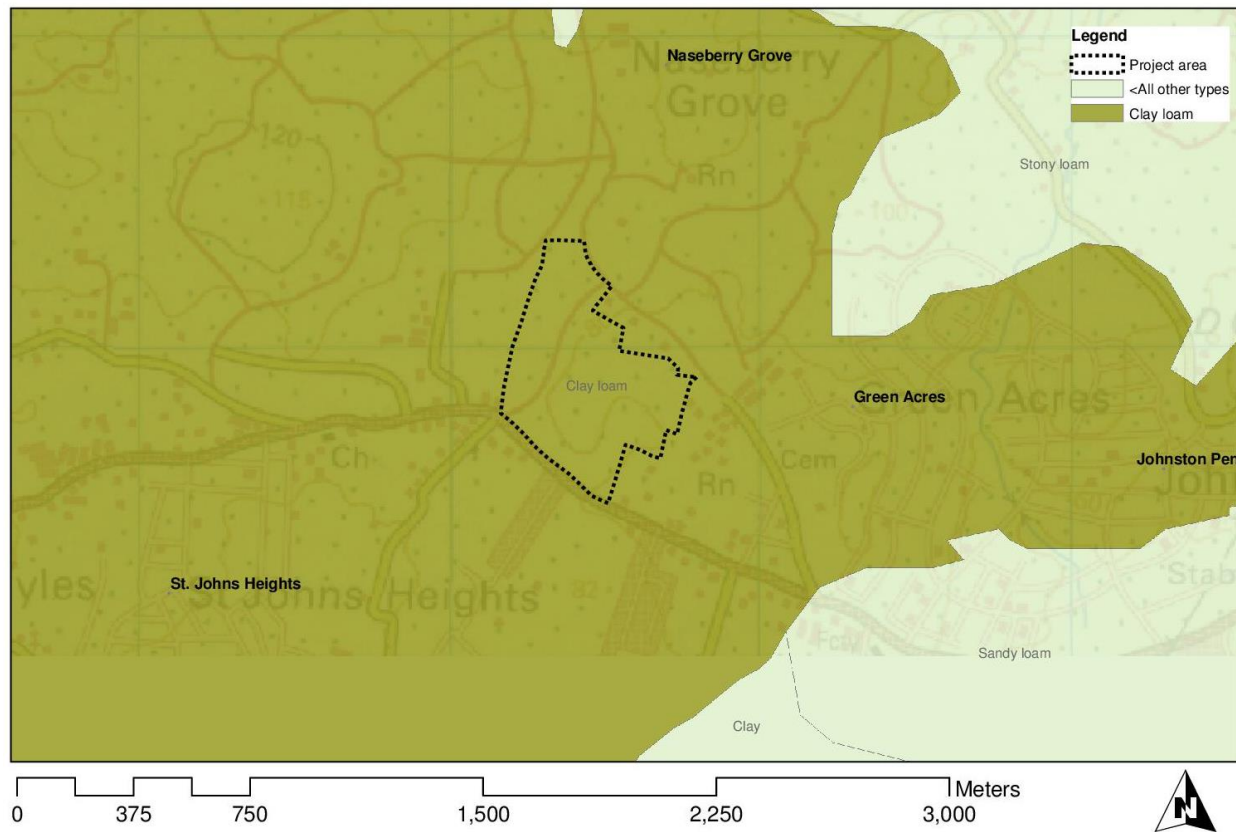

Figure 4-23. Layout of the development superimposed on the Ministry of Agriculture Soils map of Jamaica.

Percolation tests were conducted on site at two locations to measure the drainage through the soil. This is especially important for drainage and for gauging how easily the groundwater can be affected by possible contaminants onsite.

The results indicated the soils on the property have a medium to low percolation rate; locations 1 and 2 had rates of 58 to 75 minutes per centimetre respectively. This means whenever the boreholes are blocked water will stand for a few hours to a day before seeping into the soil. As far as contaminant transport is concerned however, this could be considered rapid when compared to other similar locations that have percolation rates as low as 100 to 300 in some sections.

Table 4-5 Percolation rates obtained from two test pits on site

TEST PIT	DEPTH		PERCOLATION RATE	
	Ft	m	MIN/INCH	MIN/CM
1	4.1	1.25	22	55
2	3.6	1.10	32	74

#### 4.1.6.3 Runoff

##### Method

Runoff total and peak runoff from the site checked using the SCS method. This is an empirical model for rainfall runoffs which is based on the potential for the soil to absorb a certain amount of moisture. On the basis of field observations, this potential storage  $S$  (millimetres or inches) was related to a 'curve number'  $CN$  which is a characteristic of the soil type, land use and the initial degree of saturation known as the antecedent moisture condition. Hydrological modelling of the watersheds encompassed three main elements:

- Precipitation
- Rainfall abstraction model (Curve number method)
- Runoff model (Dimensionless unit hydrograph)

The SCS curve number method was used to determine the rainfall excess  $P_e$  using the following equation:

$$P_e = \frac{(P^2 - I_a^2)}{P - I_a} + S$$

Where,  $P$  = precipitation

$I_a$  = initial abstraction

$S$  = Potential retention which is a measure of the retention capacity of the soil.

The Maximum Potential retention,  $S$ , and the watershed characteristics are related through the Curve number  $CN$ .

$$S = \frac{25400 - (254 \times CN)}{CN}$$

Curve Numbers have been tabulated by the NRCS on the basis of soils group, soil cover or land use, and antecedent moisture conditions (initial degree of saturation).



The peak runoffs are generally calculated using the type III rainfall distribution for catchments in Jamaica. The primary inputs into the model are as follows:

- Drainage area size (A) in square metres;
- Time of concentration (Tc) in hours;
- Weighted runoff curve number (RCN);
- Rainfall distribution (see Figure 4-24);
- Total design rainfall (P) in inches (millimetres).

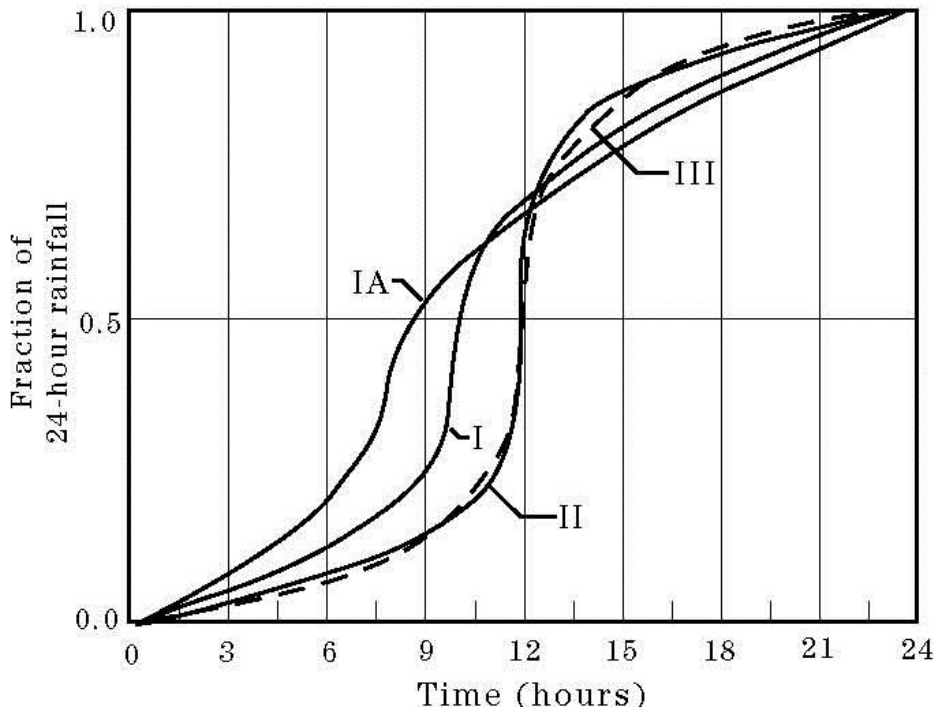

Figure 4-24 SCS 24-hour Rainfall Distributions

**Results**

The estimated peak runoff from the existing site is estimated to be in the order of 2.25m<sup>3</sup>/s from the 2 yr event to 6.24m<sup>3</sup>/s for the 100 year event. Similarly, the overall runoff for a 24hr storm will vary from 14,568 cubic metres to 40,350 cubic metres per day for the 2 to 100 year return storm.

Table 4-6 Comparison of the peak runoff from the site for the existing and post development condition

Return Period (yr)	2	5	10	25	50	100
<b>Peak runoff (m3/s)</b>						
Existing	2.25	3.31	4.04	4.95	5.61	6.24

Table 4-7 Comparison of the total 24hr rainfall runoff from the site for the existing and post development condition

Return Period (yr)	2	5	10	25	50	100
Total Runoff (m <sup>3</sup> )						
Existing	14568	21280	25969	31869	36166	40350

#### 4.1.7 Hydrogeology

##### 4.1.7.1 Hydrostratigraphy and Groundwater Flow

Hydrostratigraphy essentially deals with subsurface formations and their water bearing properties. The Water Resources Authority (WRA) has developed a hydrostratigraphy map of Jamaica which identifies the different hydrostratigraphic units across the island. It also indicates the general subsurface flow directions of the groundwater through units defined as aquifers. See Figure 4-25 below which shows the defined units as well as the groundwater flow direction in aquifers across the island.

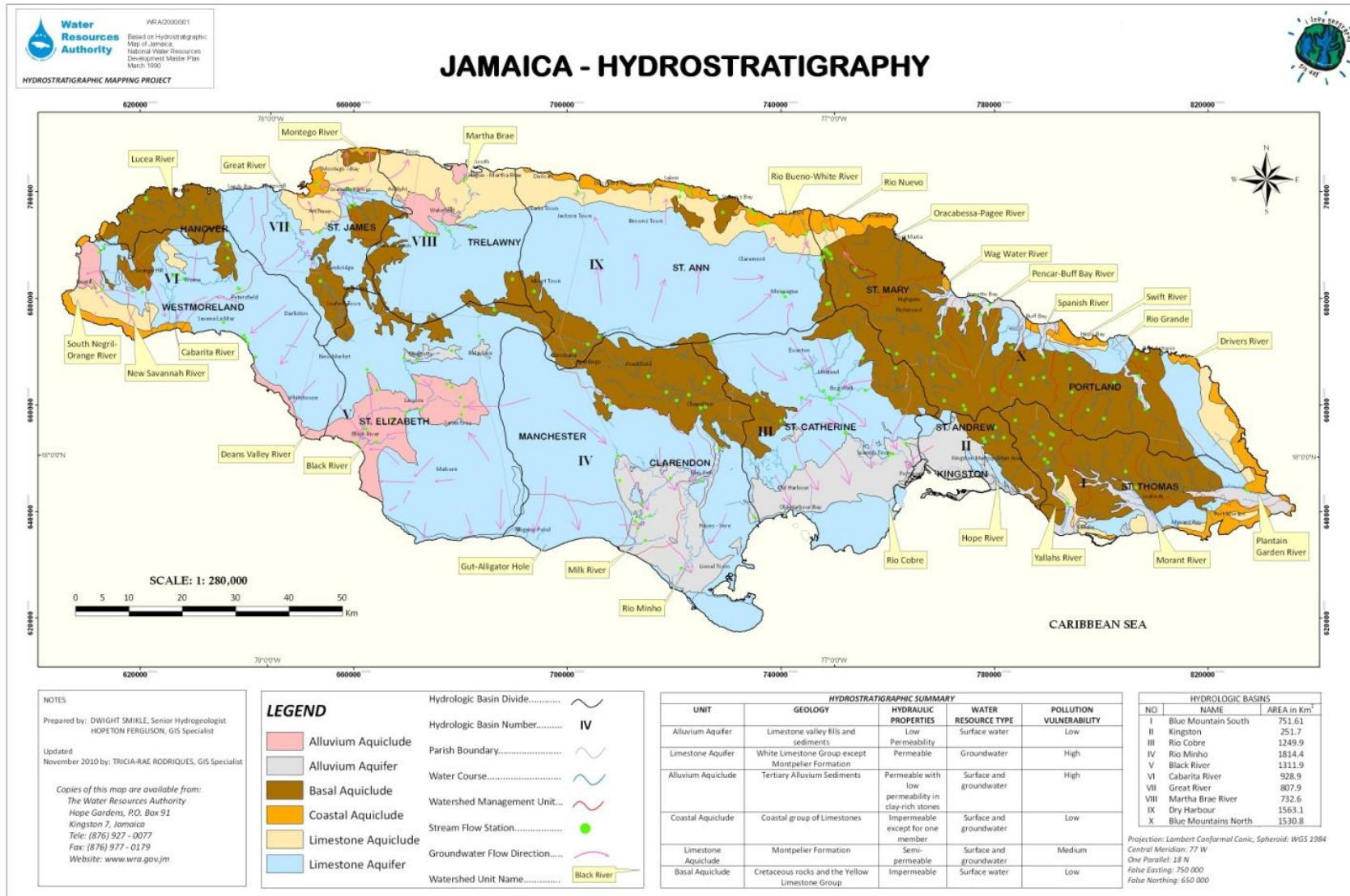

Figure 4-25. Hydrostratigraphy map of Jamaica, Source: WRA

The project site is located just above the southern foothills of the Paul Mountain range in central St. Catherine, just above the starting of the Liguanea plains which extends all the way to the southern coastline and to the Hellshire hills. There is a general flow of groundwater in this area is towards the south in this region, from the limestone aquifers in/below the mountains to the alluvium aquifers in the south.

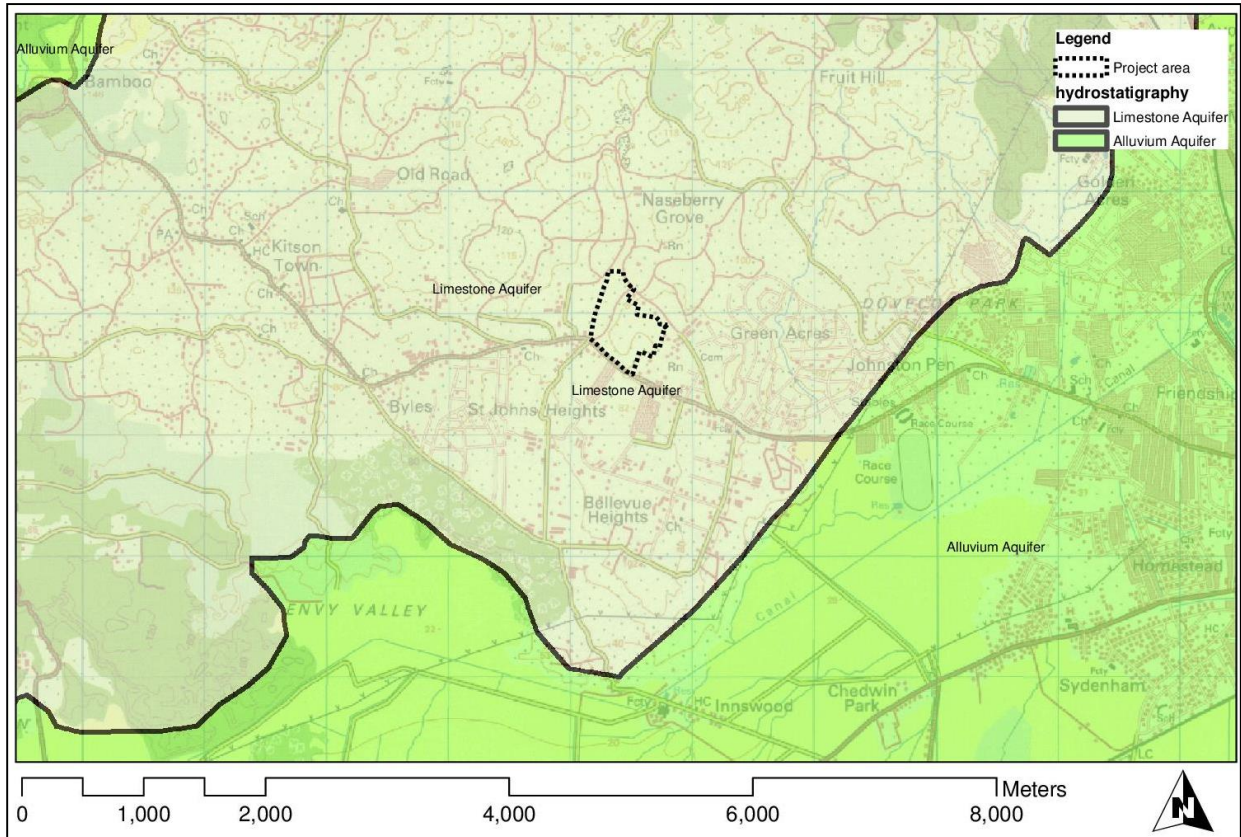

Figure 4-26 Location of the project area relative to the hydrostratigraphic units in St. Catherine

The levels of the aquifers were determined from well logs obtained from the WRA's online database. The logs indicate the water table is high in the limestone aquifers in the north and falls off sharply down to the plains in the south where the slopes are less steep. The water table below the project site is in the order of 45 to 50 metres above mean sea level (msl) whereas the site elevation is in the order of 80 metres above msl. See the plots of the water table levels in Figure 4-27 below. The groundwater flow in this location according to the WRA hydrostratigraphy map moves in a southerly direction. This is consistent with the natural gradient which is setup between the mountains in the north and the plains and sea in the south.



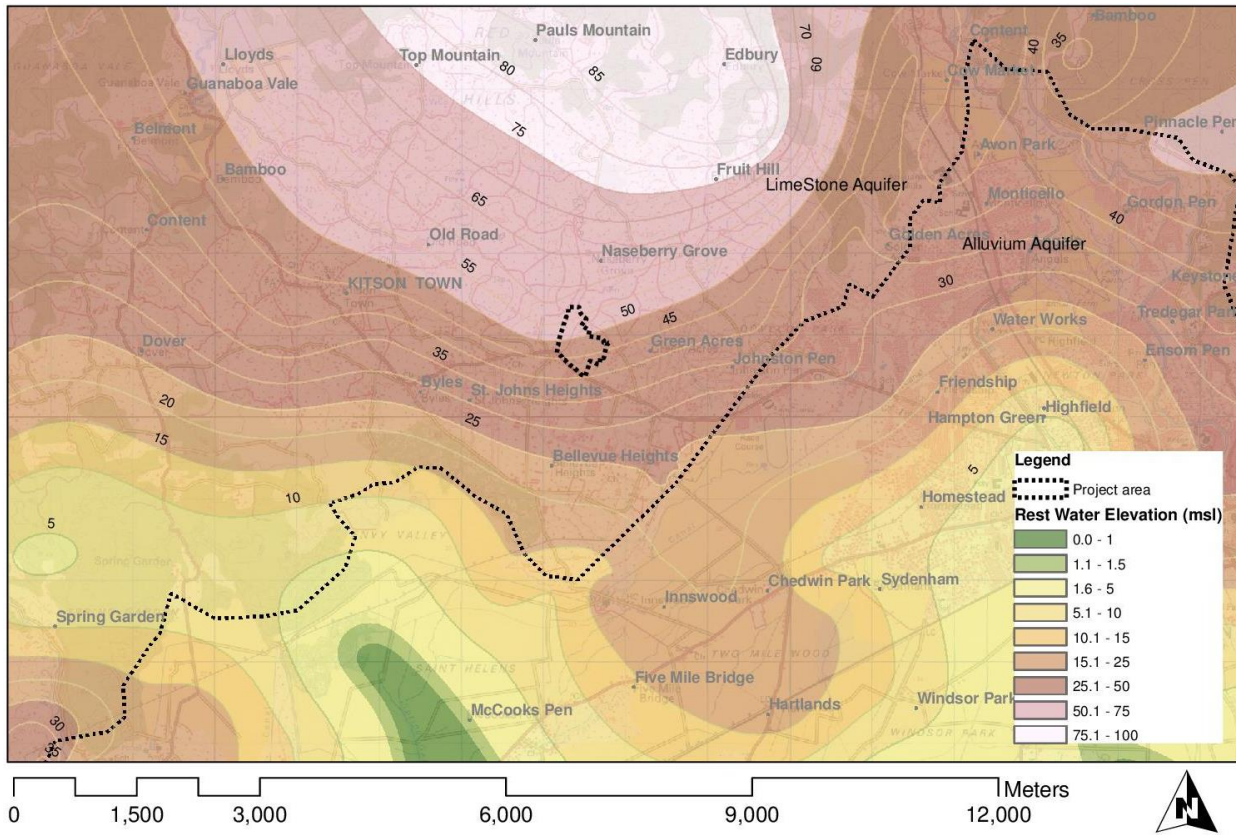

Figure 4-27 Elevations of the water table varying from high to low moving from the hills in the north to the plains on the south

## 4.1.8 Natural Hazards

### 4.1.8.1 Hurricanes

A tropical cyclone is a storm system which is characterized by a closed low-level wind circulation around a well-defined low pressure centre. At the low end of the scale are the Tropical Depressions (TD) with maximum sustained winds (MSW) of less than 62 km/h (38 mph or 34 knots) and the Tropical Storms (TS) with MSW ranging from 63 to 118 km/h (39 to 73 mph or 35 to 63 knots). Storms with maximum sustained wind in excess of 118km/h are classified as Hurricanes. The Saffir–Simpson hurricane scale groups Hurricanes into 5 classes from Category 1 (H1) to 5 (H5). Category 3, 4 and 5 hurricanes with Maximum Sustained Wind of at least 178km/h (111 mph or 96 knots) are considered major hurricanes.

The intensity and frequency of the tropical cyclones fluctuate from year to year with various global meteorological conditions, and appear to be influenced by phenomena such as El Nino/La Nina and sea surface temperatures. A 2008 study by Saunders, Mark A., and Adam S. concluded that local sea surface warming was responsible for an approximate 40% increase in North Atlantic hurricane activity between 1996 and 2005 relative to the 1950-2000 average but it did not identify whether or not warming induced by greenhouse gases played a roll.



Jamaica is located in the southern section of the Atlantic Hurricane belt. The hurricane season begins officially on the 1<sup>st</sup> of June and ends on the 30<sup>th</sup> of November. Figure 4-28, a compilation of the prevailing Hurricane tracks for the North Atlantic basin, illustrates that Jamaica is most likely to be affected by a hurricane in the month of August, September and October. Figure 4-29 shows the tracks of the eye of storms based on the IBTrACS data (International Best Track Archive for Climate Stewardship) of all the systems that have passed within 50 nautical miles or 92.6 km of the proposed development between 1842, the beginning of the record, and the end of 2012. Table 4-8 list in chronological order the storms, the intensity and maximum sustained winds of the storm near the proposed development. In total, forty-six (46) tropical cyclones passed between 1842 and 2012 within a 92.6km (50nm) radius of the proposed development. This includes 5 tropical depressions, of which 3 developed farther into hurricanes. On average one (1) tropical storm or greater occurred every 4.2 years and one (1) hurricane every 7.4 years. A major hurricane, (that is a category 3 hurricane or greater) passed every 28.5 year within a 92.6km (50nm) of the proposed development.

Statistically the largest number and most severe storms occur in the month of August closely followed by the months of September and October with a similar number but on average less intense storms (Figure 4-30).

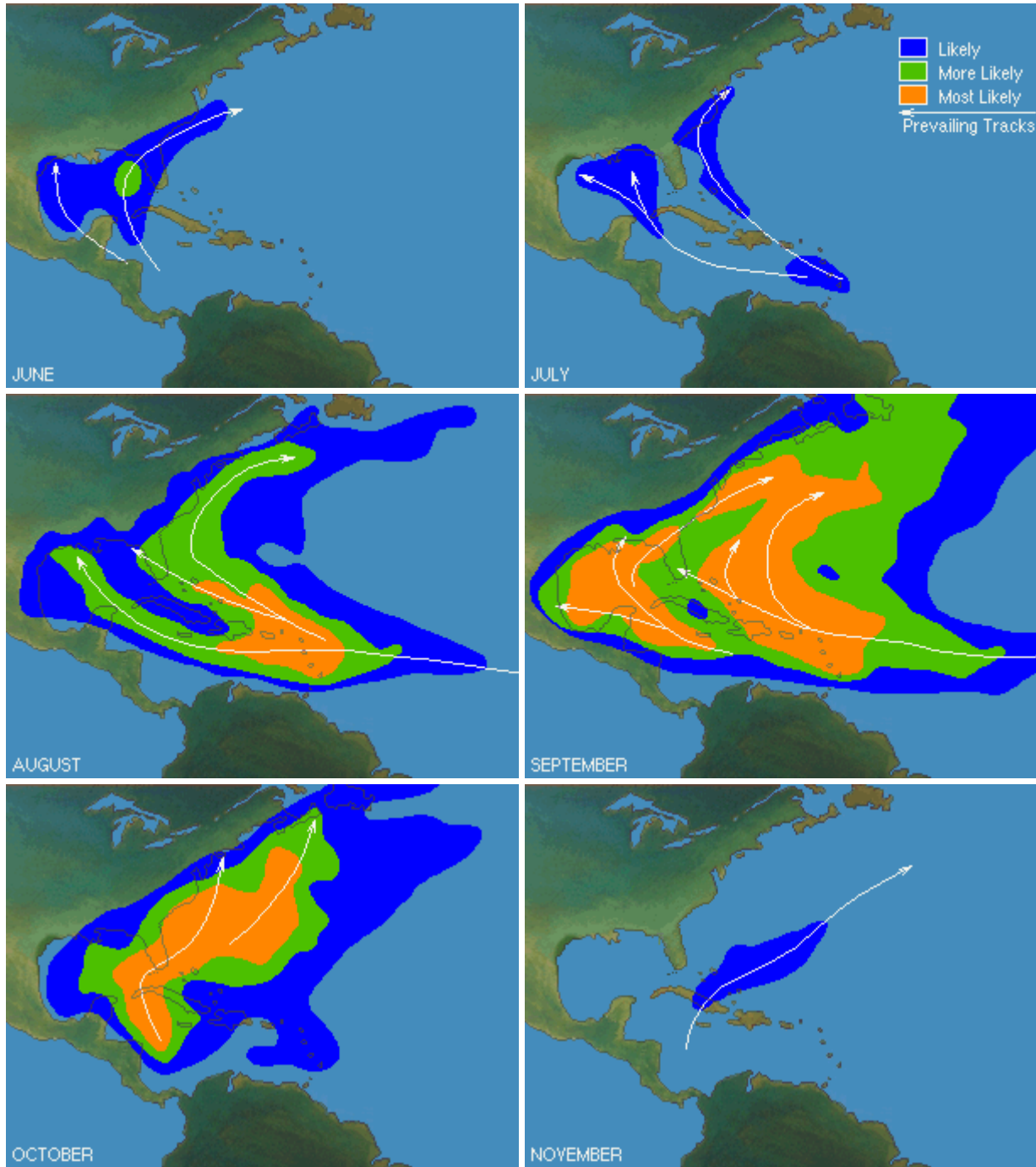

Source: NOAA ([www.nhc.noaa.gov](http://www.nhc.noaa.gov))

Figure 4-28 Prevailing hurricane tracks in the Atlantic Basin

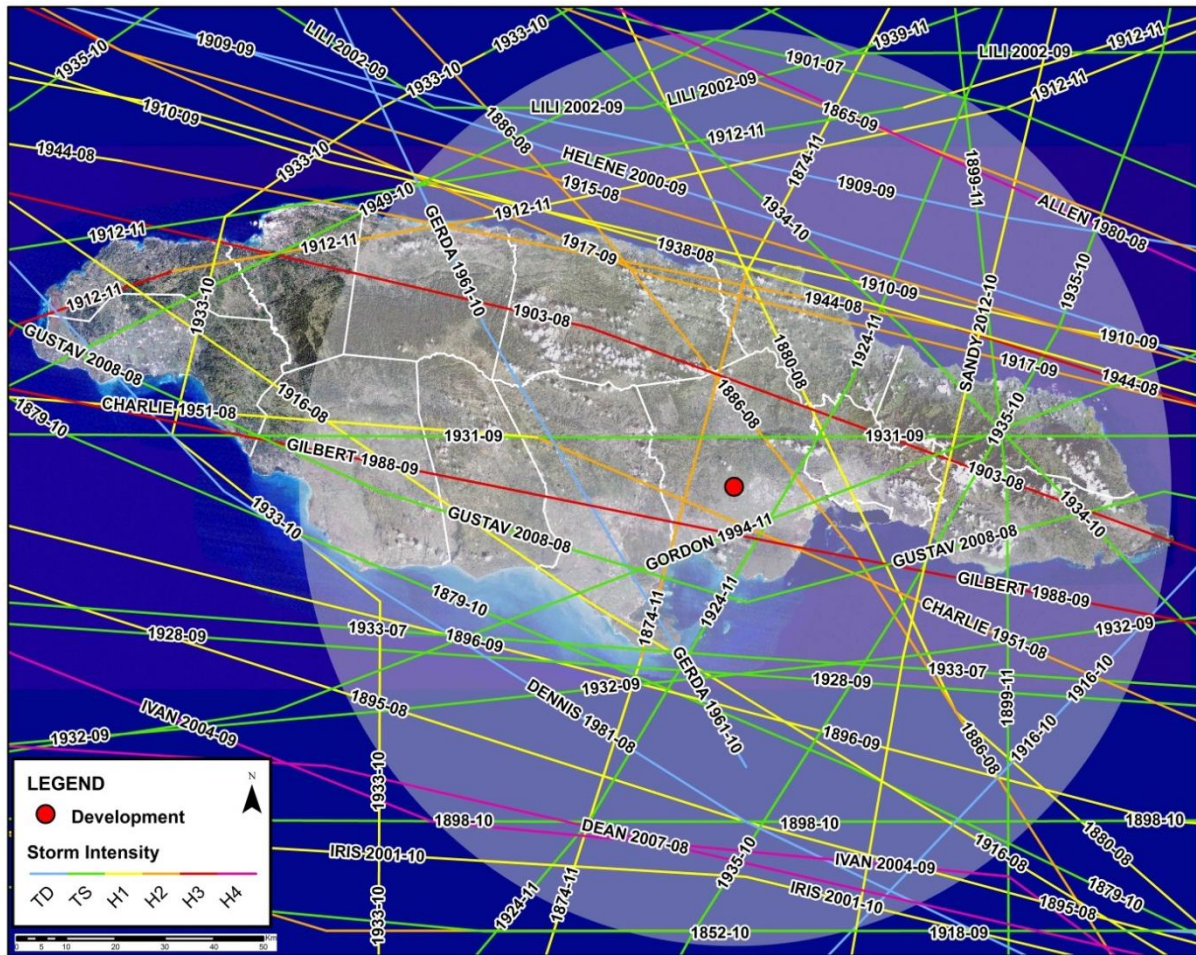

Source: IBTrACS v03r05

Figure 4-29 Tropical Cyclones from 1842 to 2012 within 50nm of the proposed development. (Track label: name of the storm, year - month)

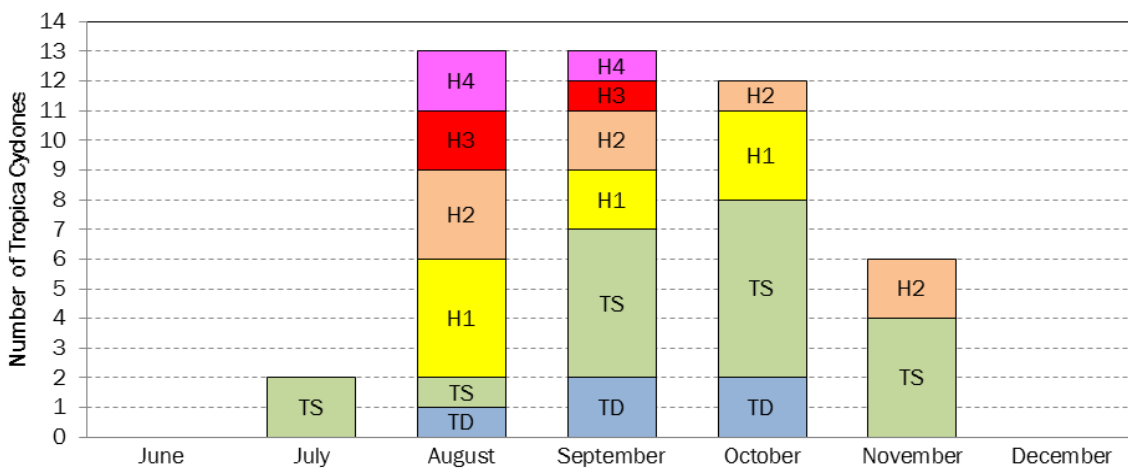

Source: IBTrACS v03r05

Figure 4-30 Tropical Cyclones per month within a 50nm (92.6km) radius

**Table 4-8 Tropical Cyclones (1842 - 2012) within 50nm (92.6km) radius of the proposed development**

Source: IBTrACS v03r05

Name	Year	Month	Class	MSW
UNNAMED	1852	10	H2	90
UNNAMED	1865	9	H2	90
UNNAMED	1874	11	H2	90
UNNAMED	1879	10	TS	50
UNNAMED	1880	8	H1	80
UNNAMED	1886	8	H2	95
UNNAMED	1895	8	H1	80
UNNAMED	1896	9	H1	70
UNNAMED	1898	10	TS	50
UNNAMED	1899	11	TS	55
UNNAMED	1901	7	TS	60
UNNAMED	1903	8	H3	105
UNNAMED	1909	9	TD	30
UNNAMED	1910	9	H1	70
UNNAMED	1912	11	H2	85
UNNAMED	1915	8	H2	95
UNNAMED	1916	8	H1	70
UNNAMED	1916	10	TD	25
UNNAMED	1917	9	H2	90
UNNAMED	1918	9	TS	35
UNNAMED	1924	11	TS	40
UNNAMED	1928	9	TS	35
UNNAMED	1931	9	TS	60
UNNAMED	1932	9	TS	45
UNNAMED	1933	7	TS	35
UNNAMED	1933	10	H1	75
UNNAMED	1934	10	TS	40
UNNAMED	1935	10	TS	50
UNNAMED	1935	10	TS	55
UNNAMED	1938	8	H1	65
UNNAMED	1939	11	TS	55
UNNAMED	1944	8	H3	105
UNNAMED	1949	10	TS	35
CHARLIE	1951	8	H2	95
GERDA	1961	10	TD	30
ALLEN	1980	8	H4	115
DENNIS	1981	8	TD	15

Name	Year	Month	Class	MSW
GILBERT	1988	9	H3	110
GORDON	1994	11	TS	35
HELENE	2000	9	TD	30
IRIS	2001	10	H1	75
LILI	2002	9	TS	45
IVAN	2004	9	H4	135
DEAN	2007	8	H4	125
GUSTAV	2008	8	TS	60
SANDY	2012	10	H1	75



#### 4.1.8.2 Earthquakes

Jamaica is located on the border between Gonave micro-plate and Caribbean tectonic plate and is therefore subjected to significant seismic activity and earthquakes. Figure 4-31 shows the location of the epicentres and the magnitude of recent earthquake events in the Jamaican region between 1977 and 2014 in relation to the proposed development. The proposed development is located on the south eastern edge of the Clarendon block, west of the Wagwater Fault Zone. While the epicentre density and magnitudes in Figure 4-31 indicates that this area is a less seismically active than the Plantain Garden fault area north of Kingston, the energy released by a major earthquake on the Plantain Garden fault, the Wagwater Fault zone, or any of the other faults has the potential to cause major damage at the proposed development area. For example the 7.5  $M_w$  earthquake of 1692 which destroyed Port Royal and which had an it's epicentre on the Plantain Garden east of Kingston demolished almost all of the houses in Spanish Town, a mere 7 km to the east southeast of the proposed development site.

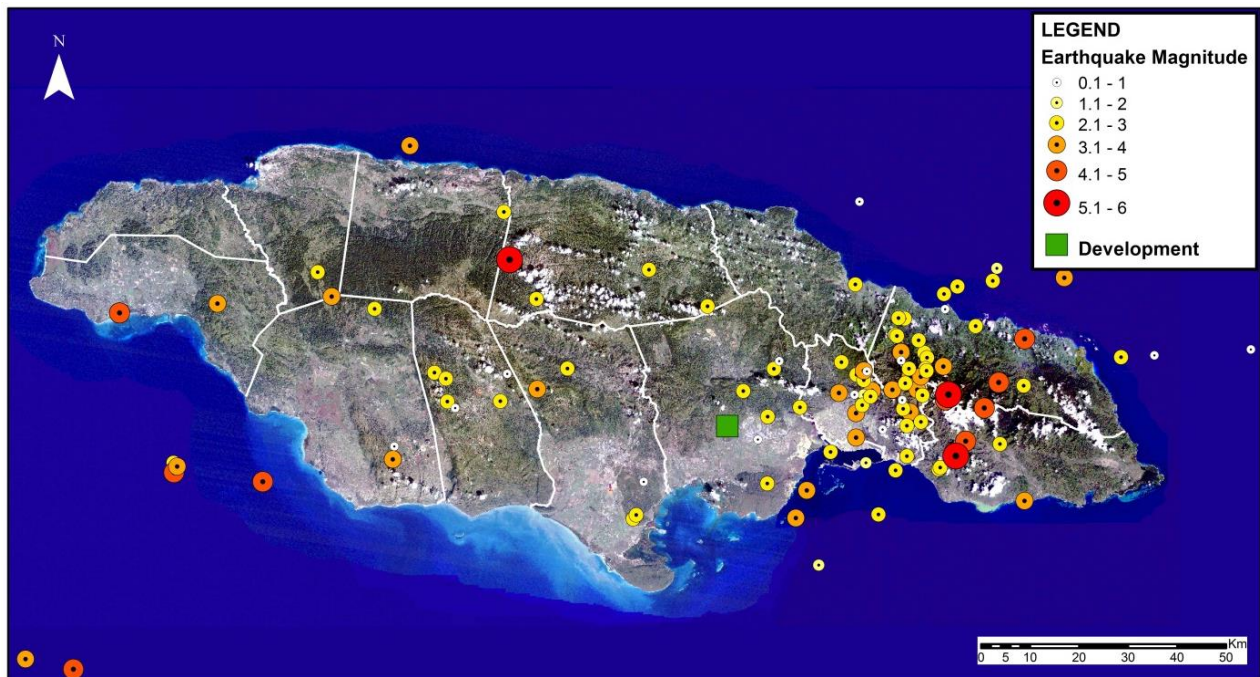

Source: Earthquake Archive @ <http://earthquake.usgs.gov/>

Figure 4-31 Earthquakes in Jamaica from 1977 to 2014

The Probabilistic Seismic Hazard Assessment of Jamaica by W. Salazar, L. Brown and G. Mannette provide design estimates for Peak Ground Acceleration (PGA) for the Return Period of 475 years and Spectral Acceleration at a period of 0.2s and 1s for the Return Period of 2475 and 4975 years. Peak ground acceleration (PGA) is the maximum horizontally acceleration (or rate of change of speed) that the ground is subjected to by an earthquake. The preferred parameter in most modern building code and the one used by the International Building Code 2012 is the Response Spectral Acceleration (SA). Spectral Acceleration is the maximum horizontally acceleration that an object (like building) will



experience by a seismic wave of a specific period. The oscillator period is chosen to match the natural period of the structure; the short period 0.2 sec corresponds with short buildings that are a few floors tall and the long period of 1.0sec with tall buildings of more than 7 floors. For a cemetery development only the short period (0.2s) Spectral Acceleration values are of course relevant. The Peak Ground Acceleration and Spectral Accelerations for the project area extracted from the seismic hazard maps published in W. Salazar, L. Brown and G. Mannette (2013) are summarized in the table below (Table 4-9).

Table 4-9 PGA, 0.2s SA and 1.0s SA for the Proposed Development Area

Parameter	Return Period in Years		
	475	2475	4975
PGA	0.191-0.227g	-	-
0.2s SA	-	0.868-1.016 g	1.204-1.292g
1.0s SA	-	0.280-0.255 g	0.378-0.346g

#### 4.1.9 Water Quality

Water quality testing was not feasible as there are no surface water bodies within 500 m of the site. The 500 m guideline is intended to provide protection against worst-case scenarios in which a cemetery is sited upstream of a production well and on geological formation that functions as an aquifer. Testing water quality in the nearest point in the irrigation canal south of the site is unlikely to yield information that would allow for better environmental management as it is too far away (>2.3km), and affected by many sources. The proposed expansion area is situated within a residential area and west of Dovecot Cemetery.

Twelve (12) wells are located within 2km of the proposed development. The closest wells are the Naseberry Grove wells (>250m North West), Bellevue Co-op well (~1.5km South), Bellevue well (~1.5km east) and Green Acres well (~1.5km east). However, the area is situated on a limestone aquifer which is permeable and has high pollution vulnerability. The groundwater flow direction is southerly and thus a monitoring well should be placed at the southern end of the site. The well locations are listed in Table 4-10 and shown in Figure 4-32.

A comparison of the water quality records for the Green Acres well with the WHO 2012 guidelines indicated the nitrates are higher than required for safe long term consumption (Table 4-11).

Historical well data has been provided below by the WRA for the Green Acres well.

Table 4-10 Location of wells within 2km radius of the proposed development

Well	Northing (m)	Easting (m)
Green Acres	650505.631	749170.443
Naseberry Grove	651,607.634	747,135.438
Naseberry Grove #1	651,538.634	747,399.438
Naseberry Grove #2	651,328.742	747,558.716

<b>Well</b>	<b>Northing (m)</b>	<b>Easting (m)</b>
Bellevue Co-op	649,640.187	747,346.171
Mango Walk 1	649,740.629	748,831.442
Mango Walk 2	649,459.628	748,641.442
Mango Walk 3	649,496.628	748,709.442
Mango Walk 4	649,466.628	748,618.441
Mango Walk 5	649,596.629	748,807.442
Bellevue	650,112.510	749,282.696
Frazers Content	650,950.884	750,014.797

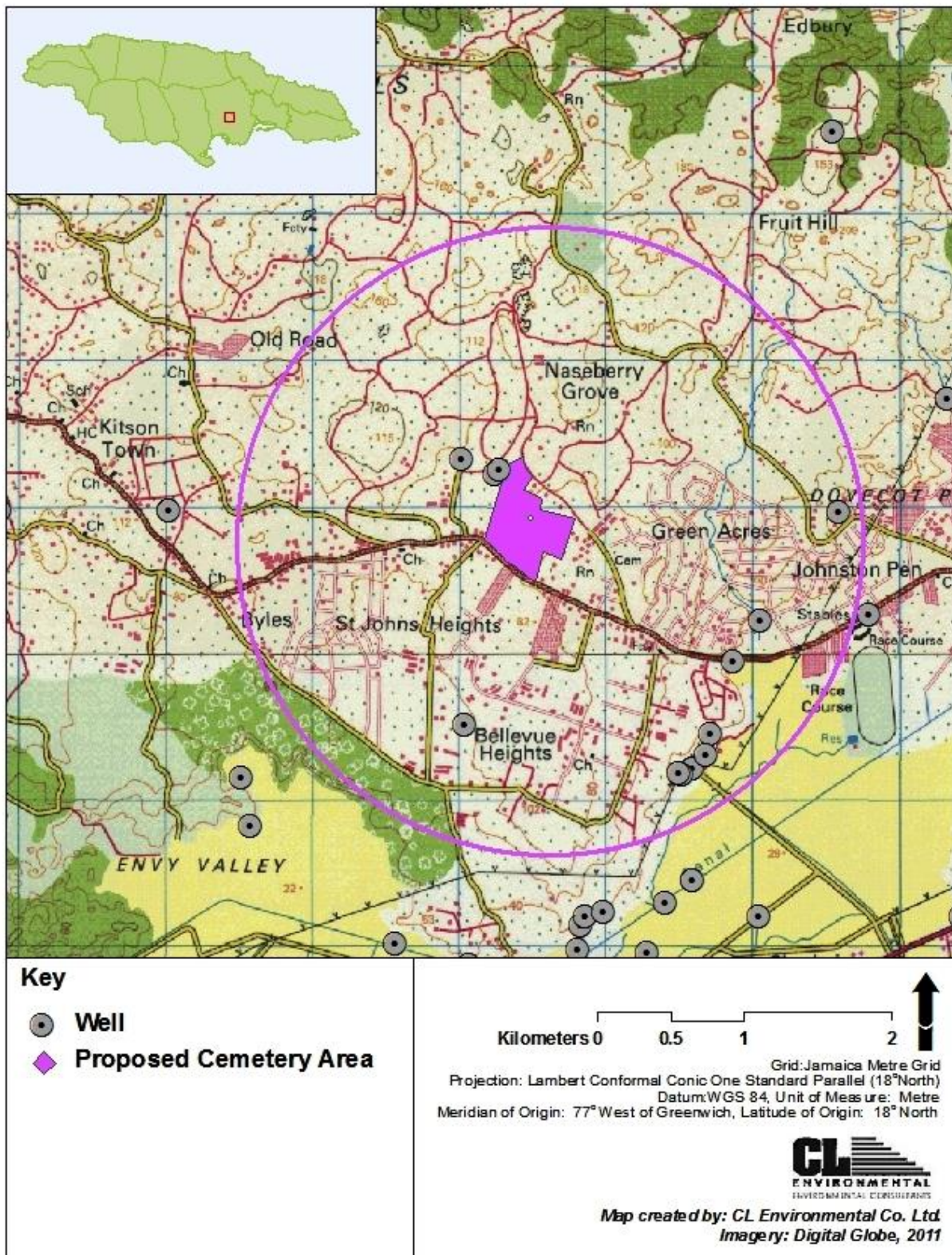

Figure 4-32 The location of the proposed area with 2km buffer and nearest wells.

**Table 4-11 Historical water quality data for Green Acres well**

Source: WRA

Parameter	Green Acres Well Water Quality Records						WHO Drinking water Standards
	1990	1992	1993	1994	1998	2003	
Colour (Hazen)	0	0	0	-	0	-	
Turbidity (NTU)	0.43	0.08	0.95	0.03	0.17	0.1	-
Conductivity (uS/cm)	522	542	580	545.7	512	611	
pH	7.4	7.4	7.6	7.4	7.3	7.3	6.5 to 8.5
TDS (mg/l)	325.3	332.8	328	337	-	375	500
TSS (mg/l)	326	333	328	337	305	-	
Tot. Alkalinity (mg/l)	281	280	260	258	270	266	-
Tot. Hardness (mg/l)	290	293	273	278	278	292	
Nitrites (mg/l)	0	0	0	0.001	0.001	-	1
Nitrates (mg/l)	18.2	14.8	21	14.4	16.1	20.6	10
COD	1	0.3	0.7	1.22	2.3	1.3	
Free CO2	-	-	-	-	-	-	
Fluoride (mg/l)	0.17	0.03	0.09	0.08	-	0.28	2
Silica (mg/l)	4.9	-	2.8	4	-	6.7	
Manganese (mg/l)	0	0	0	-	0	0	0.05
Iron (mg/l)	0	0	-	0	0	0	0.3
Aluminum (mg/l)	0	0.007	-	-	-	0	
Calcium (mg/l)	98	94	99	94	95	96.3	200
Magnesium (mg/l)	10.9	14.4	6.3	10.5	9.9	12.5	150
Sodium (mg/l)	8.3	9.5	7	8.4	10.8	9.7	200
Potassium (mg/l)	1.1	0.8	1.6	0.7	1.4	0.7	-
Sulphate (mg/l)	4	1.8	0	0	21	0	250
Chloride (mg/l)	3.5	16	18	15	13.5	18	250
Chromium (mg/l)	-	-	-	-	-	-	0.05
Scandium (mg/l)	-	-	-	-	-	-	
Strontium (mg/l)	-	-	-	-	-	-	
Boron (mg/l)	-	-	-	-	-	-	
Sulphide (mg/l)	-	-	-	-	-	-	
Ammonia (mg/l)	-	-	-	-	-	-	
Bicarbonate (mg/l)	-	-	-	-	-	-	

## 4.2 BIOLOGICAL

### 4.2.1 Flora

#### 4.2.1.1 Site Description

The vegetation of the site is highly disturbed; dominated by shrubs and saplings below four meters in height. The canopy structure may be described as short and open (only a few canopies touching), with few mature trees greater than five meters in height. The upper canopy (trees > 4 meters) is dominated by *Chrysophyllum oliviforme* (Wild Star-apple), *Haematoxylum campechianum* (Logwood) and fruit trees such as *Mangifera sp* and *Manilkara zapota*, that have been spared removal over time. The lower canopy is dominated by *Haematoxylum campechianum*, *Chrysophyllum oliviforme*, and species of *Acacia*, *Casearia* and *Eugenia*. The understory where present is thick and closed, and dominated by vines, shrubs, grass (e.g. *Lasiacis divaricta*) and seedlings of *Haematoxylum campechianum* and *Chrysophyllum oliviforme*. There is a disproportionately large quantity of saplings and seedlings, compared to a small number of trees represented in the canopy.

#### 4.2.1.2 Methodology

##### Field Procedure

---

The field sampling was done on a 71 acre property that is the proposed expansion of operation of the Dovecot Memorial Parks. The sampling was conducted over four weekends in May 2014. A 430 m belt transect set to a bearing of 164 degrees was constructed using a measuring tape and a compass to run a transect line. Every ten (10) meters along the transect line 10m X 10m plots were established on alternating sides of the transect line using polytwine and compass.





Figure 4-33 Survey Site for proposed expansion of Dovecot Memorial Park, indicated in red. Transect line indicated in green running north to south across the designated area.

Plants with stems greater than 10cm DBH were classified as trees; saplings were plants less than 10 cm DBH and greater than 1.3 m in height; and seedlings were plants less than 1.3 m in height. Within each plot the DBH (using DBH tape) and height (clinometer – Suunto PM-5/360 PC) of all trees were measured and recorded. The height of saplings and the number of seedlings within each box were also recorded. The composition of the shrub community was identified and the percentage cover (for all shrubs together) within the 10m X 10m plot was estimated and recorded. The shrub layer for the purpose of the vegetation profile and belt transect consisted of true shrubs, vines and grasses. The data collected from the plot was used to calculate density of the entire sample area as well as density per species, diversity and basal area. Samples of all the plants were collected and labelled for future identification.

The vegetation profile was created by identifying all plants that touched, hung above or were below the transect line. The percentage cover for each plant was recorded by estimating the percentage of each 10m segment of transect line that was covered by that plant; the position along the transect line was also recorded for each plant. All shrubs and vines were grouped together. This information was then displayed using Microsoft Excel to give an overview of the community structure.

#### **Plant Identification Procedure**

---

Plants were identified with the use of Adam's (1972) Flowering Plants of Jamaica in conjunction with preserved reference specimens of the herbarium. The plants were identified to the species level in most cases. For some of the plants identification was only to the more general genus or family level. A detailed species list of all plants identified within the plots and vegetation profile was created; this was supplemented using four 'walk through' throughout the study area, going in different directions each time. Species were categorized by determining if they were rare, endemic or endangered.

#### **4.2.1.3 Results**

##### **Density**

---

Density was calculated for all tree species for the area sampled; the number of individual included mature trees, saplings and seedlings. From the graph in Figure 4-34, which shows the number of stem/hectare of the twelve most densely represented species, *Haematoxylum campechianum*, *Chrysophyllum oliviforme*, *Eugenia sp.*, *Acacia sp.*, *Polygala jamaicensis*, *Allophylus jamaicensis* and *Leucaena leucocephala* had the highest density of all species recorded; this was due in part to the high abundance of seedlings found within each plot (Figure 4-35).

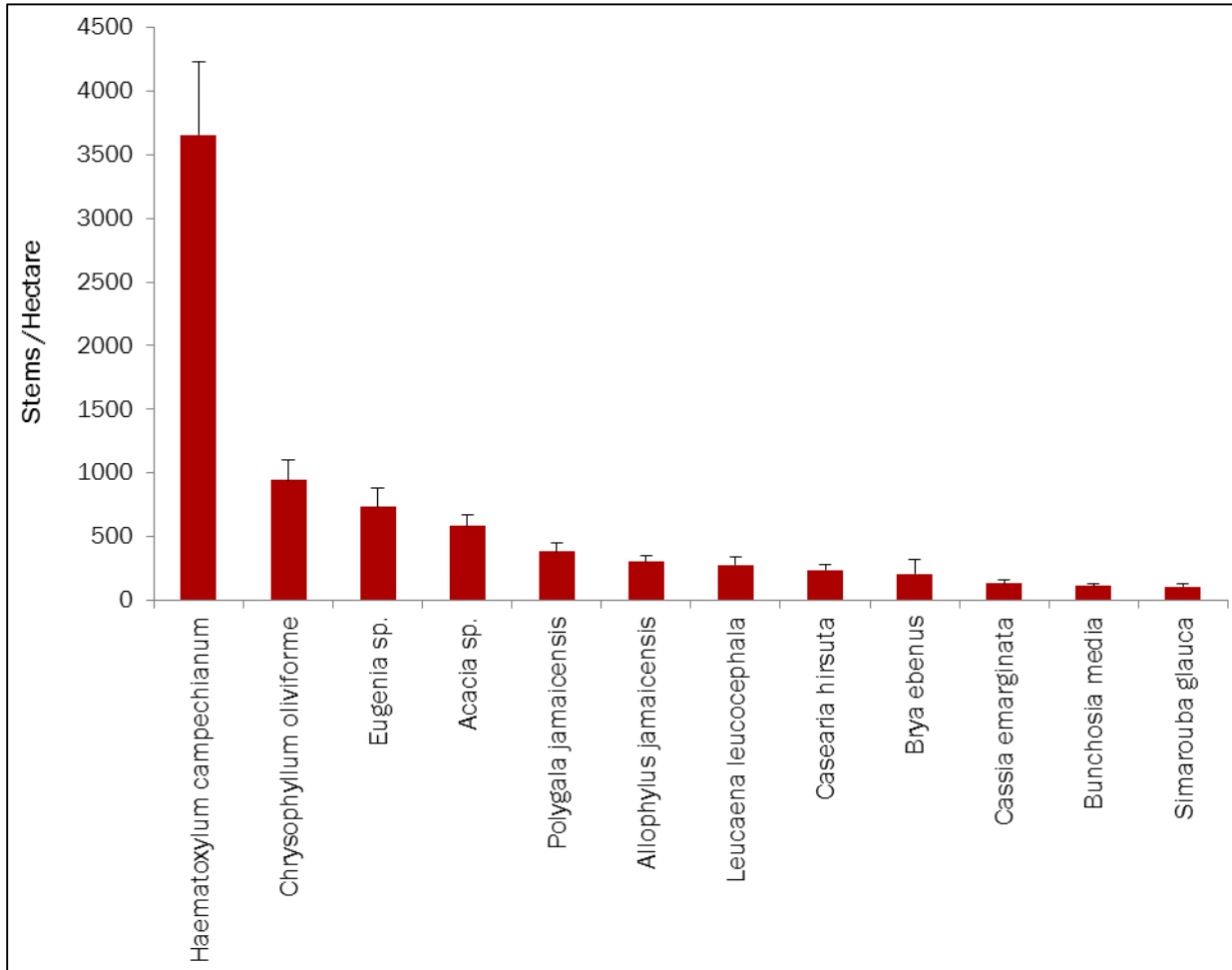

Figure 4-34 Density per unit area of overall stems for the 12 most abundant species in the study area

**Abundance**

Figure 4-34, shows the eighteen most abundant seedling species. *Haematoxylum campechianum*, *Eugenia sp*, *Chrysophyllum oliviforme* and species of *Acacia* were the most abundant seedlings with *haematoxylum campechianum* being significantly more abundant than other seedlings. The most abundant sapling species (Figure 4-36) followed a similar pattern as the abundant seedling species with *Haematoxylum campechianum*.

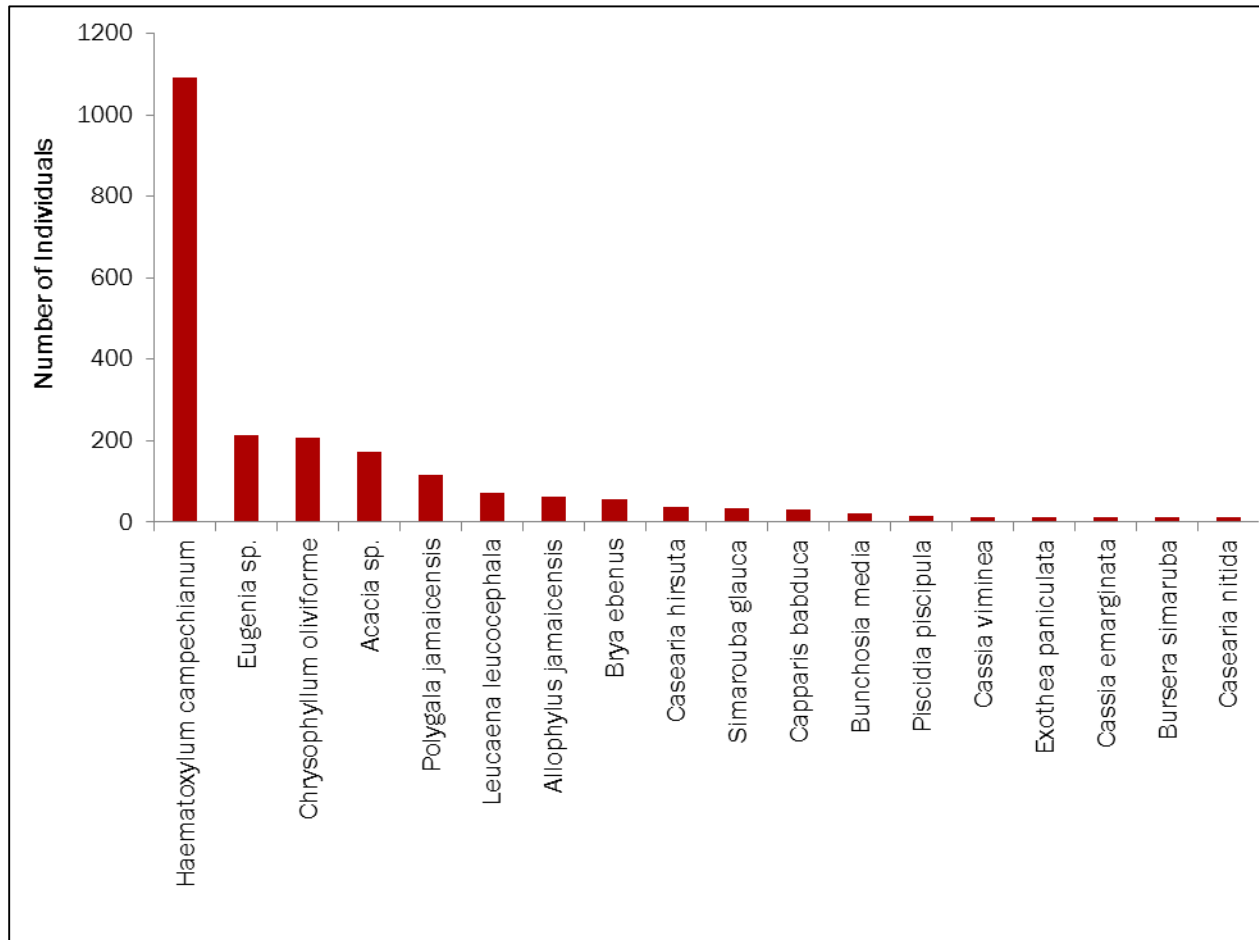

Figure 4-35 Seedling abundance for the 15 most common species in the study area

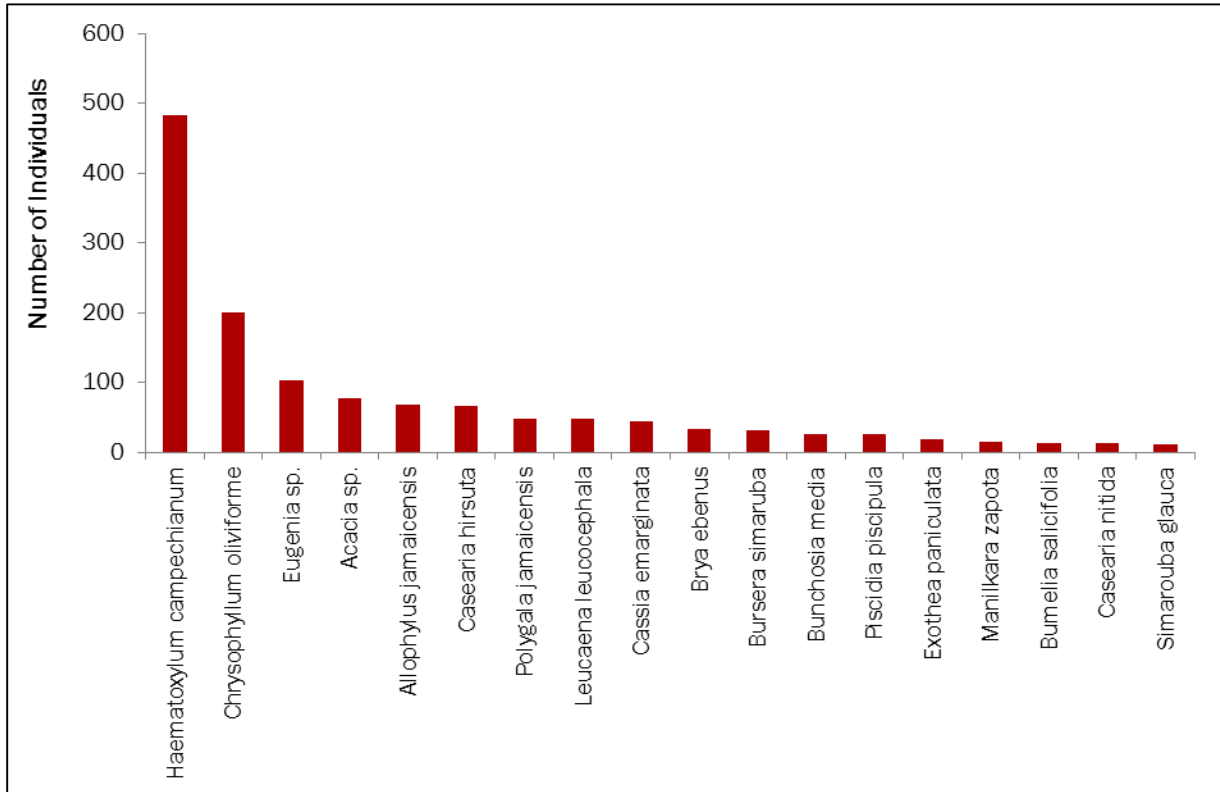

Figure 4-36 Sapling abundance for the 18 most common species in the study area.

**Stem Distribution**

A total of 3705 stems were recorded in our survey. Of this total seedlings represented 61.51 %, saplings 38.11% and trees (stems > 10 cm DBH) accounted for 0.38% (Figure 4-37). Only 13 trees comprising species had DBH greater than or equal to 10 cm; *Bursera simaruba* (red birch) comprised 5 of the 13 individuals recorded. 13 stems would have a density of approximately 56 trees per hectare.

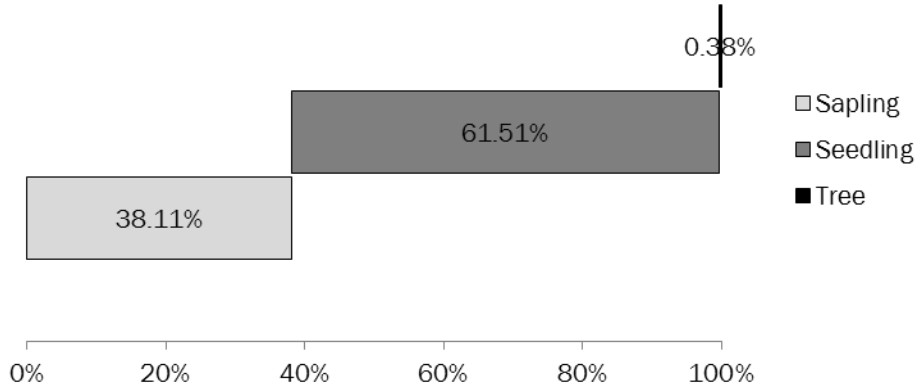

Figure 4-37 Graph showing proportion of stems recorded in the study area



## Diversity

---

Two indices were considered for calculating the diversity of the community, Simpson's Index and Shannon - Wiener's Index. The Simpsons index is more sensitive to more abundant species than rare species (Barbour, Burk, and Pitts 1987). The Shannon Weiner Index was therefore used to measure diversity within the sample area since only six species of trees and seven species of seedlings recorded abundance greater than fifty and sixty individuals respectively (Figure 4-35 & Figure 4-36). The index value calculated was 2.32.

Please refer to Appendix 5 for complete species listings and other detailed results.

### 4.2.1.4 Discussion

#### Ecological Health and Function

---

The area is highly disturbed with very few trees over 10 cm DBH. Sources of disturbance include areas cleared for coal kiln, trees removed for use as charcoal as fence posts, numerous trails used to access the resources within the area. During the 'walk through' 15 areas recently or currently been used as coal kilns were recorded. As a result of these disturbances, the canopy layer is short (3-6 m) and open. Due to constant tree removal it is unlikely that large trees will dominate and that the canopy will reach heights greater than 7m (mean 3.1 m). Despite the disturbances observed the study site functions as a habitat for birds and other animals; three bird nests were seen in the vicinity of the transect line and numerous doves could be seen foraging through the vegetation and along the trails. Various species of birds were observed throughout the day.

#### Vegetation Structure and Composition

---

The vegetation within the area sampled was recorded as trees and shrubs; shrubs included: true shrubs, vines and grasses. Three species of grass were recorded comprising two families; these species were: *Panicum maximum* *Scleria secans* and *Lasiacis divaricta*, with *Lasiacis divaricta*, being the most abundant species and *Panicum maximum* represented occasionally. Ten species of vines comprising eight families were recorded; the family Papilionaceae (Fabaceae) accounted for three species. The most abundant vines included: *Mucuna pruriens*, *Passiflora suberosa* and *Ipomoea sp.* The most abundant shrubs were *Lantana camara*, *pruriens*, *Pisonia aculeata*, *Croton linearis* and *Stachytarpheta jamaicensis*.

For the purposes of this discussion shrubs will be taken to mean true shrubs, vines and grass combined. The average percentage cover of all shrubs recorded in the plots is seventy-three (73) percent. All plots recorded, had percentage cover of at least 50% except for those that had major tracks or coal kiln within them. The high percentage cover and species composition of shrub is an indication of the high level of disturbance. This was evident by the used and unused coal kilns as well as the number of instances of tree removal observed. Shrub cover increased in areas recently cleared of vegetation and decreased where tall saplings dominate and trails were present.

Sixty species of trees representing thirty one families were recorded. The following families Boraginaceae, Mimosaceae, Caesalpiniaceae, Flacourtiaceae, Anacardiaceae, Malpighiaceae, Myrtaceae, Sapindaceae and Sapotaceae represented thirty three of the sixty species recorded. The

calculated Shannon-Weiner species diversity index ( $H'$ ) is 2.3; this may be considered low.  $H'$  indices ranging from 3 – 5 in tropical forest are considered intermediate to diverse (Barbour, Burk, and Pitts 1987, Ayyappan and Parthasarathy 2001, Devi and Yadava 2006). Ayyappan and Parthasarathy (2001) working in tropical evergreen forest obtained  $H'$  index values from 3.5 – 3.7 for moderately disturbed forest to undisturbed forest.

*Haematoxylum campechianum*, *Eugenia sp*, *Chrysophyllum oliviforme* and species of *Acacia* were among the most abundant species of seedlings and saplings; however *Haematoxylum campechianum* was significantly more abundant in both cases (Figure 4-35 and Figure 4-36). When the abundance of seedlings, saplings and seedlings were examined (total number of stems recorded - 3705) seedlings were found to represent 61.51 %, saplings 38.11% and trees (stems > 10 cm DBH) accounted for 0.38% (Figure 4-37). The low abundance of trees reflects constant disturbance (removal of trees for use as charcoal and fence post) preventing seedlings and saplings from reaching maturity. Only 13 trees (DBH > 10cm) were recorded in all plots, *Bursera simaruba* (Red birch) accounted for 5 of those individuals; this is due to preferential removal of trees/saplings other species for use as charcoal (red birch is not commonly used for charcoal). The high level of disturbance may also affect the distribution of saplings to seedlings; some species recorded similar or greater abundance of saplings than seedlings, this is not typical of undisturbed forests which show significantly greater abundance of seedlings than saplings. These species include: *Bursera simaruba* and *Brya ebenus* which are typical of dry forests. McLaren (2003) and Lévesque (2011a, b) noted that regeneration by coppicing was more significant than regeneration by seeds in dry forest after disturbance. Numerous instances of coppicing were observed throughout the sample area.

## 4.2.2 Fauna

### 4.2.2.1 Invertebrates

#### Method

---

Invertebrate assessments focused on larger species (body length  $\geq 3$  mm). A road way and pathways served as transects across the site. Because the area was dominated by grass there was very good visibility. All species observed within a belt of  $\pm 5$  m along the transects were recorded. Litter was also searched. All species detected were identified in the field, if possible.

Specimens of some species were collected for verification or identification in the laboratory. To increase the number of species collected from the vegetation, a sweep net was used along the transect. A 15 cm sweep net with cotton bag was swept from side through the shrub and herb layer while the researcher walked along the transect. The material collected was placed in killing jars then later transferred to plastic jars for transportation to the laboratory. In the laboratory, the animals were removed, sorted, labelled and stored. The species were later identified.

#### Results

---

Twenty nine species of invertebrates were recorded (Table 4-12). These include six species of beetles, nine species of butterflies. Two of Jamaica's three species of scorpions were also recorded; these were

the two native species (the other was introduced) and both have a very wide distribution across the island. No species of special conservation significance was recorded.

Table 4-12 Invertebrate fauna recorded at study site

Order	Genus and Species	Common Name
Coleoptera (Beetles)	<i>Coleomegilla cubensis</i>	Lady bird beetle
	<i>Oxymerus sp.</i>	
	<i>Oreodera sp.</i>	
	<i>Chlorida festiva</i>	
	<i>Neoclytus longipes</i>	
	<i>Derancistrus lineatus</i>	
Hemiptera	<i>Loxa viridis</i>	Stink bug
Lepidoptera	<i>Heliconius charitonius</i>	Zebra
	<i>Dryas iulia delia</i>	Dryas;
	<i>Eurema spp.</i>	Little Sulphur
	<i>Phoebis sennae</i>	Cloudless sulphur
	<i>Ascia monuste</i>	Cabbage white
	<i>Kricogonia lyside</i>	Lignumvitae butterfly
	<i>Papilio andraemon</i>	Citrus swallowtail
	<i>Battus polydamas</i>	Battus; Jamaican Polydamus
	<i>Danaus plexipus</i>	Monarch; Milkweed butterfly
	<i>Ascalapha odorata</i>	Duppy bat
Orthoptera (Grasshopper & Crickets)	<i>Halpithus sp.</i>	Cricket
	<i>Orphullela punctata</i>	Small grasshopper
Hymenoptera (Ants, Wasps & Bees)	<i>Campanotus sp.</i>	Carpenter ant; Big red ant
	<i>Pheidole sp.</i>	Biting ant
	<i>Apis mellifera</i>	Honey bee
	<i>Polistes crinitus</i>	Red wasp
Damselflies)	<i>Tramea abdomiinalis</i>	Needle case
Diptera (Flies)	<i>Paecillathrax lucifer</i>	Bee fly
	<i>Musca domestica</i>	
NEUROPTERA (Lace wings & ant lions)	<i>Chrysopa bicornea</i>	Ant lion; Nanny goat
ARACHNIDA (Scorpions)	<i>Diplocentrus scaber</i>	Scorpion
	<i>Cenrtuoides insularis</i>	

#### 4.2.2.2 Vertebrates

##### Avifauna

##### Method

Fixed Radius Point Count Census Method was used. This Point Count method is based on the principle of counting birds at a defined point or spot and determining the distance of each bird censured. A point is selected and then all bird contacts (seen and heard) are recorded, with a determination of distance given (< 25m or >25m) for each contact. This is done for a predetermined time, usually 10

minutes, before moving to another point at a specified distance away. Points for this survey were at most 40m apart.

### Results

A total of 21 bird species were observed. The breakdown is as follows:

- 4 Endemics
- 3 Endemic Subspecies
- 13 Residents
- 1 Summer Resident

**Table 4-13 List of bird species observed from conducted counts and transect**

Status: E – Endemic; ES – Endemic Sub-species; R – Resident; I – Introduced; Summer Resident – SR

Common Name	Scientific Name	Status
Black Whiskered Vireo	<i>Vireo altiloquus</i>	R
Jamaican Vireo	<i>Vireo modestus</i>	E
Jamaican Tody	<i>Todus</i>	E
Jamaican Woodpecker	<i>Melanerpes radiolatus</i>	E
Jamaican Oriole	<i>Icterus leucopteryx</i>	ES
Red-Billed Streamertail	<i>Trochilus polytmus</i>	E
Caribbean Dove	<i>Leptoptila jamaicensis</i>	R
Yellow-faced Grassquit	<i>Tiaris olivacea</i>	R
Common Ground Dove	<i>Columbina passerina</i>	R
White-Winged Dove	<i>Zenaida asiatica</i>	R
Yellow-faced Grassquit	<i>Tiaris olivacea</i>	R
Bananaquit	<i>Coereba flaveola</i>	ES
Vervain Hummingbird	<i>Mellisuga minima</i>	R
Northern Mockingbird	<i>Mimus polyglottos</i>	R
Smooth-billed Ani	<i>Crotophaga ani</i>	R
Black Whiskered Vireo	<i>Vireo altiloquus</i>	SR
American Kestrel	<i>Falco sparverius</i>	ES
Greater Antillean Grackle	<i>Quiscalus niger</i>	R
Loggerhead Kingbird	<i>Tyrannus caudifasciatus</i>	R
Black-faced Grassquit	<i>Tiaris bicolor</i>	R
White-crowned Pigeon	<i>Pategoineas leucocephala</i>	R

### Other Vertebrates

#### Method

Potential habitats of amphibians were examined; these include stone piles, under logs etc. The vegetation was observed for the presence of any lizards.

## Results

A few mongooses were observed; this was not surprising given the proximity of human habitation. No frogs were recorded; this is one of the driest parts of Jamaica and low population of frogs is expected. The only lizard observed was *Anolis lineatopus*, the common tree lizard.

### 4.2.3 Ecological Carrying Capacity

Ecological Carrying Capacity can be defined as the ability of the system to maintain the current species population size and dynamics (these are the interactions between flora and fauna in a given area). The proposed project area consists of a highly disturbed system under constant anthropogenic stress. The system does however support several plant species and a limited number of faunal species. The shift in land use and resultant change in habitat may potentially have an impact the carrying capacity of the surrounding areas. Due to the disturbed and stressed nature of the proposed project area and surrounding areas, the increased stress on resources (space, food availability and other niche requirements) is expected to be minimal

The surrounding areas may become more vulnerable to manmade stresses such as charcoal burning, farming and animal husbandry. This may in turn affect/reduce the actual carrying capacity of the surrounding lands over time. The greatest impact is anticipated to be the impact on the livelihoods of persons who use the proposed project site for charcoal burning activities and animal husbandry.

## 4.3 SOCIAL

### 4.3.1 Demography, Services and Infrastructure

#### 4.3.1.1 Approach

##### Social Impact Area

---

In order to assess the various social elements of the proposed project, a Social Impact Area (SIA) is established. An SIA may be described as the estimated spatial extent of the proposed project's effect on the surrounding communities. Demographic analyses are carried out utilising this SIA demarcation, and social services, infrastructure and industrial facilities are described in relation to the SIA as well. For the purposes of this project, the SIA was demarcated as two (2) kilometres from the proposed development area. As seen in Figure 4-38, the SIA coincides with the western section of St. John's West community (western Spanish Town), and parts of the Kitson Town community make up the north-western section of the SIA. The settlements of Old Road, Naseberry Grove, Byles, St. John's Heights, Bellevue Heights, Green Acres and Johnston Pen are situated within the demarcated SIA.

##### Demographic Analyses and Census Database

---

Population data were extracted from the STATIN 2011 and 2001 Population Census database for the SIA by enumeration district. This was undertaken using Geographic Information Systems (GIS)



methodologies, which were also used to derive visual representations of the data. In order to derive information from the census data the following computations were made:

- **Population growth** - was calculated using the formula [ $i_2 = i_1 (1 + p)^x$ ]; where  $i_1$  = initial population,  $i_2$  = final population,  $p$  = actual growth rate and  $x$  = number of years.
- **Population density** - was derived by dividing the population by the land area. This is useful for determining the locations of greater concentrations of population.
- **Dependency ratio** - was calculated using the formula [child population + aged population / working population X 100], where the child population is between ages 0-14, the aged population is 65 & over and the working population is between ages 15-64 years. This ratio is useful for understanding the economic burden being borne by the working population.
- **Male sex ratio** - was calculated by using the formula [male population / female population X 100]. This in effect denotes the amount of males there are to every 100 females and is useful for determining the predominant gender in a particular area.
- **Domestic water consumption** - was calculated based on the assumption that water usage is 227.12 litres/capita/day and sewage generation at 80% of water consumption. Water consumption for workers in Jamaica is calculated at 19 litres/capita/day and sewage generation at 100% water consumption.
- **Domestic garbage generation** - was calculated at 4.11 kg/household/day (National Solid Waste Management Authority).

#### Other GIS Data

---

Geospatial data for various services and infrastructure, including schools, health centres, hospitals, police stations, fire stations and post offices were obtained from Mona Geoinformatics Institute. Additional data is also gleaned from the 1984 national topographic maps (metric series) and satellite imagery available for the project.

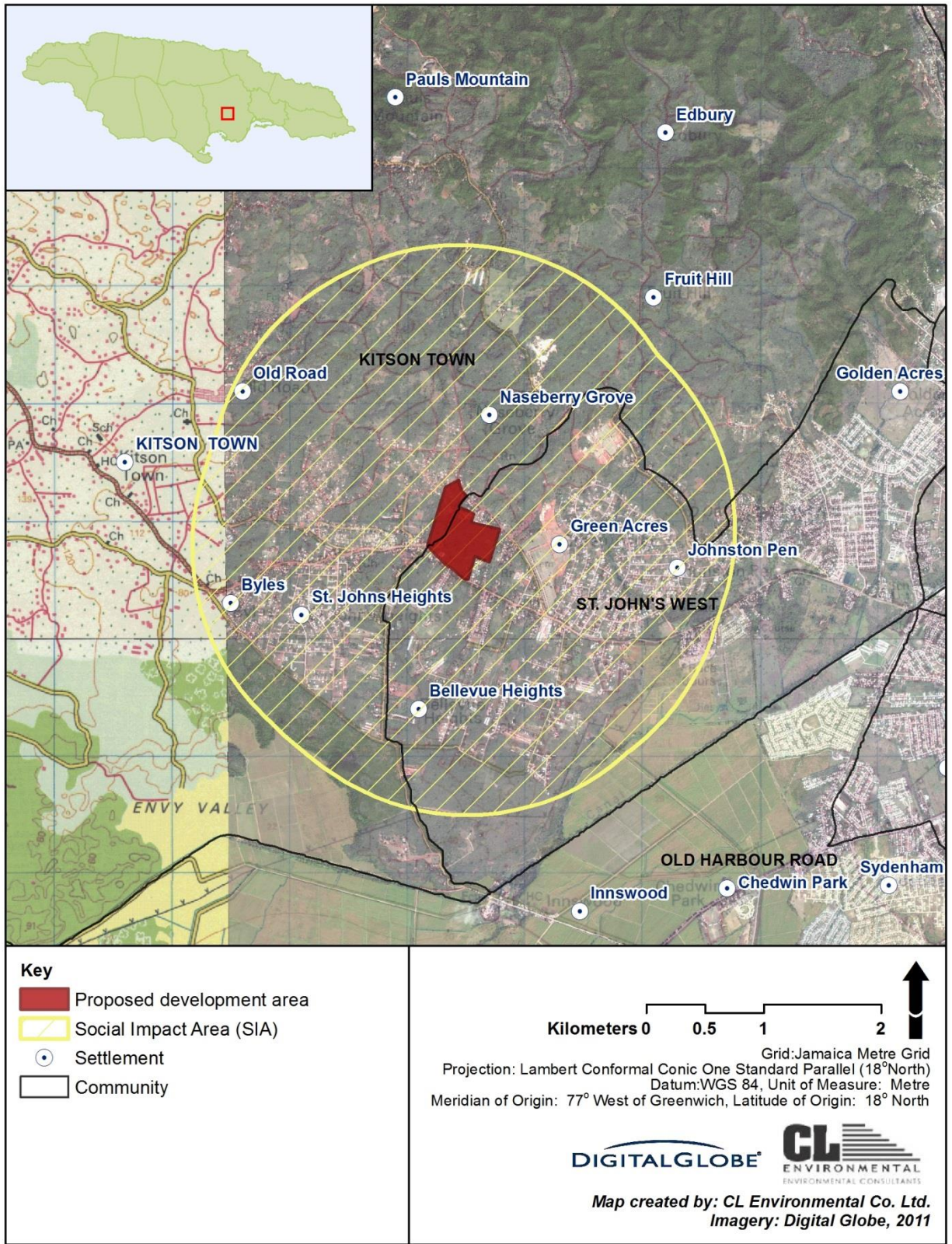

Figure 4-38 Map showing the Social Impact Area (SIA)

### 4.3.1.2 Demography

#### Population Growth Rate

The total population within the SIA in 2011 was approximately 7,788 persons (STATIN 2011 Population Census). Examination of the 2001 population data showed that there were approximately 6,159 persons within the 2 km radius of the proposed development area in 2001. From this population, and that calculated for the year 2011 (7,788 persons), it was estimated that the actual growth within the SIA between 2001 and 2011 was approximately 2.37% per annum. Based on this growth rate, at the time of this study (2014), the population was approximately 8,356 persons and is expected to reach 15,026 persons over the next twenty five years if the current population growth rate remains the same.

The annual SIA growth rate of 2.37% is greater than the regional rate of 0.72% for St. Catherine and 0.36% for the island (2001-2011)<sup>6</sup>. This higher growth rate for the SIA is expected, owing to residential development between 2001 and 2011 in the SIA.

#### Age & Sex Ratio

The segment of a population that is considered more vulnerable are the young (children less than five years old) and the elderly (65 years and over). In the SIA population, approximately equal numbers for each category were considered vulnerable, wherein 7.4% comprised the young category and 7.9%, the 65 years and older category.

Table 4-14 shows the percentage composition of each age category of the population. This is compared on a national, regional and local (SIA) level. Percentage age distribution is comparable between the SIA, the parish of St. Catherine and the island for the 0-14 years age cohort (26.9%, 26.1% and 26.1% respectively). As mentioned preciously, elderly persons aged 65 years and greater make up 7.9% of the SIA population; this is comparable to the national figure (8.1%) and only slightly greater than the St. Catherine figure of 7.0%. Within the SIA, the 15-64 years age category accounted for 65.2% and can therefore be considered a working age population. This SIA percentage was similar to that for the nation (65.9%) and slightly less than that for the parish of St. Catherine (66.9%) (Table 4-14).

**Table 4-14 Age categories as percentage of the population for the year 2011**

Age Categories	Jamaica	St. Catherine	SIA
0-14	26.1%	26.1%	26.9%
15 - 64	65.9%	66.9%	65.2%
65 & Over	8.1%	7.0%	7.9%

Source: STATIN Population Census 2011

As seen in Figure 4-39, Census 2011 data indicated that there were approximately 2% more females within the 0-14 years age cohort when compared to males; however slightly more males than

<sup>6</sup> <http://statinja.gov.jm/Census/Census2011/Census%202011%20data%20from%20website.pdf>



females in the 15-64 and 65 & over cohorts. Sex ratio for all age cohorts within the SIA was calculated to be 99.4 males per one hundred females.

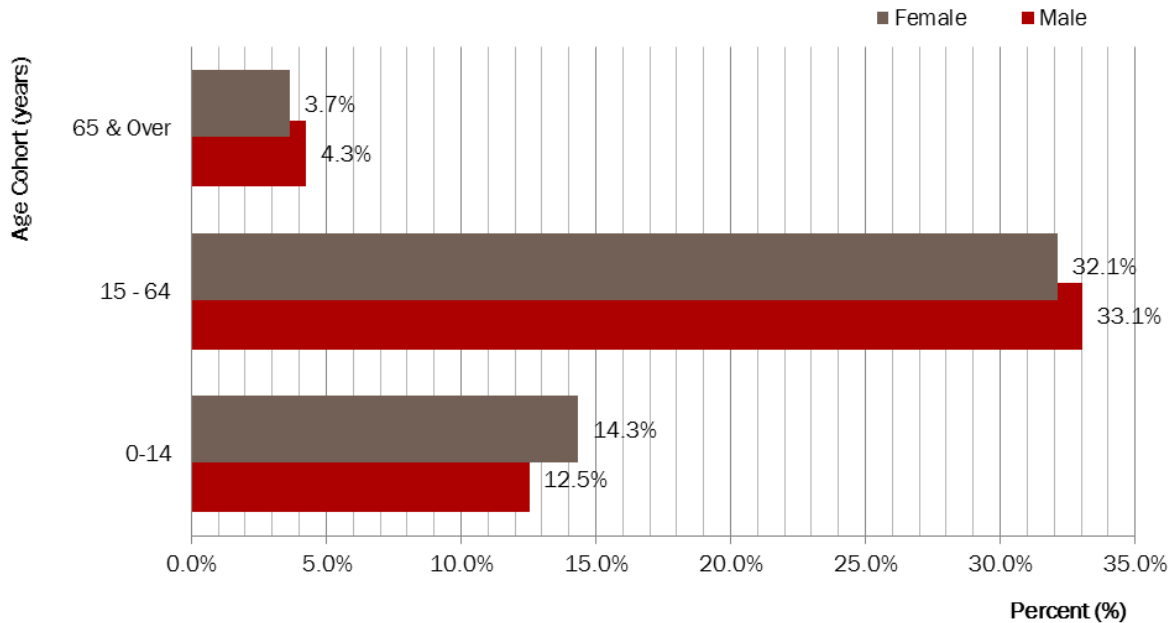

Source data: STATIN Population Census 2011

Figure 4-39 Male and female percentage population by age category for the SIA in 2011

### Dependency Ratios

The child dependency ratio for the SIA in 2011 was 412.3 per 1000 persons of labour force age; old age dependency ratio stood at 121.5 per 1000 persons of labour force age; and societal dependency ratio of 533.9 per 1000 persons of labour force. This indicates that the youth (child dependency) are far more dependent on the labour force for support when compared with the elderly. Comparisons of the child dependency ratios at varying extents indicate that the child dependency ratio for the study area (SIA) were higher than the national and regional figures (Figure 4-40).

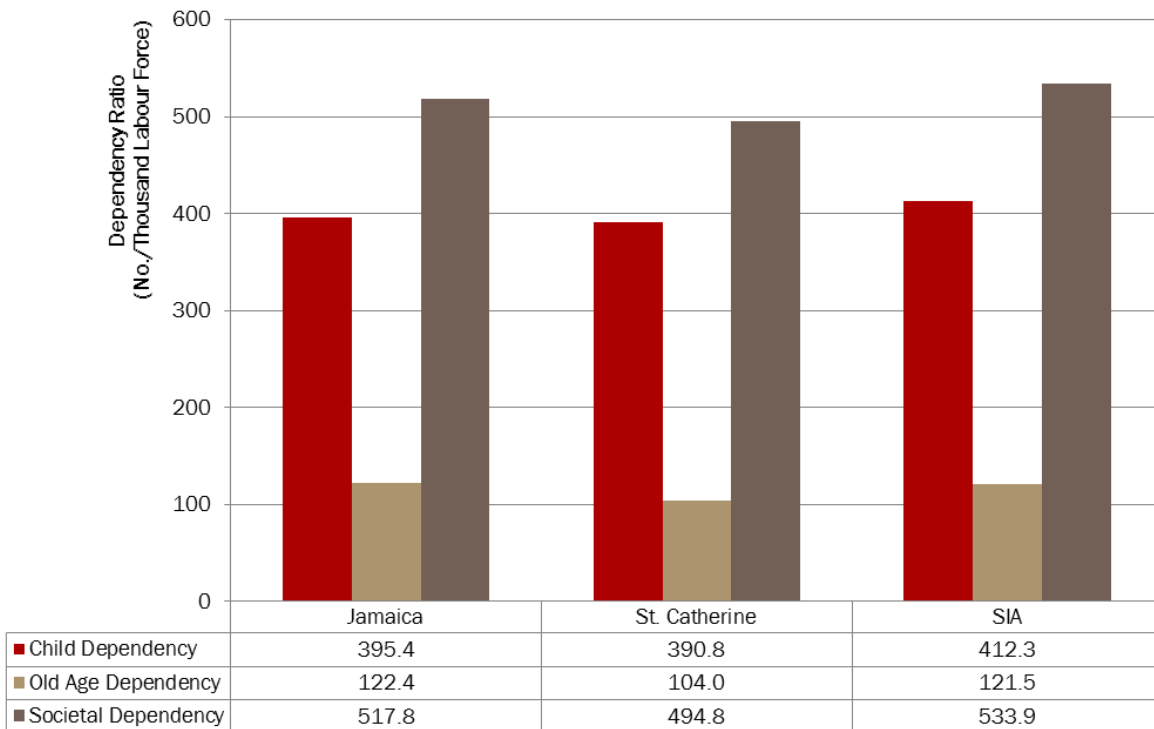

Source: STATIN Population Census 2011

Figure 4-40 Comparison of dependency ratios for the year 2011

### Population Density

The land area within the SIA was calculated to be approximately 17.23 km<sup>2</sup>. With a population of 7,788 persons, the overall population density was calculated to be 452 persons/km<sup>2</sup>. This population density is considerably higher than the national level (245.5 persons/km<sup>2</sup>), and also higher than the St. Catherine regional density of 433.6 persons/km<sup>2</sup> (Table 4-15). As mentioned previously, a number of residential developments are located within the SIA, such as Green Acres, Bellevue Heights, St. Johns Heights and Johnston Pen; this justifies the relatively high population density calculated.

Table 4-15 Comparison of population densities for the year 2011

Source: STATIN Population Census 2011

Category	Jamaica	St. Catherine	SIA
Land Area (km <sup>2</sup> )	10,991.0	1,190.6	17.2
Population	2,697,983	516,218	7,788
Population Density	245.5	433.6	452.0

Population is not evenly distributed within the SIA. As seen in Figure 4-41, the higher numbers of persons are seen located within the centre of the SIA and surrounding the proposed development area (according to 2011 Census data).



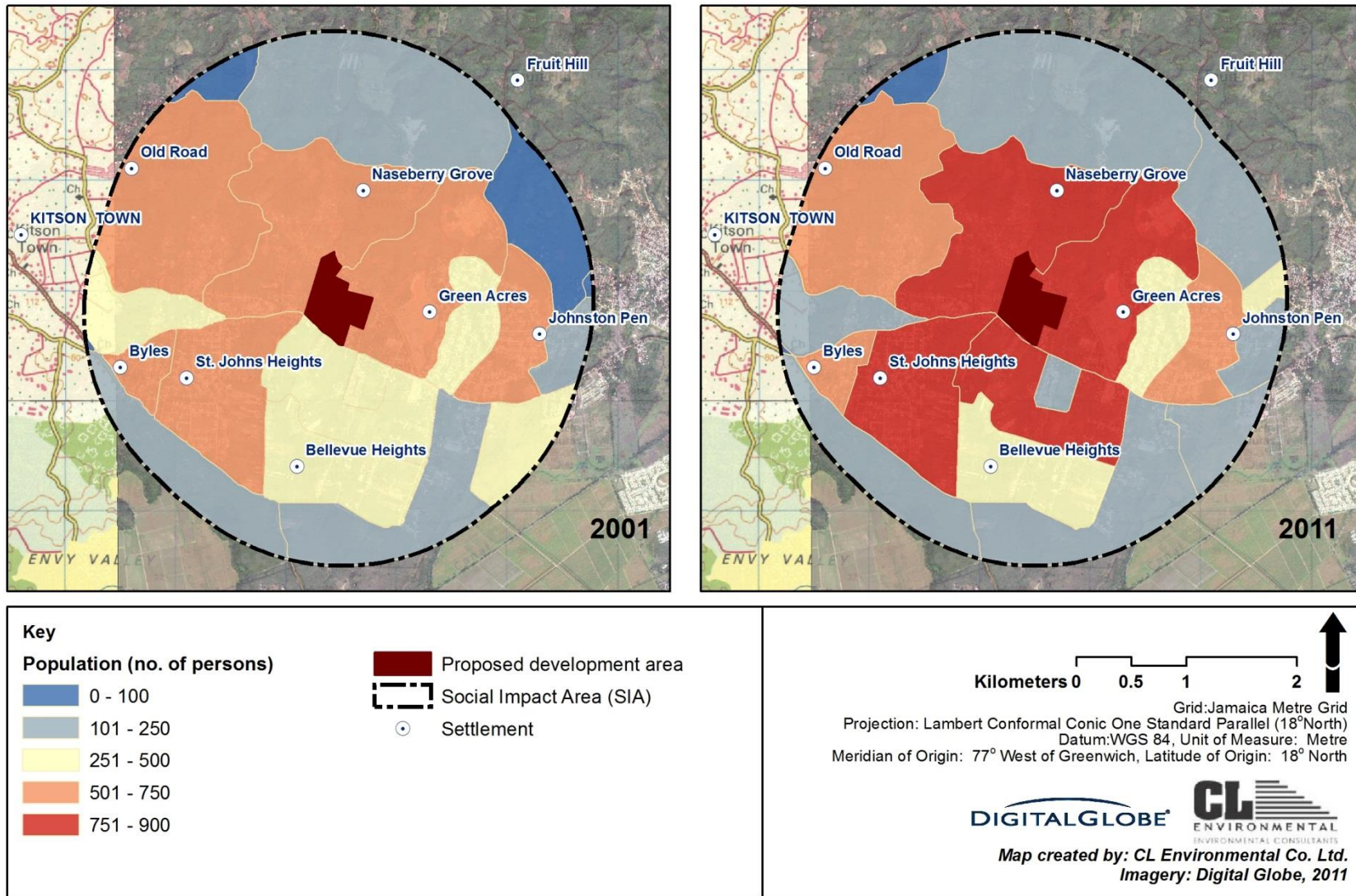

Data source: STATIN Population Census 2011 and 2001

Figure 4-41 SIA 2001 and 2011 population data represented in enumeration districts

### **Population Growth Areas**

---

Figure 4-41 depicts the population within each enumeration district (ED) for the years 2001 and 2011. Total SIA population increased from 6,159 persons to 7,788 persons within this ten year timeframe. Population increases are observed primarily in those EDs surrounding the proposed development area.

#### **4.3.1.3 Poverty**

The poverty GIS dataset developed by the Planning Institute of Jamaica (PIOJ) (with contributions from STATIN, Social Development Commission (SDC) and the University of Technology), primarily identifies areas of poverty by community. As described by PIOJ, for the 2002 poverty map:

The indicators utilized were those that best predicted per capita consumption levels in households based on data from the Jamaica Survey of Living Conditions (JSLC) 2002. Relevant variables that were common to this survey and the Population Census 2001 were selected and tested for similarity. The satisfactory variables were then applied to the census data to obtain estimates of the consumption levels of the households that had consumption levels islandwide. Members of households that had consumption levels below the poverty line for the region in which their household was located were deemed to be in poverty. The proportion of persons in poverty in each community was used to rank the 829 communities.

As seen in Figure 4-42, the SIA population generally has less than 25% of persons living in poverty (St. John's West and Kitson Town).



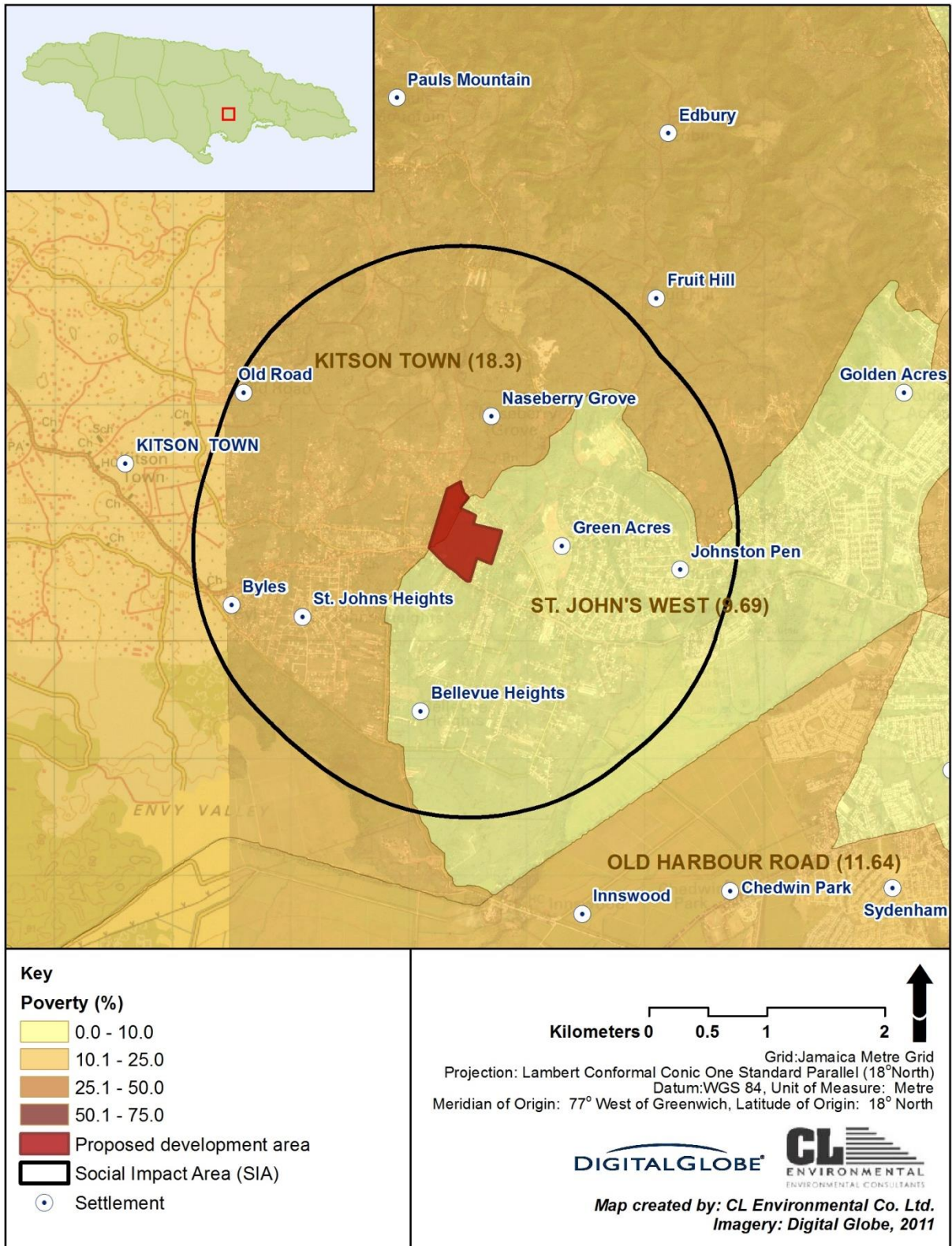

Data source: PIOJ (with contributions from STATIN, SDC and the University of Technology)

Figure 4-42 Proportion of persons in poverty in each community

#### 4.3.1.4 Education

The educational attainment of persons in 2011 for the national, regional and SIA extents are represented in Table 4-16. When educational attainment within the SIA is calculated as a percentage, it becomes evident that there is a propensity towards the attainment of a primary and secondary school education. Forty four percent of the SIA population attained a secondary school education, followed by 32.9% attaining a primary education. Secondary educational attainment is comparable to the Jamaica and St. Catherine figures (45.7% and 44.7% respectively).

There are higher percentages of those attaining a university or other tertiary level in the SIA (12.9%) when compared to the national combined total of 9.9% for Jamaica. Statistics for pre-primary and no education are similar amongst all extents examined.

**Table 4-16** Population 3 years old and over by highest level of educational attainment as a percentage, for the year 2011

	Jamaica	St. Catherine	SIA
No Schooling	0.7%	0.6%	0.6%
Pre Primary	4.8%	4.9%	4.7%
Primary	34.4%	32.0%	32.9%
Secondary	45.7%	44.7%	43.6%
University	4.7%	5.9%	6.1%
Other Tertiary	5.2%	6.8%	6.7%
Other	0.5%	0.7%	0.9%
Not Stated	4.0%	4.4%	4.5%

Source: STATIN Population Census 2001

The relatively high proportion of the population in proximity to the project location attaining a secondary education, as well as tertiary education suggests that the labour pool is relatively educated, and as such, there should be no problem in obtaining non-technical workers from the community. This is shown in Figure 4-43, which also depicts the location of schools in proximity to the proposed location. No schools are found within the 2 km buffer SIA; the closest schools in proximity to the proposed location are situated approximately 3 km west (Kitson Town All Age) and 3.5 km east (Cassava River and Friendship Primary) and northwest (Paul Mountain All Age) of the proposed site.



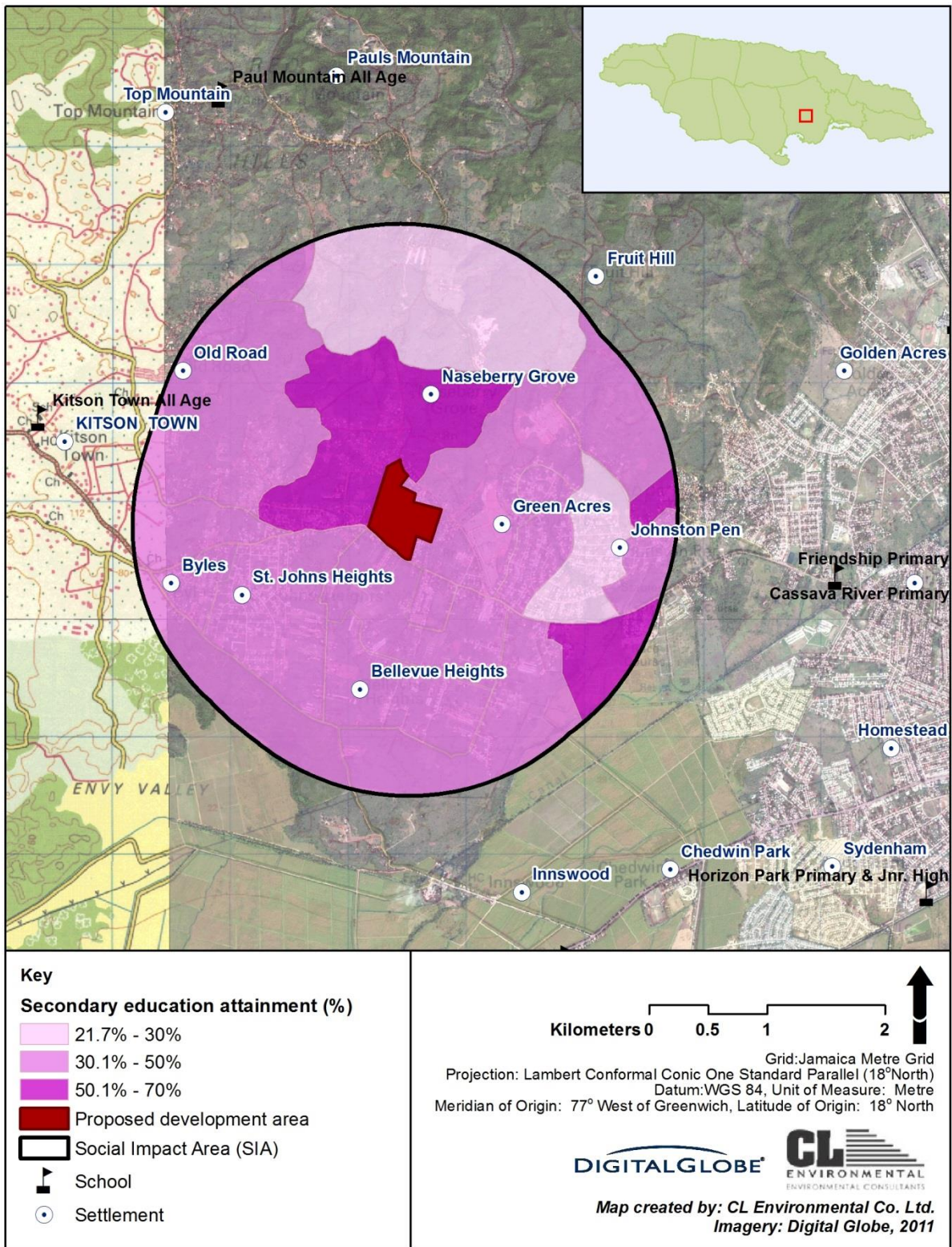

Source: Education (STATIN Population Census 2011), Schools (MGI)

Figure 4-43 Percentage population attaining a secondary education within the SIA



#### 4.3.1.5 Housing

For the purposes of this study the definition of housing unit, dwelling and household are those used in the population census conducted by the Statistical Institute of Jamaica (STATIN). The definition states that:

- A **housing unit** is a building or buildings used for living purposes at the time of the census.
- A **dwelling** is any building or separate and independent part of a building in which a person or group of persons lived at the time of the census”. The essential features of a dwelling unit are both “separateness and independence”. Occupiers of a dwelling unit must have free access to the street by their own separate and independent entrance(s) without having to pass through the living quarters of another household. Private dwellings are those in which private households reside. Examples are single houses, flats, apartments and part of commercial buildings and boarding houses catering for less than six boarders.

There were 2,429 housing units within the SIA in 2011. Approximately 98.3% of the housing units in the SIA were of the separate detached type, 0.8% were attached, 0.5% were improvised units and 0.5% residents did not report the type of housing unit (Figure 4-44).

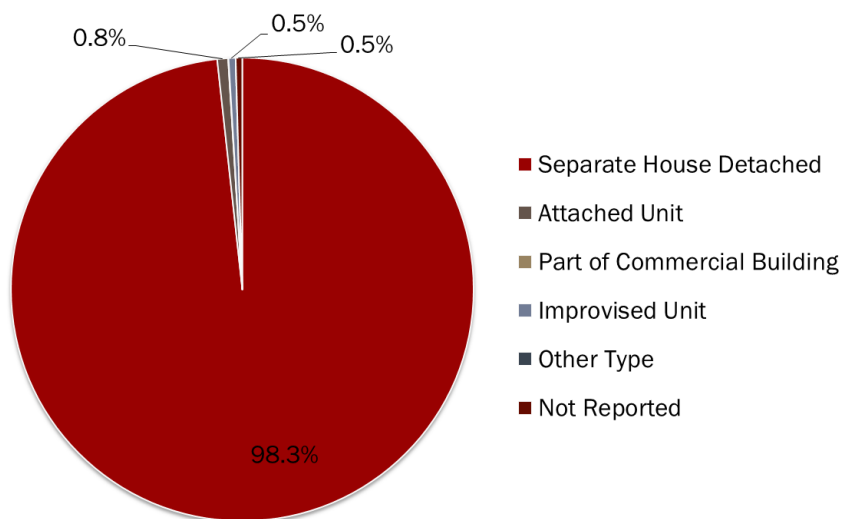

Source: STATIN Population Census 2011

Figure 4-44 Percentage of housing units by type within the SIA

#### 4.3.1.6 Infrastructure

##### Lighting

The percentage of households using kerosene as their main means of lighting in the SIA (1.2%) was lower than the Jamaican level (5.5%), as well as the parish extent (4.0%). Data for all extents (SIA, parish and national) comprised over 90% of households, with the SIA having a higher percentage (96.9%) than the parish and country level (93.6% and 91.9% respectively). Other means of lighting

were comparable for all extents and were below 1.0% of households. Figure 4-45 details the percentage of households using a particular category of lighting and Figure 4-46 depicts the percentage households in the SIA using electricity.

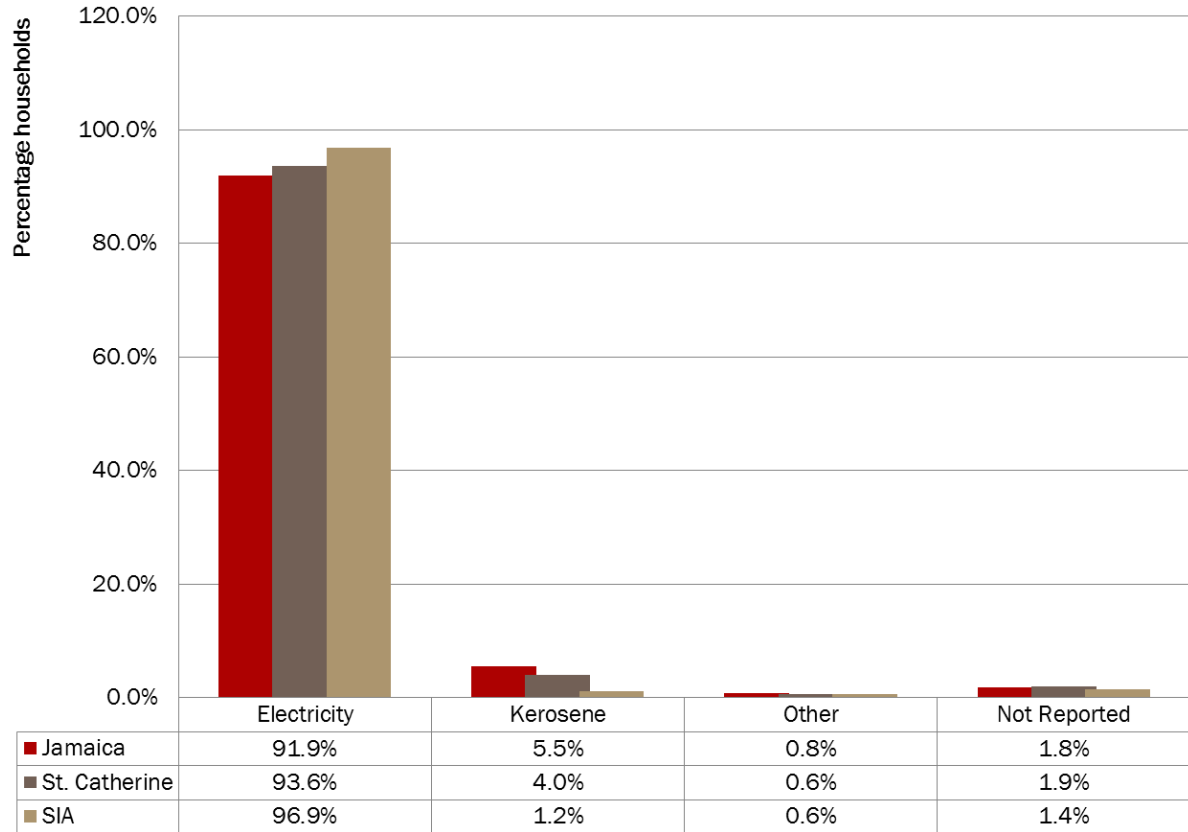

Source: STATIN Population Census 2011

Figure 4-45 Percentage households by source of lighting

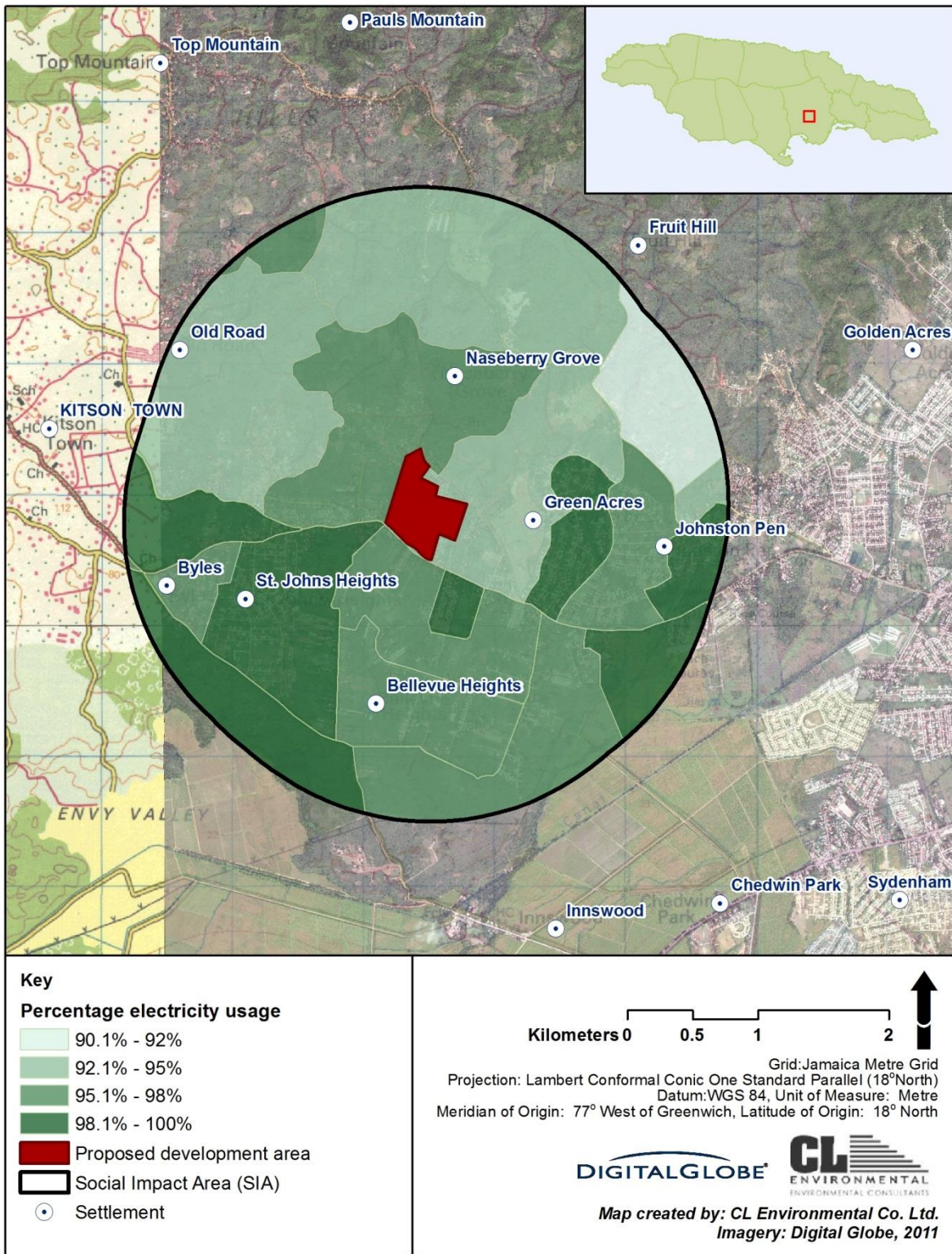

Source: STATIN Population Census 2011

Figure 4-46 Percentage dwelling with electricity within the SIA for the year 2011

### Domestic Water Supply

The National Water Commission (NWC) is the public agency responsible for providing Jamaica's domestic water supply. Forty six percent (45.7%) of the households within the SIA received their domestic water supply from a public source, this is much lower than the national and parish levels (75.5% and 82.2% respectively). About 38.5% of the households in the SIA received trucked water, 13.3% from private sources, 1.6% from other sources, 0.1% from springs or rivers and 0.8% not report. The dissimilarly between percentage households receiving water from trucked sources in the SIA (38.5%) compared to the parish and national extents (3.7% and 2.1% respectively) is worth mentioning.

**Table 4-17** Percentage of households by water supply for the year 2011

**Source:** STATIN Population Census 2011

	Category	Jamaica	St. Catherine	SIA
Public Source	Piped in Dwelling	49.7%	63.5%	38.0%
	Piped in Yard	16.5%	16.1%	6.9%
	Stand Pipe	7.1%	1.8%	0.5%
	Catchment	2.2%	0.9%	0.2%
Private Source	Into Dwelling	6.4%	4.4%	11.3%
	Catchment	9.8%	3.6%	2.0%
	Spring/ River	3.0%	3.1%	0.1%
	Trucked Water/Water Truck	2.1%	3.7%	38.5%
	Other	1.8%	1.6%	1.6%
	Not Reported	1.3%	1.2%	0.8%

Water demand for the SIA in 2014 is estimated to be 1,897,814.7 litres/day (~ 501,349.7 gals/day) and is expected to increase to 3,412,705.1 litres/day (~ 901,541.5 gals/day) over the next twenty five years based on population growth rates calculated previously.

### Wastewater Generation and Disposal

It is estimated that approximately 1,518,251.8 litres/day (~401,079.8 gals/day) of wastewater is generated within the study area (for 2014) and is expected to increase to 2,730,164.1 litres/day (~721,233.2 gals/day) over the next twenty five years based on calculated growth rates.

### Solid Waste Generation and Disposal

It is estimated that at the time of this study (2014), approximately 10,825.7 kg (~10.8 tonnes) of solid waste was being generated. The National Solid Waste Management Authority (NSWMA) is responsible for domestic solid waste collection within the study area and specifically, MPM Waste Management Ltd. covers the parish of St. Catherine. In residential areas, garbage is collected once per week. This service is provided free (partial covered by property taxes) for the households within the area. The waste is transported to the Riverton Waste Disposal Site (landfill) located in southeast St. Catherine, approximately 18 km east of the proposed development area. Riverton Waste Disposal Site is



approximately 100 acres (40.5 ha). It receives approximately 60% of the islands waste. Solid waste collection for commercial and industrial facilities is done by arrangements by these entities with private contractors.

#### **4.3.1.7 Communication**

##### **Telecommunication**

The parish of St. Catherine and the study area are served with landlines provided by LIME Jamaica Limited (formerly Cable and Wireless). Wireless communication (cellular) is provided by Digicel Jamaica Limited and LIME; a network to support internet connectivity is also provided by LIME and Flow.

##### **Post Offices**

Post offices are not found within the demarcated SIA; that found in Spanish Town is the closest to the proposed development area. The Spanish Town Post Office was established in 1671, and was the first post office in the British colonies at that time. Today, the post office may be considered a mini-commercial hub and is visited by thousands of customers who not only access the postal services, but other services such as Paymaster, PATH (Programme for the Advancement through Health and Education) payments, pension payments, NIS (National Insurance Scheme) benefits, and phone card sales<sup>7</sup>

#### **4.3.1.8 Health and Emergency Services**

##### **Health Centres**

No health centres exist within the SIA; that closest to the proposed development area is the Kitson Town Health Centre, situated approximately 2.7 km west northwest of the development area (Figure 4-47). This health centre, along with others situated in the parish of St. Catherine and depicted in Figure 4-47 (e.g. Sydenham and Spring Village) fall under the responsibility of the Southeast Regional Health Authority (SERHA). As reported in July 2010, Kitson Town Health Centre was one of 42 SERHA facilities that were rehabilitated through a \$47 million grant from the Nation Health Fund (NHF)<sup>8</sup>. The centre is a public Type 1 facility; at Type 1 facilities the population served is not more than 4,000 persons and basic maternal and child health; health education, family planning, immunization and nutrition services are offered<sup>9</sup>.

##### **Hospitals**

There are currently no public or private hospitals within the SIA. Spanish Town Hospital is closest to the site and is located in Spanish Town, approximately 8.5 km east southeast of the proposed development area. Similar to the Kitson Town Health Centre, this hospital belongs to the Southeast Regional Health Authority. It is the largest 'Type B' Hospital in the island and services include medicine, surgery, urology, radiology, paediatrics, pathology, orthopaedics, laboratory and obstetrics and

<sup>7</sup> <http://jamaica-gleaner.com/gleaner/20120714/lead/lead5.html>

<sup>8</sup> <http://jamaica-gleaner.com/latest/article.php?id=20906>

<sup>9</sup> <http://www.serha.gov.jm/HealthClassification.aspx>



gynaecology. Demands on these services increased owing to growing communities in St. Catherine such as Portmore, Eltham and Ensom City which access the hospital, as well as increased numbers of motor vehicle accident victims from nearby highways. In response to these demands, improvements to the hospital were made. For example in 2008, the Katie Hoo Haemodialysis Centre was officially opened and is equipped with seven (7) machines, six (6) stations as well as other dialysis equipment. One year following this, the King of Spain Wing opened; this is a 34 bed facility which also hosts the Physiotherapy Department. The Spanish Town Hospital currently has a total bed capacity of 600, staff complement of 320 and annual patient load of 160,000<sup>10</sup>.

### **Fire Stations**

---

The Spanish Town Fire Station is the closest fire station to the proposed development area and is situated outside the 2 km SIA, approximately 7.3 km east southeast of the proposed area (Figure 4-47). This station falls under Area III.

### **Police Stations**

---

Police stations do not exist within the 2 km SIA surrounding the proposed development area. The closest station is Guanaboa Vale Police Station, situated about 5.7 km northwest of the project area. It is part of the Saint Catherine North division (Police Area Five).

---

<sup>10</sup> <http://www.serha.gov.jm/SpanishTown.aspx>

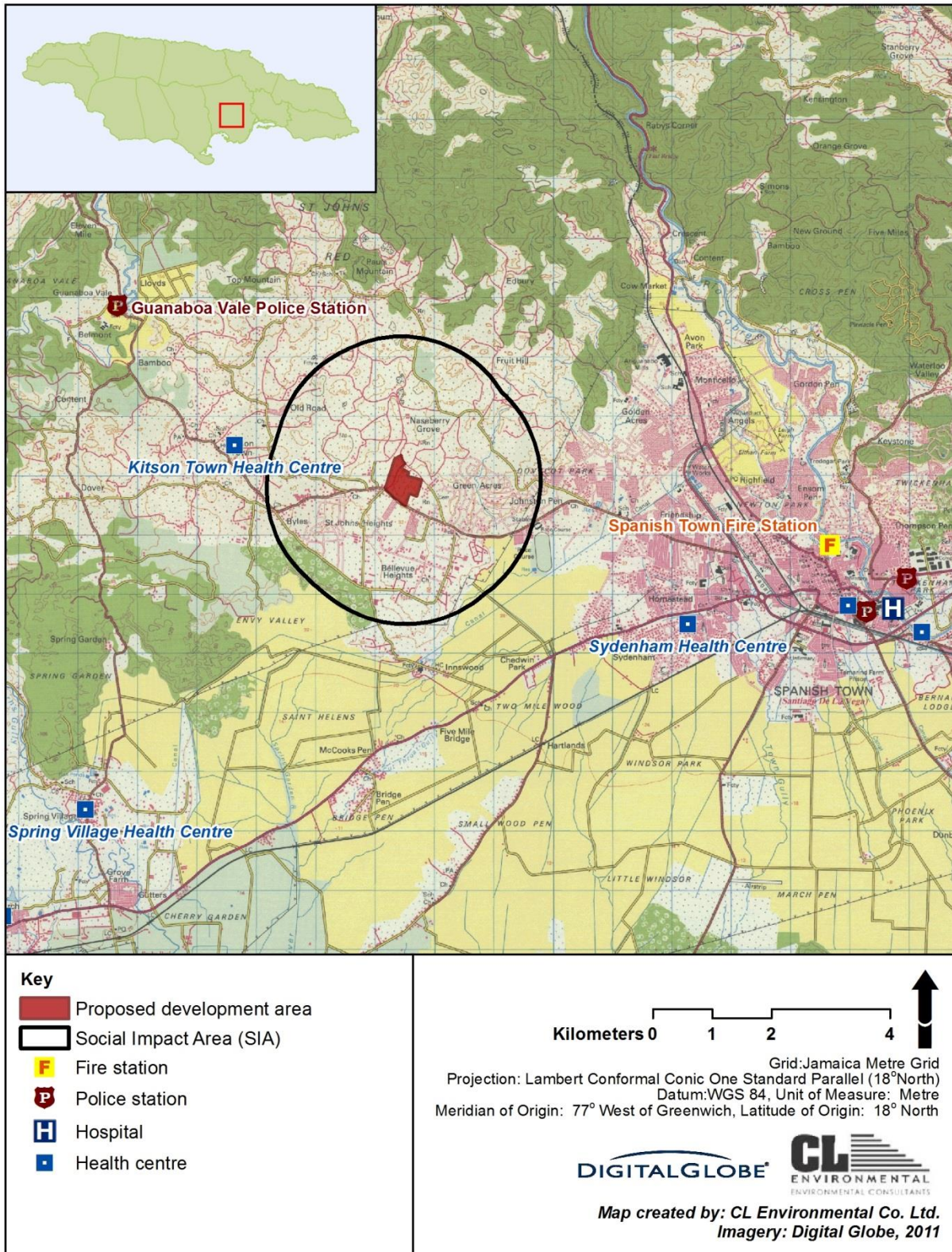

Data source: Mona GeoInformatics Institute

Figure 4-47 Health and emergency services located in and around the SIA

### 4.3.1.9 Transportation

#### Road Network

Traffic count data was obtained from the National Works Agency (NWA) for the St. John’s road section west of Featherbed Lane. The information provided was from December 6 – 20, 2007. The information provided represented traffic flow east bound and west bound. The data hourly data were averaged over the time period (Figure 4-48? and Figure 4-49).

The west bound data represents traffic flow towards the proposed cemetery. The hourly five day (Mon. – Fri.) averages of traffic flow were generally higher than the week (Mon. – Sun.) averages except early morning (12 am -5 am), mid-morning to late afternoon (10 am – 6pm) and late night to early morning (10 pm – 12 am) (Figure 4-48). A comparison of the traffic flows for the day with the highest average flows (Fri.) with the average weekend flows (Sat. and Sun. – the days most funerals occur at Dovecot) shows that the Saturday and Sunday traffic exceeds the average Friday and 5 day and 7 day averages during the hours 10am – 5pm., with the average Sunday traffic exceeding all between the hours of 11am – 5pm).

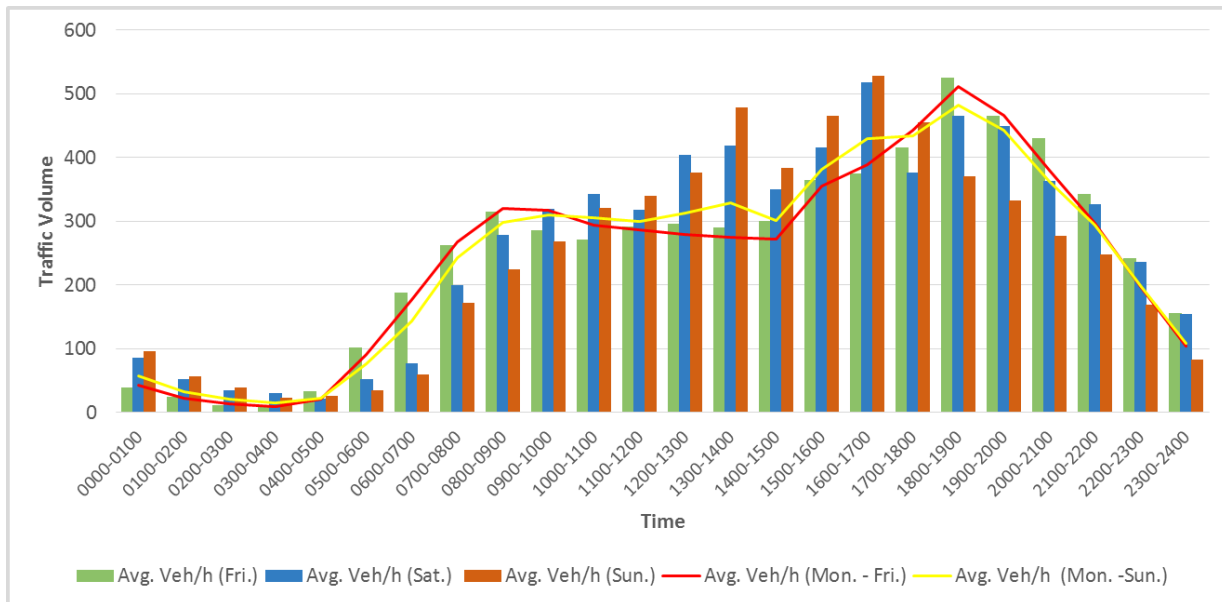

Figure 4-48 Average hourly traffic flow for west bound traffic along St. John’s road west of Featherbed Lane

The eastbound traffic (towards the Spanish Town bypass) hourly five day (Mon. – Fri.) averages of traffic flow were generally below the week (Mon. – Sun.) averages except in the mornings (4 am -11 am) (Figure 4-49). A comparison of the traffic flows for the day with the highest average flows (Fri.) with the average weekend flows (Sat. and Sun. – the days most funerals occur at Dovecot) shows that the Friday traffic exceeds the Saturday and Sunday and the 5 day and the 7 day averages during the hours 5am – 9am. only.

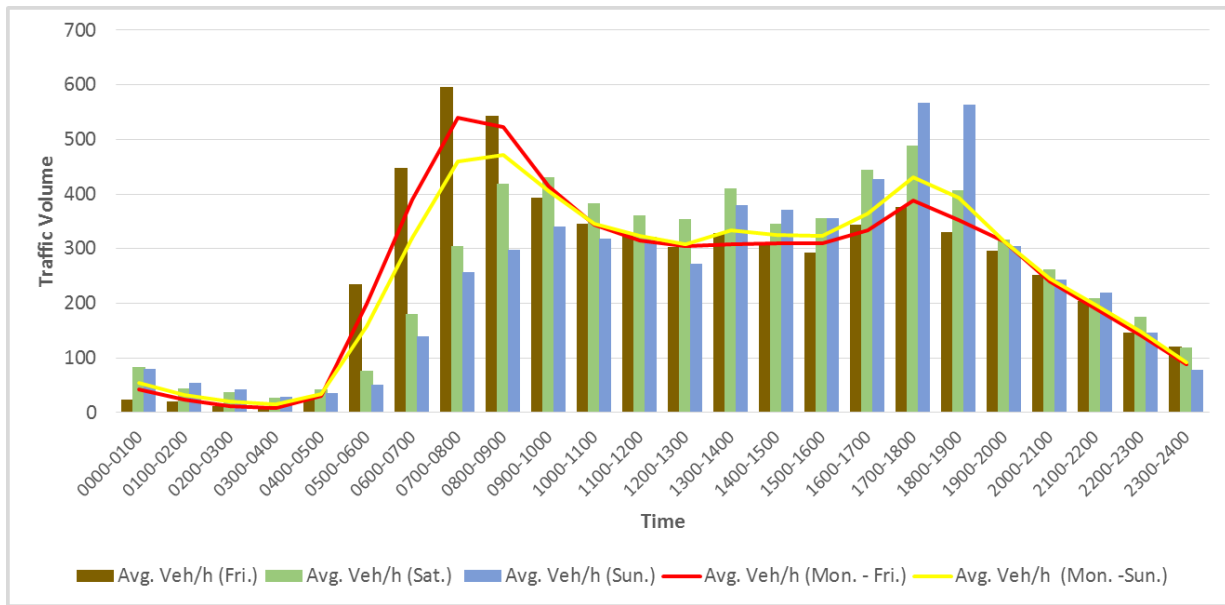

Figure 4-49 Average hourly traffic flow for east bound traffic along St. John's road west of Featherbed Lane

The Kitson Town main road traverses the southern boundary of the development area (Figure 4-50). Transportation in the area is achieved by private cars, taxis and minibuses.

It is anticipated that traffic from the proposed development will not impact negatively on the existing traffic flows, as the existing Dovecot cemetery will not be accommodating any additional burials once this expanded section is open. Therefore, we expect the traffic flows to be similar to what exists now.

**Airfields, Aerodromes and Airports**

Air transport facilities do not exist within the SIA; the closest facilities are airfields, namely Caymanas Airfield, Marlie Hill Airfield and Bog Walk Airfield, situated between 10 and 15 km from the development area. The Norman Manley International Airport (NMIA) is the closest airport, approximately 27 km southeast of the development area. The NMIA is the primary airport for business travel to and from Jamaica and for the movement of air cargo. There are 13 scheduled airlines serving many international destinations and average daily aircraft movement is 67. In 2013, total passenger movements were approximately 1.37M and freight (cargo/mail) was 11,503 metric tonnes.



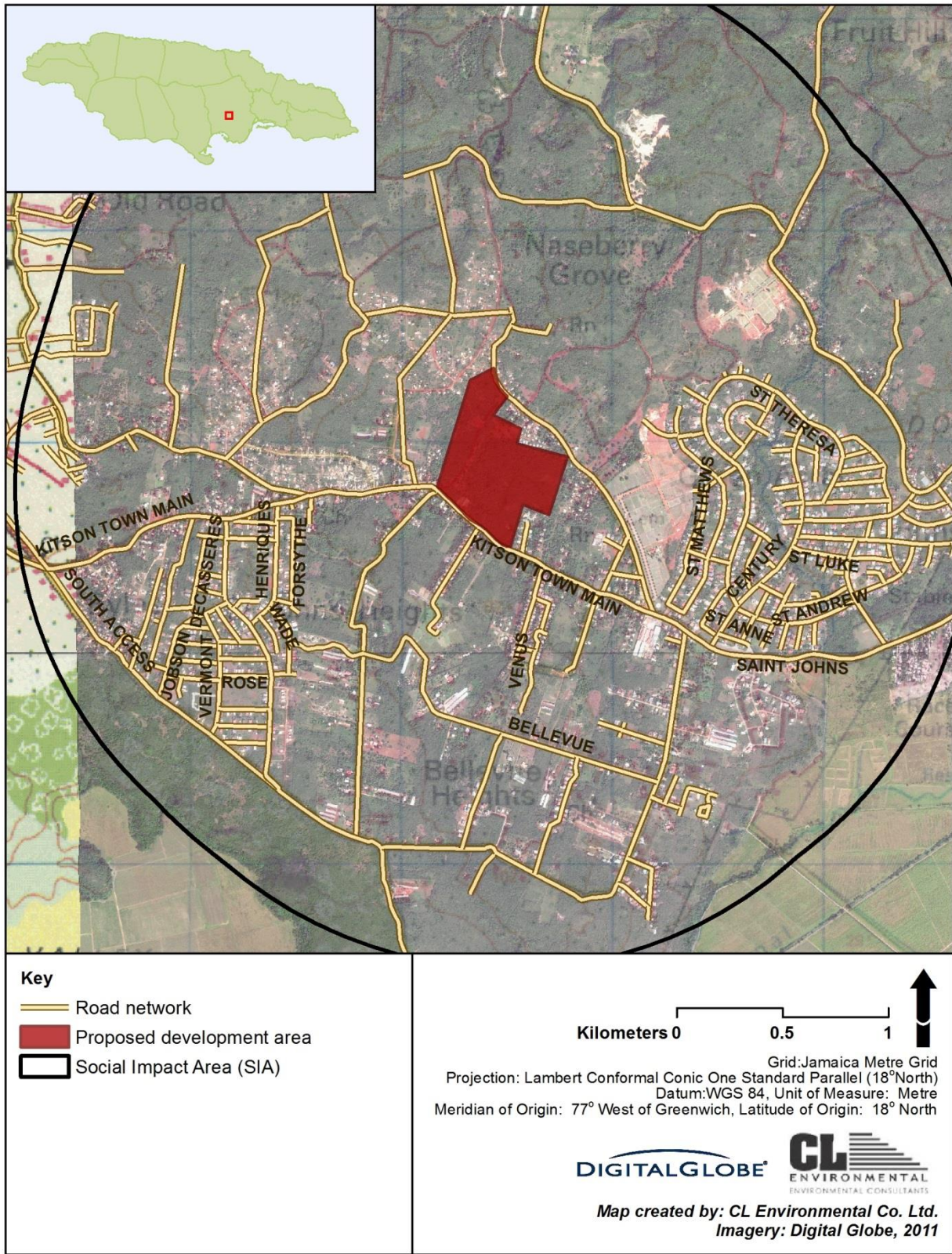

Figure 4-50 Road network and infrastructure located in the SIA



### 4.3.2 Cultural and Archaeological

The Archaeology Division of Jamaica National Heritage Trust (JNHT) conducted an Archaeological Assessment on the proposed Dovecot Cemetery expansion. The objectives of the assessment were to ascertain the presence of historical and archaeological resources and to describe these resources, along with any other socio-economic attributes and appraise their worth in context of the proposed development.

#### 4.3.2.1 Methodology

For this phase of the project a multi-faceted approach was used including documentary research and archaeological field surveys.

##### **Desk-Based Assessment**

---

All available written and graphic information relating to the area were reviewed thoroughly in order to identify the likely character, extent and relative quality of the actual or potential archaeological and architectural resources. This included relevant historical information found in the nation's repositories such as the Island Record Office, National Archives, National Library of Jamaica, University of Technology (UTECH), University of the West Indies (UWI) and private collections, and including:

- Documentation including, journals, books, maps, plans, estate accounts, correspondence, titles, deeds, etc.
- Published and unpublished results of any previous archaeological work on the site or in its vicinity.
- Satellite images and aerial photographs.

Web sites were also consulted.

##### **Field Walk Survey**

---

A Transect Linear Field Walk survey was the archaeological technique employed to identify areas of pre-historical and / or historical activities and features.

##### **Recording and Analysis of Artefacts**

---

All archaeological features, including artefacts were recorded by means of sketches, digital photographs, GPS, survey, and field notes. Where artefact assemblages were identified, samples were collected and recorded for analysis. Preliminary analysis of artefacts was undertaken in order to establish manufacture location and cultural association. Individuals familiar with the site were also interviewed and this information noted to add to the data base on sites.

#### 4.3.2.2 Results

### Desk-Based Assessment

The cemetery will be built on the property now known as Bendon Pen. In 1763 the area was located in the parish of St. John (Figure 4-51) and the Craskell and Simpson map of 1763 shows some settlement in the area (Figure 4-52).

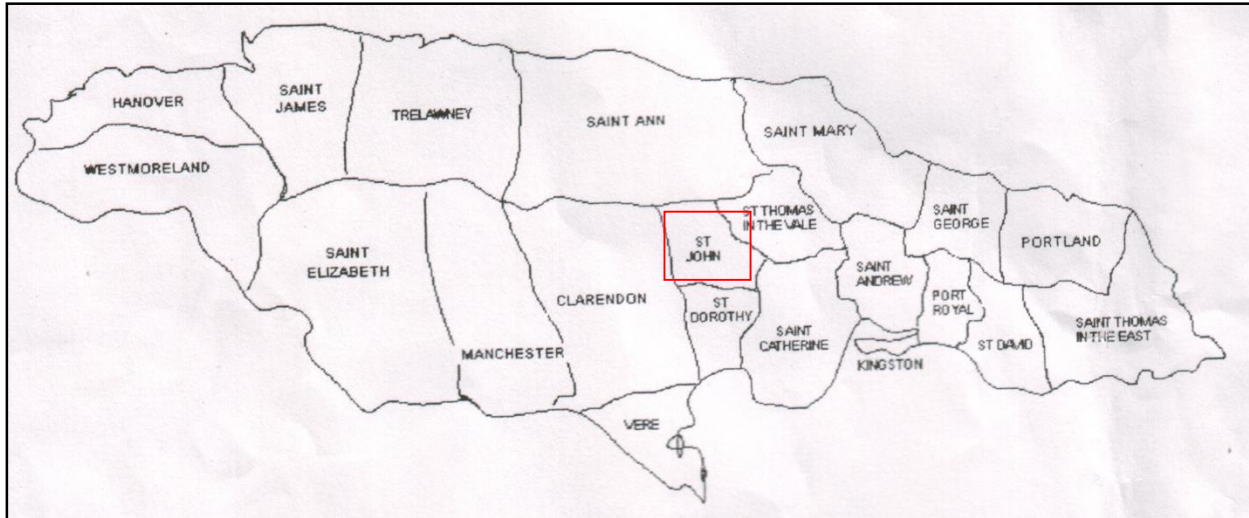

Figure 4-51 The Island of Jamaica in 1814-1840 with St. John parish outlined in red



Figure 4-52 Historic 1763 map showing settlement in the proposed development area

However, by 1804 the property was known as Chisholm's as seen on James Robertson's map of 1804 (Figure 4-53). Eventually Chisholm was divided into Naseberry Grove, Mount Hazard and Bendon Rest. By 1881 there was further subdivision with lands sold to small settlers (Figure 4-54).

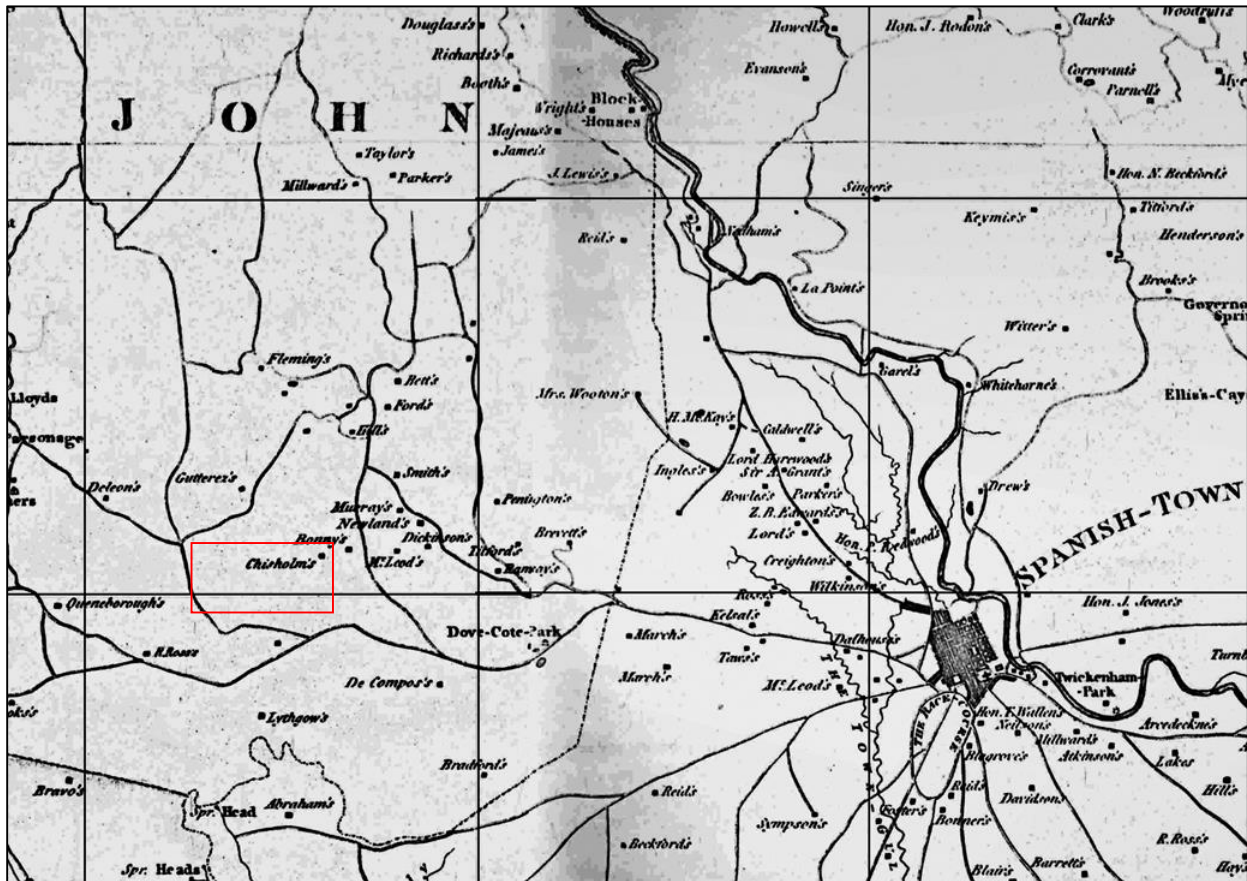

Figure 4-53 Historic map of 1804 showing location of Chisholm's







Plate 4-6 Vegetation cover of the area



Plate 4-7 Two (of many) paths found within the proposed area of development

A number of Taino pottery shards were collected within the area on the surface (Plate 4-8). The cemetery site falls within the vicinity of the Red Hills Taino site mentioned as early as 1707 A.D by Sir Hans Sloane.





Plate 4-8 Piece of Taino pottery shard in situ in burnt out charcoal kiln

The wood used in the production of charcoal is from young immature trees. Consequently, except for the mangoes and cashew trees, there are no mature trees present in the area.

During the survey some of the boundary markers were noted. There are modern structures that abut the line in some places. These may be affected by the development (Plate 4-9).





Plate 4-9 Boundary markers

The foundations of several structures were seen throughout the site. According to Mr. Howell the site had contained several dwellings. The floors of two of the most recently demolished were photographed (Plate 4-10). These two buildings were identified by a resident as a shop and a dwelling house which were pulled down after word came that Dovecot had purchased the land.





Plate 4-10 Foundations of recently demolished structures

A number of bricks were found in the area where the stable once stood (Plate 4-11). These stables are outlined in yellow on the Harrison map of 1881 (Figure 4-55).



Plate 4-11 Bricks in the vicinity of historic stable



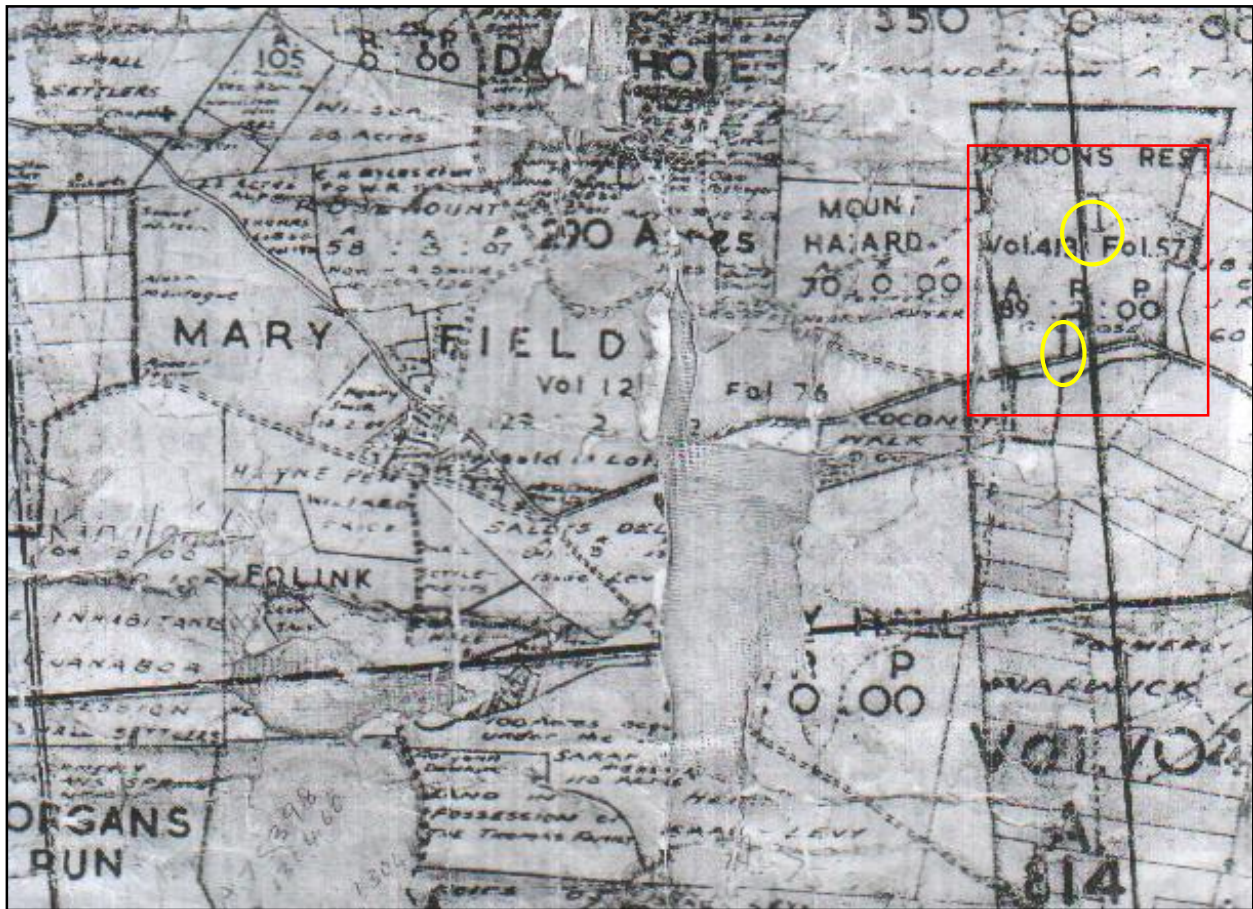

Figure 4-55 Harrison Map showing locations of stables outlined in yellow

A graveyard was identified at grid reference 18Q 0285688, 1992735. Two unmarked concrete tombs were identified along with a fairly large assemblage of bricks (Plate 4-12). These bricks are believed to be the remains of several other graves dating from an earlier period but were destroyed by the roots of large mango, calabash and fig trees. A detached headstone was found among the graves, it was inscribed to J. Nathan Peak who passed away in the 1950s. It is interesting to note that one J.R. Peeke owned the neighbouring 60 acres to Bendon Rest in 1821 (Figure 4-56).





Plate 4-12 Tombs and headstone found in graveyard

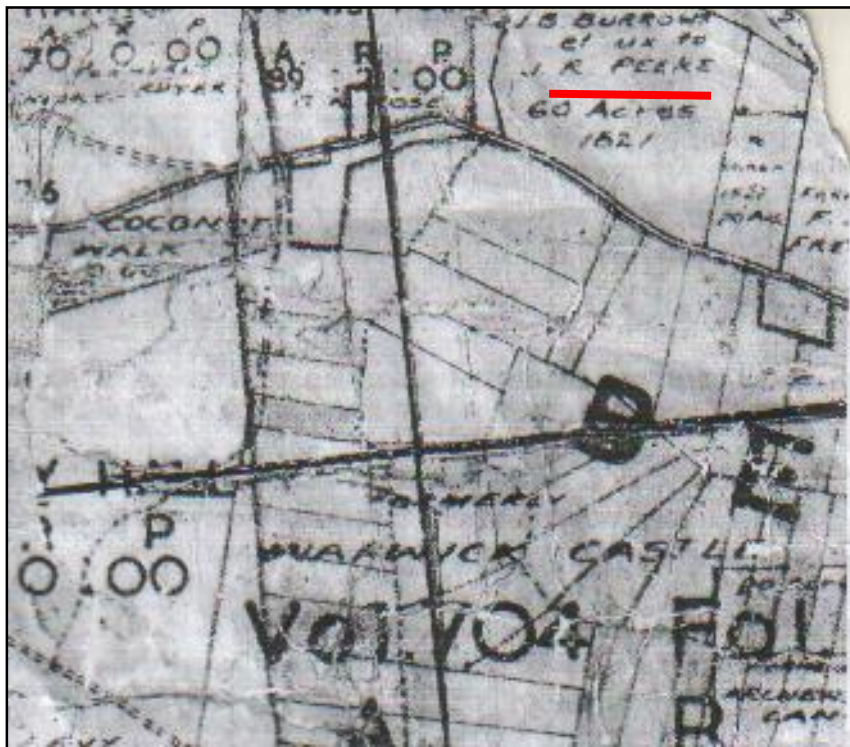

Figure 4-56 Extract of Harrison Map Showing J. R .Peeke owning lands abutting Bendon Pen

Three water troughs were found at various points indicative of cattle and horse rearing in the past. These features were located at grid reference points 18 Q 0285773, 1992423, 18 Q 0285793, 1992401 and 18 Q 0285608, 1992728.



Plate 4-13 Trough (one of) that was found in the proposed development area

### Find Inventory

The main objective of the finds inventory was to ascertain the number and variety of artefacts collected, and to assign a date range for the site. The inventory exercise revealed the presence of three main material types, namely, clay, glass and metal. The material types were further subdivided into ware groups. The total number of pieces collected from this site was twenty-six pieces. These pieces can be divided into three periods; prehistoric, historic and modern.

Artefacts are important analytical tools used by the archaeologists in a variety of ways. When found in context they can tell of the occupants' lifestyle. For example, animal bones can reveal consumption pattern, and butchering practices; ceramics, glass and smoking pipes are used as dating tools as well as providing other information. Bricks and nails tell of the architecture of a period. Bricks can also tell of the ethnicity of the builder. Shells can indicate type of food sourced by the occupants of a site. Ceramics and glass tell of storage and consumption patterns and can also indicate trading patterns. Pharmaceutical bottles are indicative of medicinal practices.

It should be noted that some cultural items made of perishable material for example; calabashes, baskets and clothing do not survive in humid conditions hence their absence from the archaeological record. It must also be noted that artefacts are mostly recovered as shards.

Plate 4-18 through to Plate 4-24 showcase artefacts found on site. The time period of the artefacts ranges from 650 AD to the 20<sup>th</sup> century.





Plate 4-14 Bowl Shards, Earthenware Taíno, 650-1500 A.D



Plate 4-15 Bowl Shards, Earthenware African Jamaican, 1670-1835 A.D



Plate 4-16 Bottle Shard, Brown Salt glazed Stoneware, English, 1720 -1800 A.D



Plate 4-17 Cylindrical wine bottle shard, Olive Green Glass, English, 1735-1830 A.D



Plate 4-18 3 piece mould Cylindrical wine bottle shard, Olive Green, English, 1749-1840 A.D



Plate 4-19 Bowl shards, Cream ware, English, 1762-1820 A.D



Plate 4-20 Cooking pot shard, Iron African-Jamaican, 18th -19th C



Plate 4-21 Pharmaceutical Bottle Hors Indian Root Pill, Brown Glass, Jamaican, 20th C



Plate 4-22 Flower Pot shard, Earthenware, African Jamaican, 20th C



Plate 4-23 Floor Tile, Earthenware, 20th C



Plate 4-24 Figurine handle shard, Porcelain, 20th C

### **4.3.2.3 Discussion and Conclusion**

The area that was surveyed was heavily forested primarily with young trees and shrubs. Though not fully matured a number of trees have been chopped down and used in the making of charcoal. Some trees such as naseberry, cashew and sweetsop suggest that the Taino occupied the site. This was confirmed by the presence of Taino pottery shard observed on surface.

Numerous footpaths traverse the property leading to mango trees, charcoal kilns and small cultivated plots. Most of these paths are used as short cuts from the St John's - Kitson Town main road to the small contiguous settlements.

Due to dense vegetation cover and foliage, artefacts assemblage on the surface was not easily detected. Some areas were not accessible due to the dense vegetation cover. According to Sir Hans Sloane (1707) significant Taino presence were detected in the vicinity of the site.

## **4.3.3 Land Use and Zoning**

### **4.3.3.1 Past Land Use**

As reported by JNHT, evidence suggests that the Taino may have occupied the area planting their staple food crops and fruit trees; the numerous naseberry, cashew and sweetsop trees gives credence to this. Desk based assessments revealed that the property was used as a cattle pen in the 19<sup>th</sup> century and for the rearing of race horses in the 20<sup>th</sup> century. In the latter part of the 20<sup>th</sup> century, a number of persons set up residences on the land.

### **4.3.3.2 Current Land Use**

Land use within the wider SIA is a mixture of buildings and other infrastructure; fields including herbaceous crops, fallow and cultivated vegetables and secondary forest (Figure 4-57). The land use is mostly residential with other activities include commercial activities (e.g. shops, hardware stores), agricultural and cemeteries.

At the proposed site, most of the land is in ruinate. It is divided in two by one drivable road running across the site from the Kitson Town main road in a north easterly direction. The road serves as vehicular access to communities bordering the study area. The area also consists of numerous trails which are used to commute to and from communities which surround the site and to access the resources within the study site.

Informal settlers exist on the property, as well as the extant Bendon Seventh Day Adventist (but will not be affected) (Plate 4-25). Economic activities include charcoal burning, as evidenced by numerous coal kilns on the site (Plate 4-26). Fruit harvesting is another economic activity; along the boundary, especially in the vicinity of the adjoining settlements, some squatters cultivate banana, sweet potato, corn, pepper, carrot, cassava and gungo peas. Wood is gathered for cooking and construction material. The diversity of shrub, herbs and weeds provide plants are used for medicinal purposes. Residents on site and within the surrounding communities also use the area for the grazing of animals and as garbage disposal (Plate 4-27).





Plate 4-25 Bendon Seventh Day Adventist Church



Plate 4-26 Area cleared of all vegetation for use as coal kiln. Bottom right- A stack of the typical size stems used for charcoal production in this area.

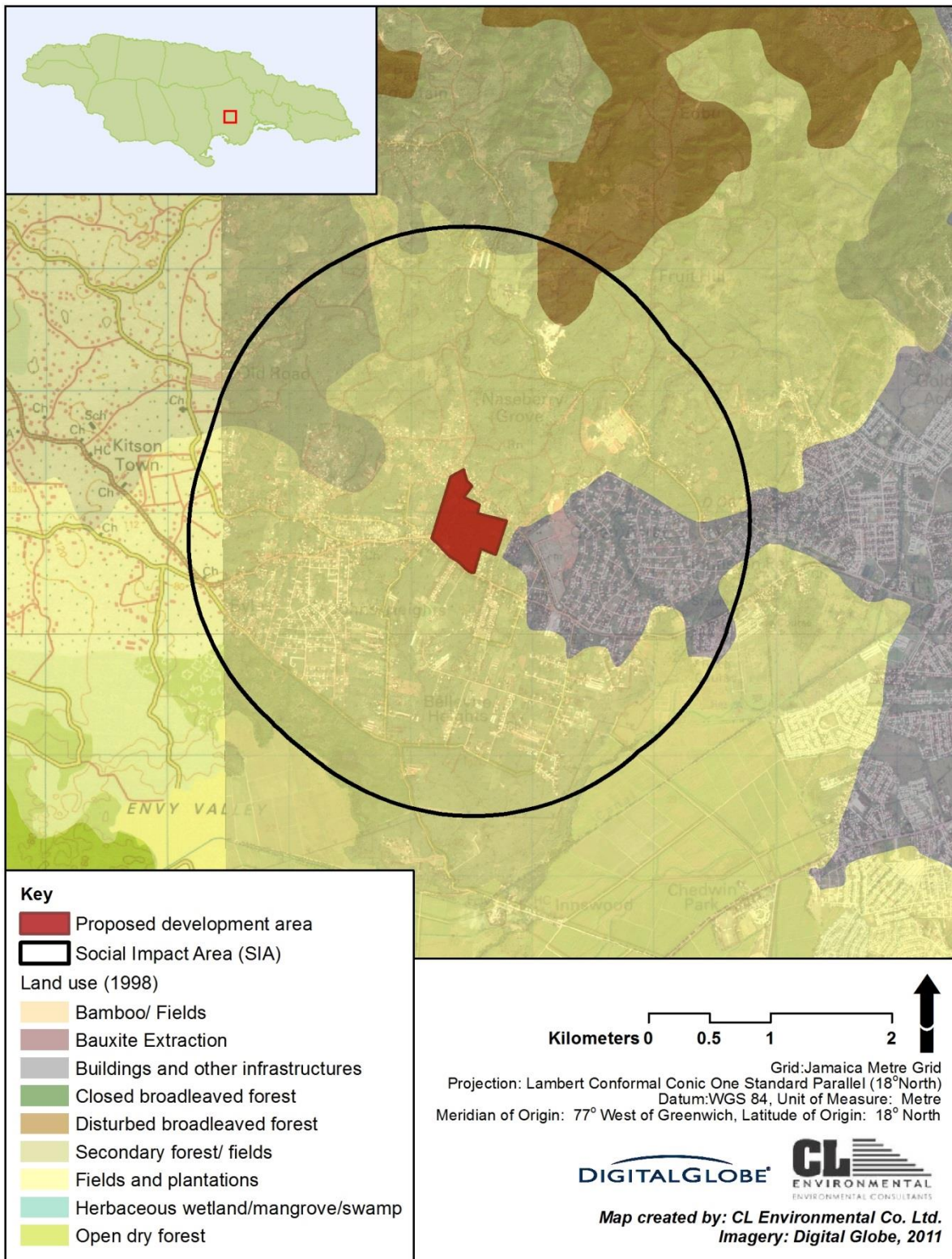



Plate 4-27 Disposal of garbage on proposed property

#### 4.3.3.3 Protected Areas and Zoning

The proposed development area and SIA do not fall within any area protected by law. Also, as seen in Figure 4-58, the proposed project does not fall within the St Catherine Coastal Development Order boundary, however about 3 km north of it. Another important zonation map to be considered is that arising from the development of Highway 2000 - 'Portmore to Clarendon Park Highway 2000 Corridor Development Plan 2004 - 2025'. This plan was developed by the Government of Jamaica to guide development along the H2K corridor and may be seen Figure 4-59. The proposed project area however does not fall within any area zoned by this plan.



Data source: Forestry Department (1998)

Figure 4-57 Land use within the SIA



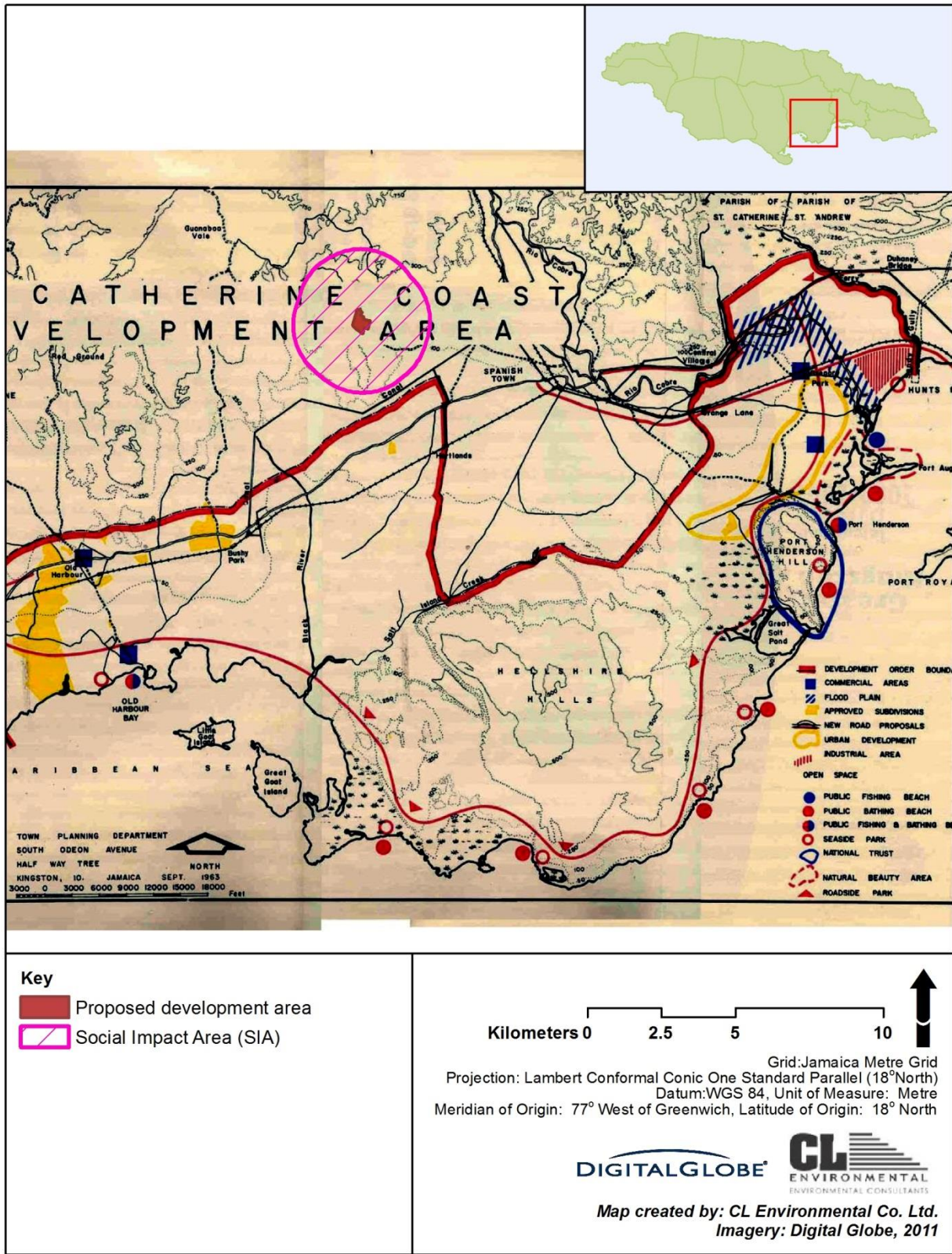

Figure 4-58 St Catherine Coastal Development Order map



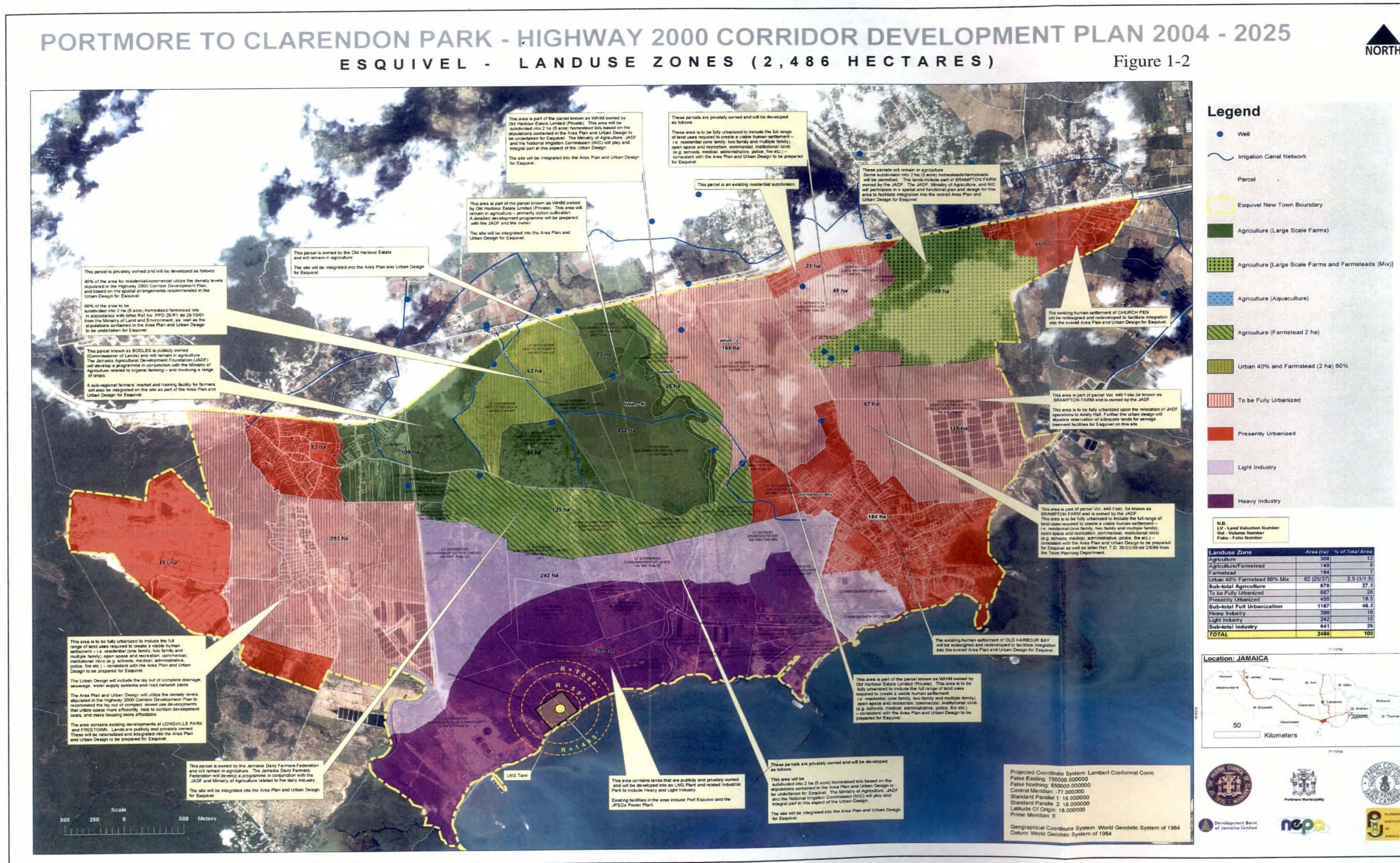

Figure 4-59 - Map showing Land Use of Highway 2000 Corridor Development (Portmore to Clarendon Park)



#### 4.3.4 Aesthetics

The land of the proposed site consists of highly disturbed vegetation dominated by shrubs and saplings. There are also cleared and burnt out sections of the land being used for coal kilns and other sections being used for informal dumping solid waste (see Plate 4-27).

The proposed development will involve the clearing of sections of the existing vegetation, access roads will be built and the area landscaped (Figure 4-60). It will involve grassing and the planting of shade trees. Some of the vegetation that will be used in the landscaping are; Red Birch, Guango and Hibiscus plants.

The shade tree, hedges and manicured lawns will enhance the aesthetics of the site.

A viewshed analysis was conducted using observation points from Green Acres, Mercury Gardens, Naseberry Grove, Bendon and St Johns Heights. The observer was set at a height of 1.8m above ground level and 4.6m to simulate standing on a second floor balcony.

The results indicated that there was a partial view of the proposed development from Green Acres (most areas seen), partial view from Mercury Gardens ( $\approx$  50%), partial view from Naseberry Grove (40% - ground floor & 98% second floor) and no views from Bendon and St. Johns Heights.

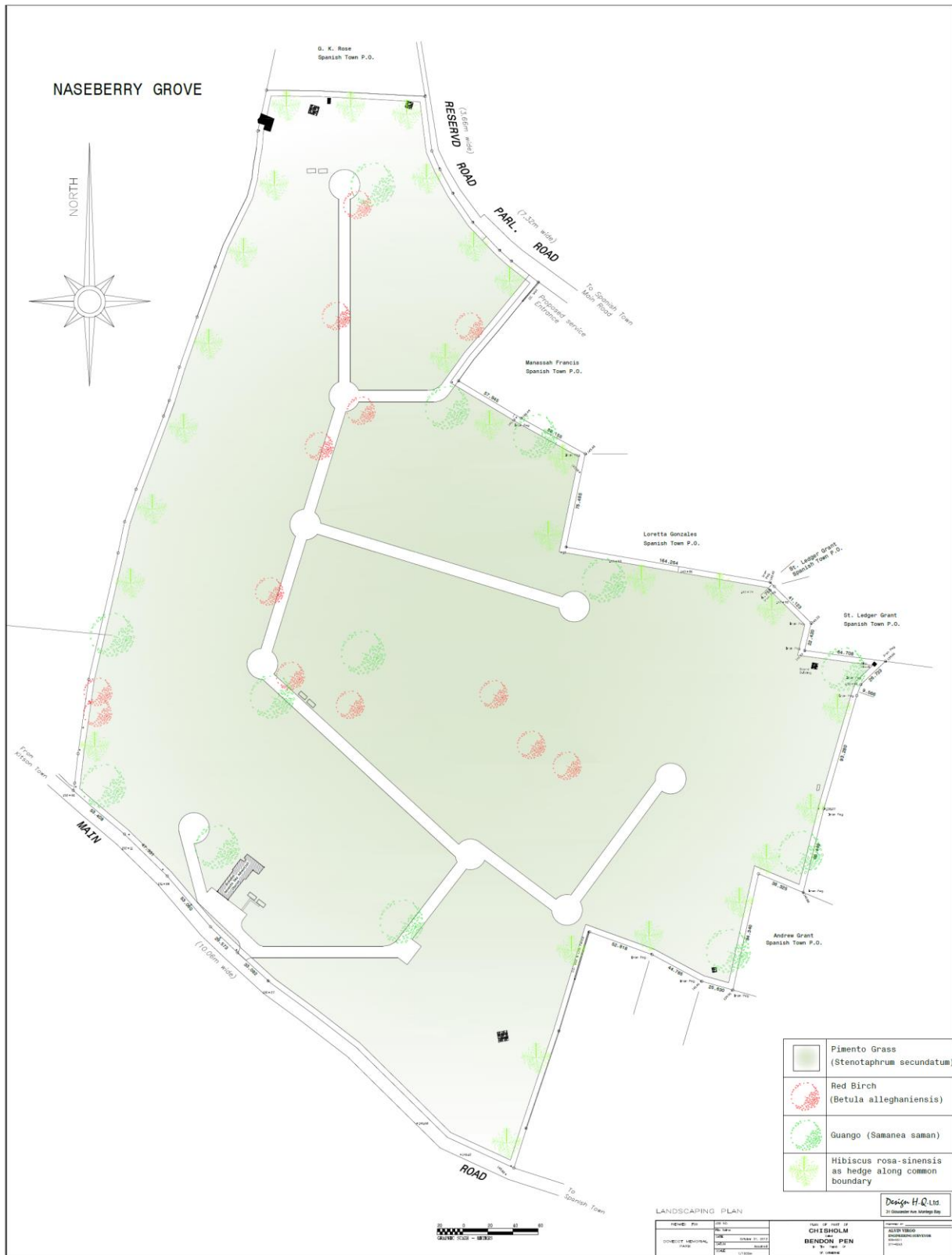

Figure 4-60 Proposed landscape plan for the Dovecot cemetery expansion



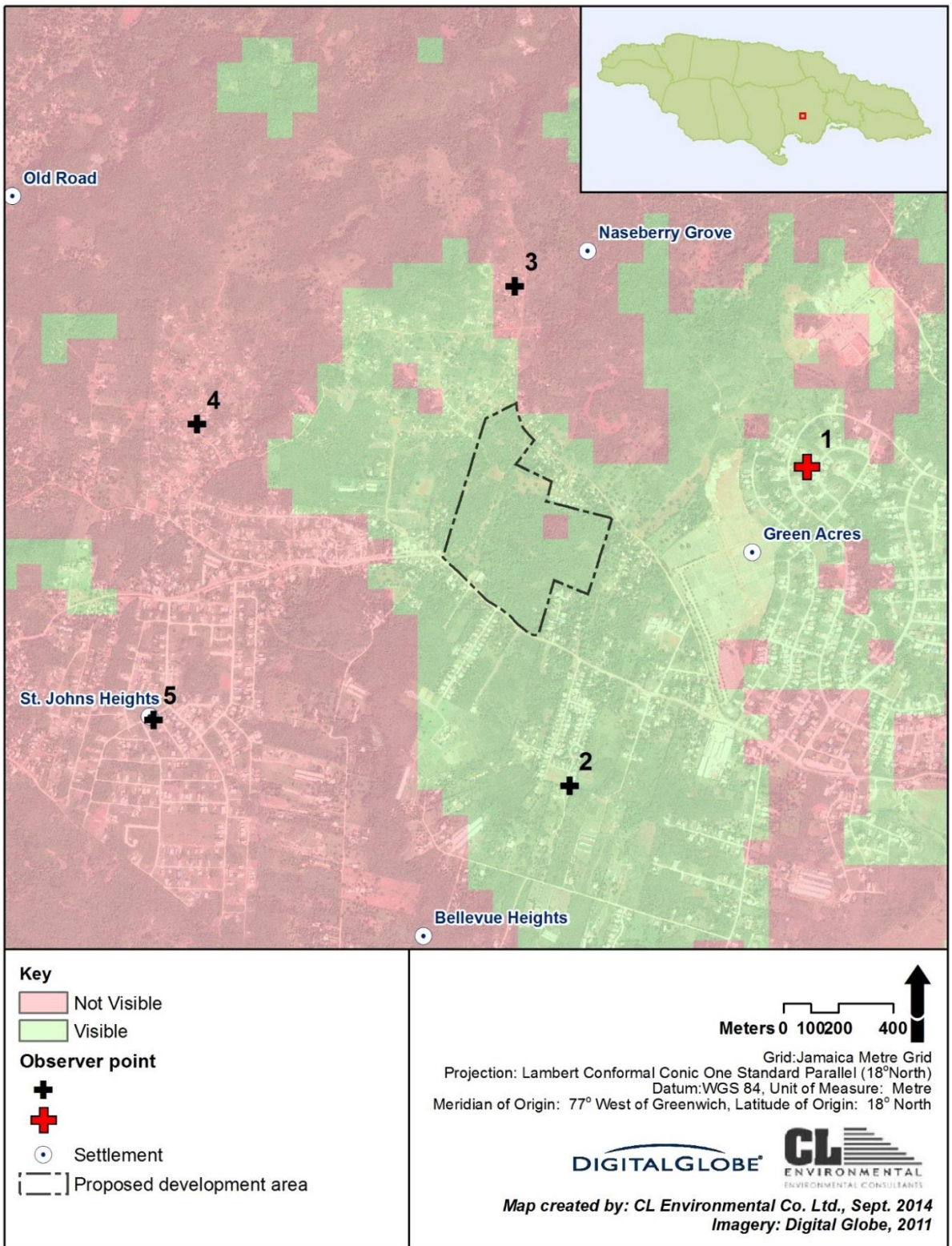
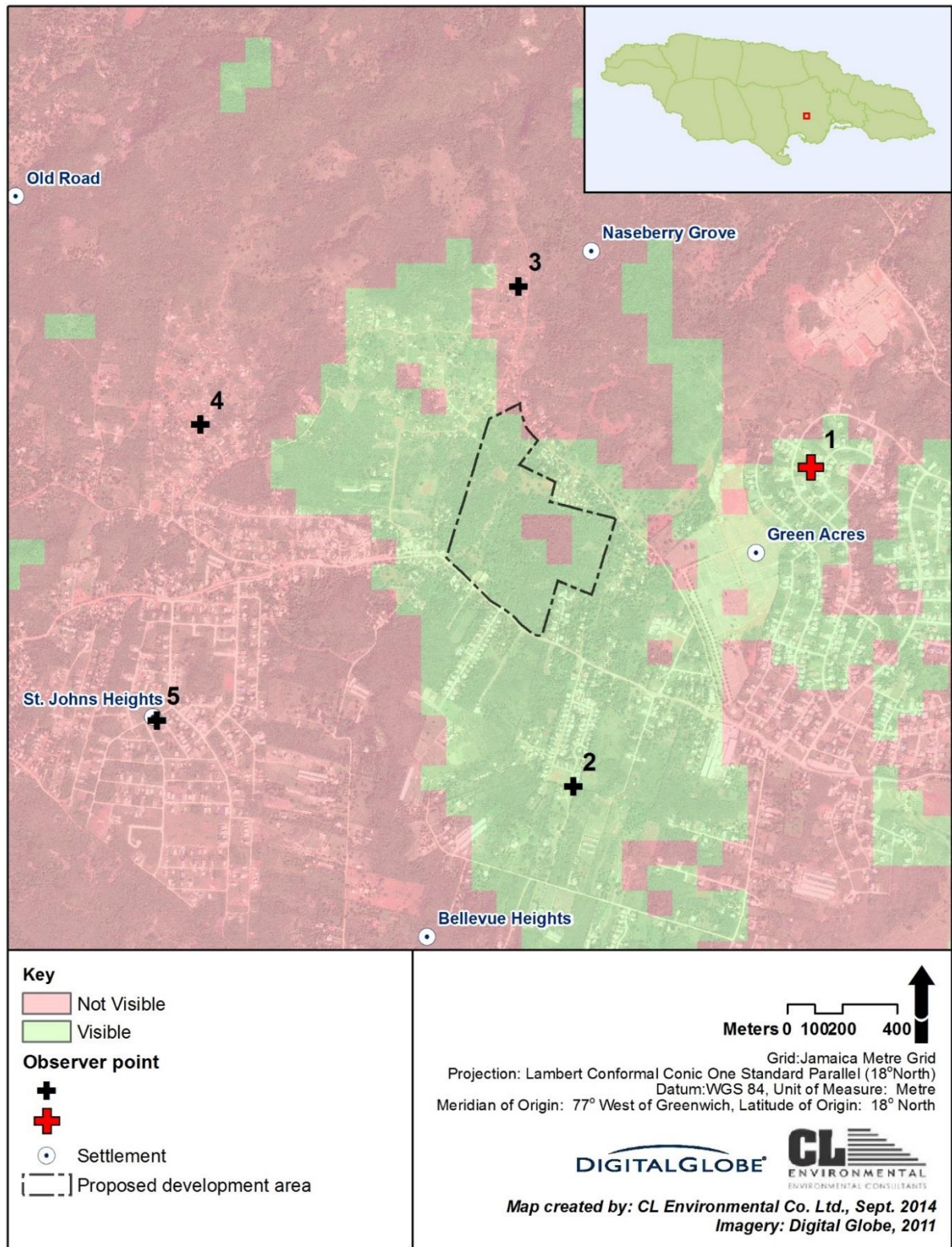

Figure 4-61 Viewshed from Green Acres from the ground floor (left) and on the second floor (right)



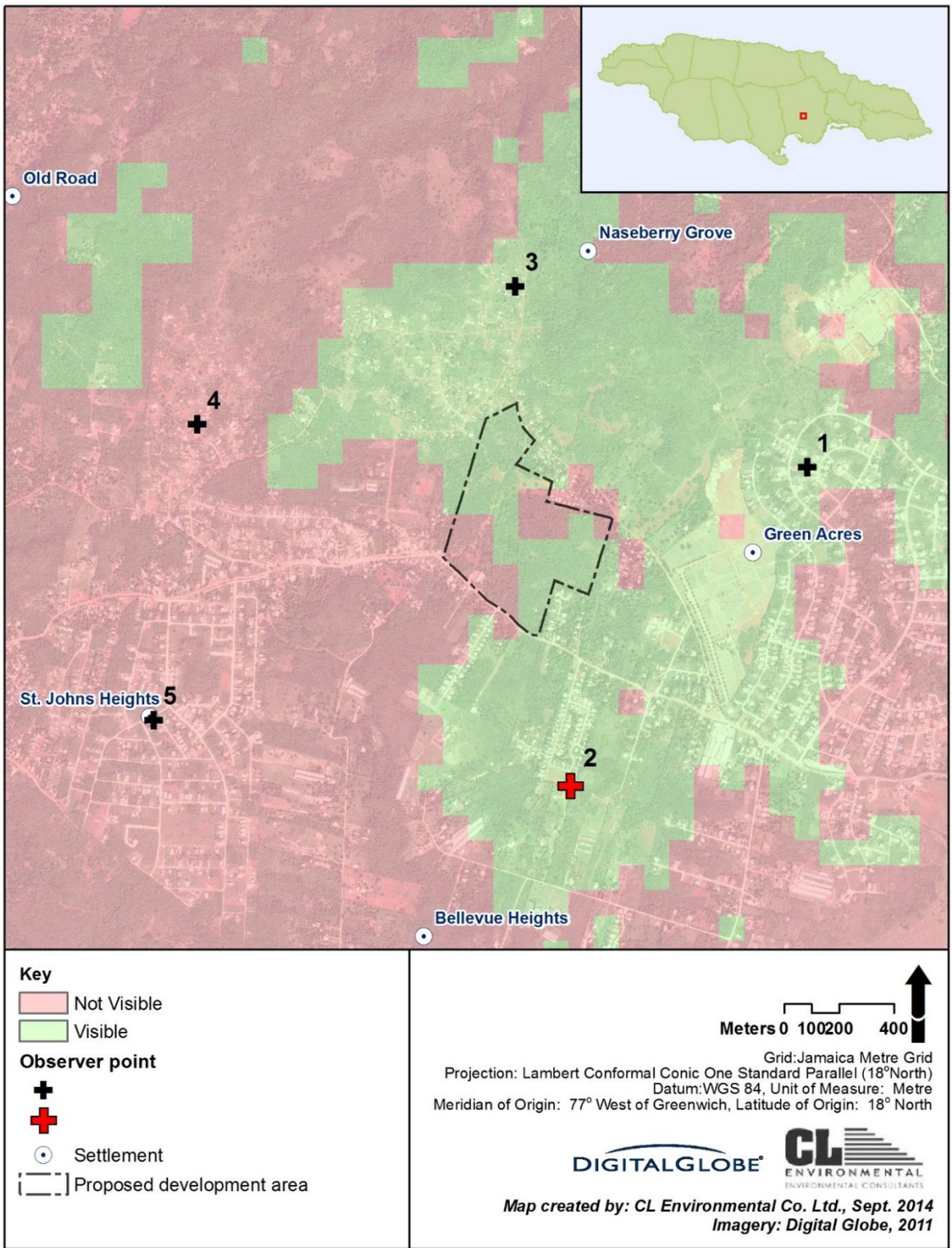
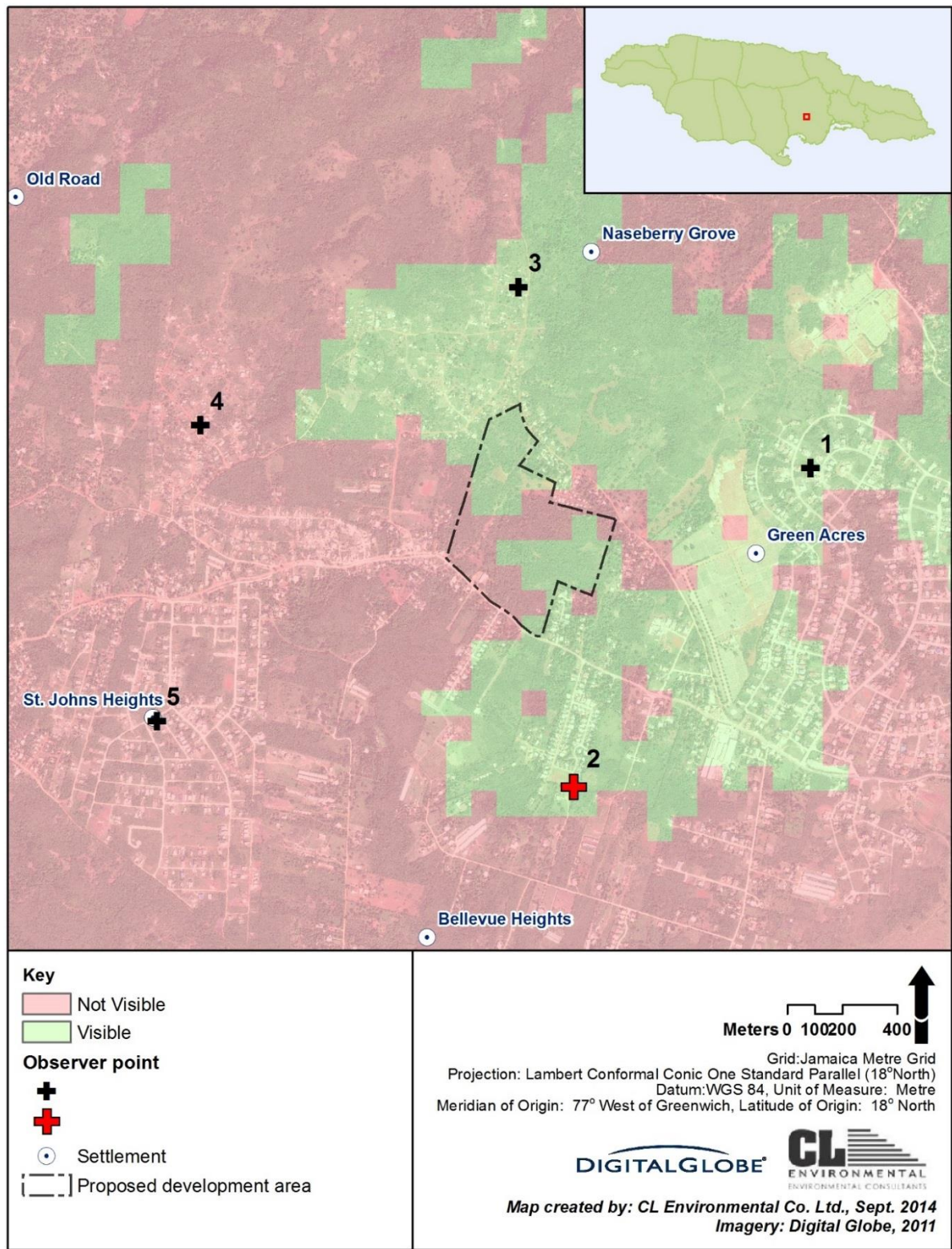

Figure 4-62 Viewshed from Mercury Gardens from the ground floor (left) and on the second floor (right)



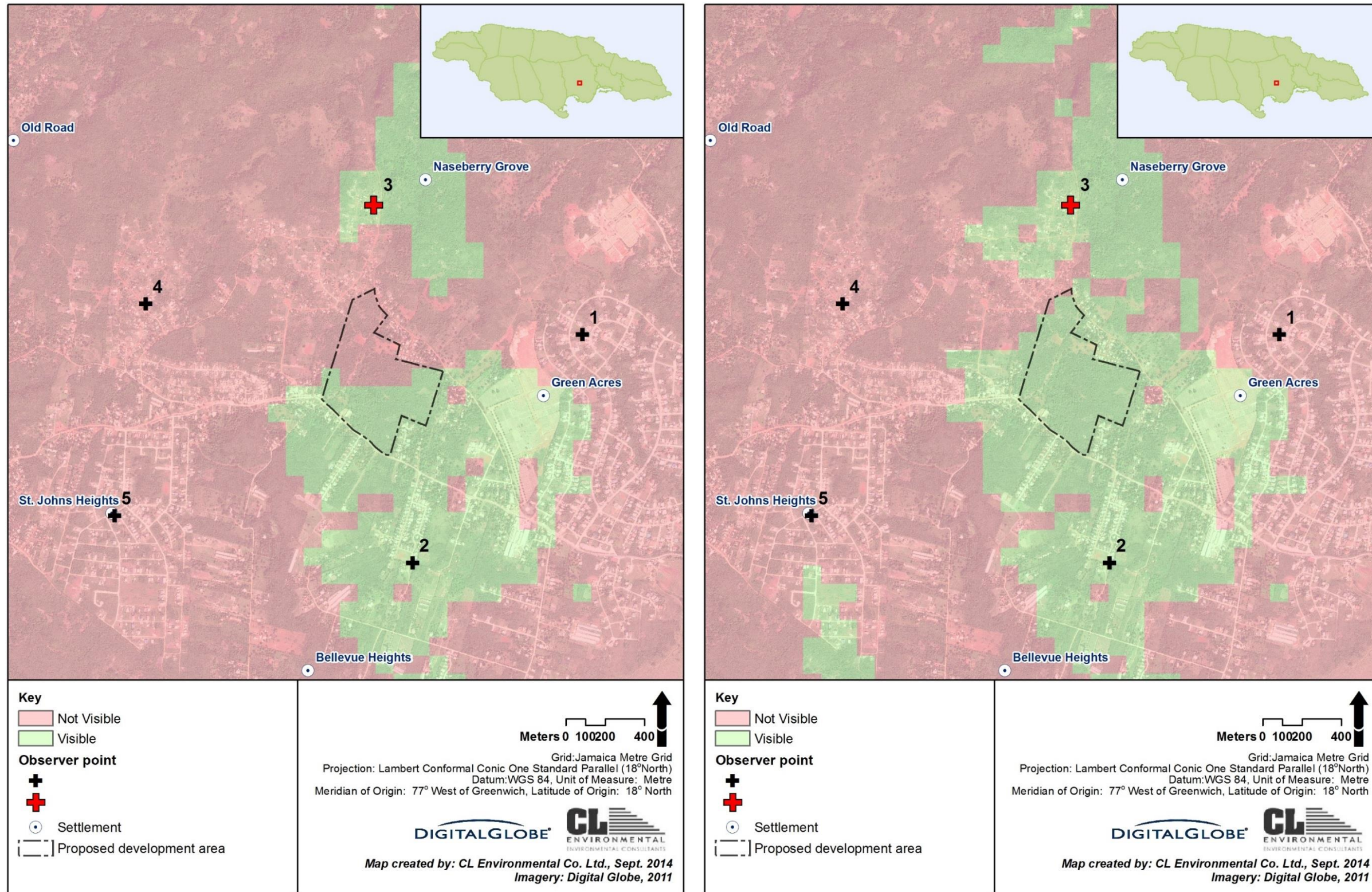

Figure 4-63 Viewshed from Naseberry Grove from the ground floor (left) and on the second floor (right)



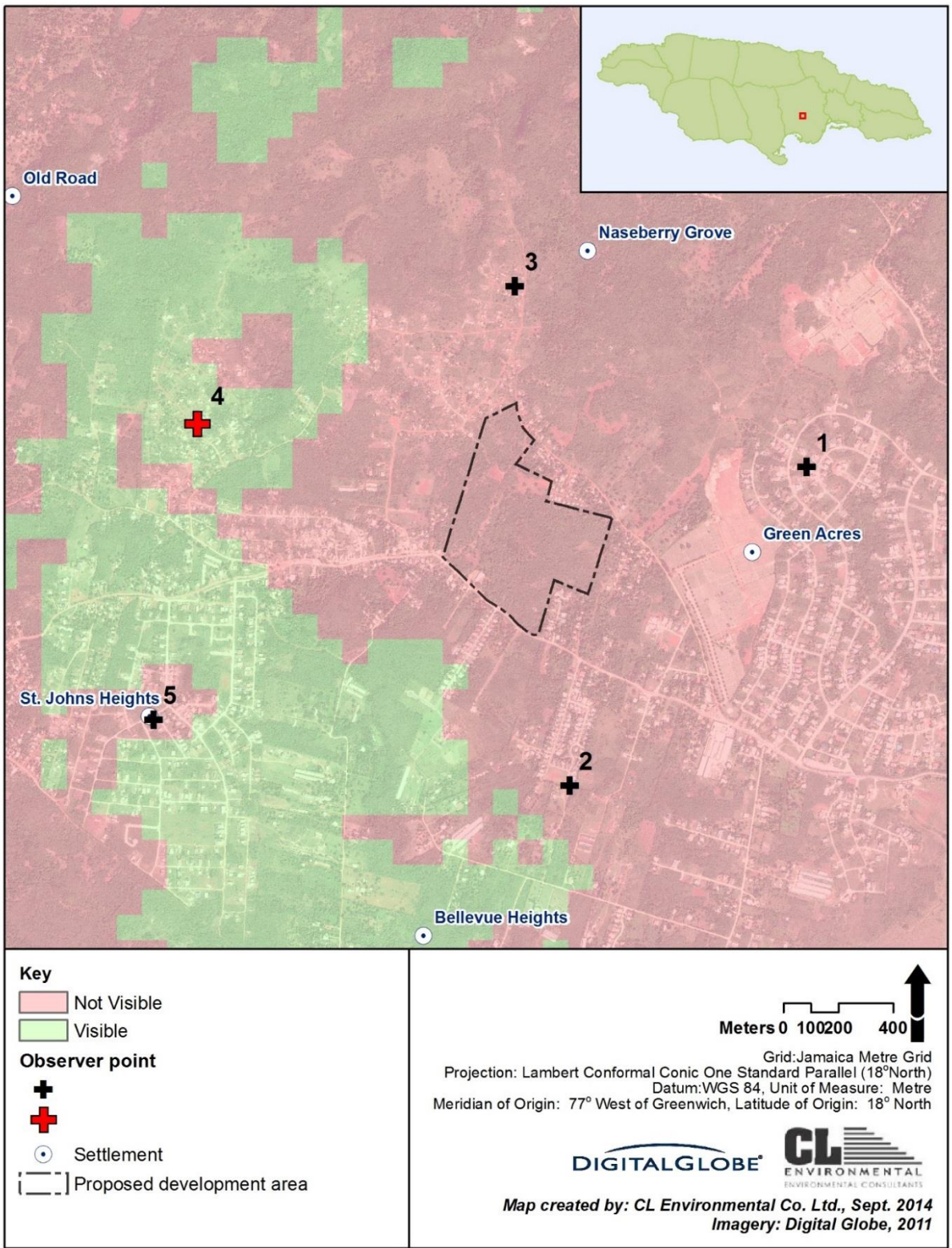
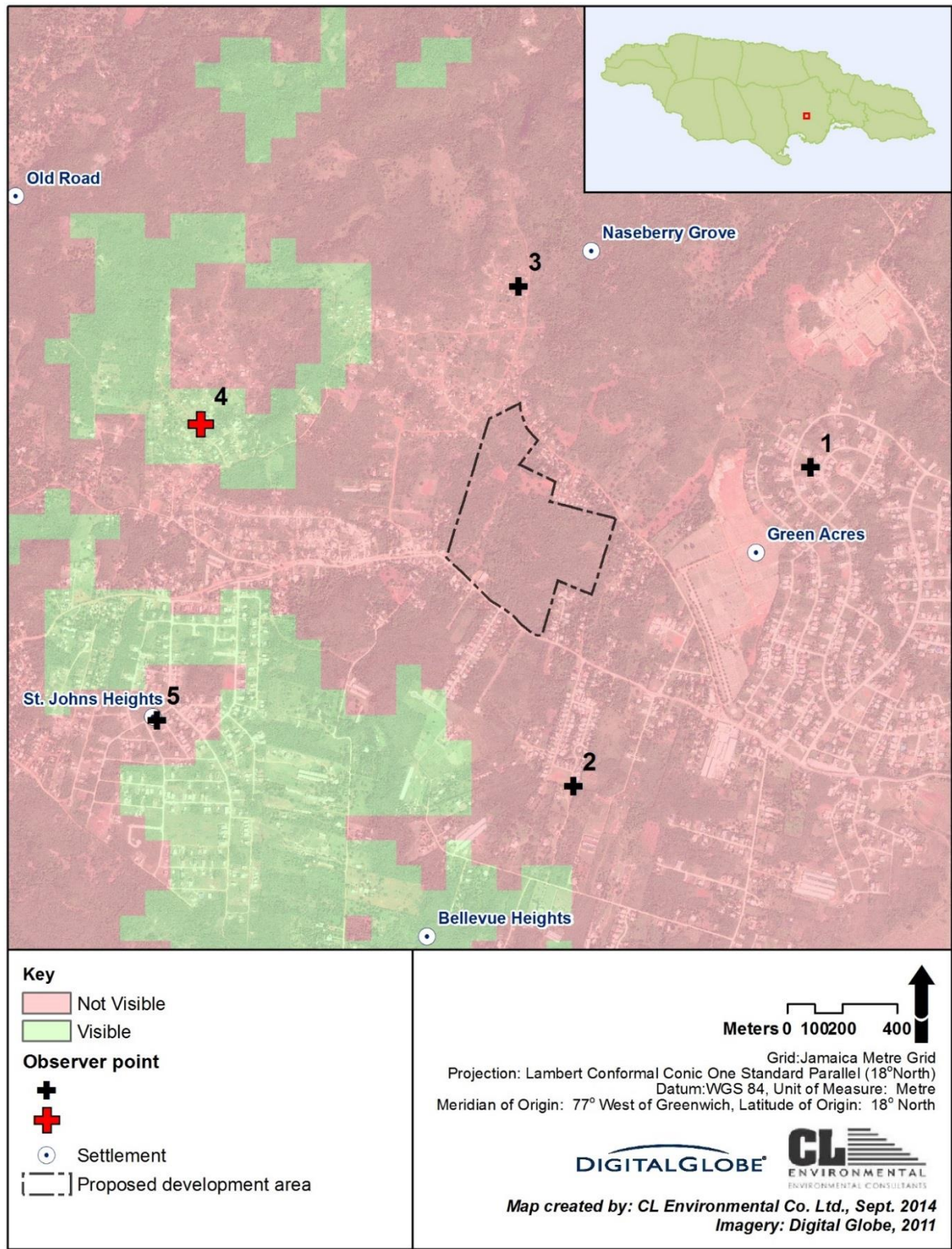

Figure 4-64 Viewshed from Bendon from the ground floor (left) and on the second floor (right)



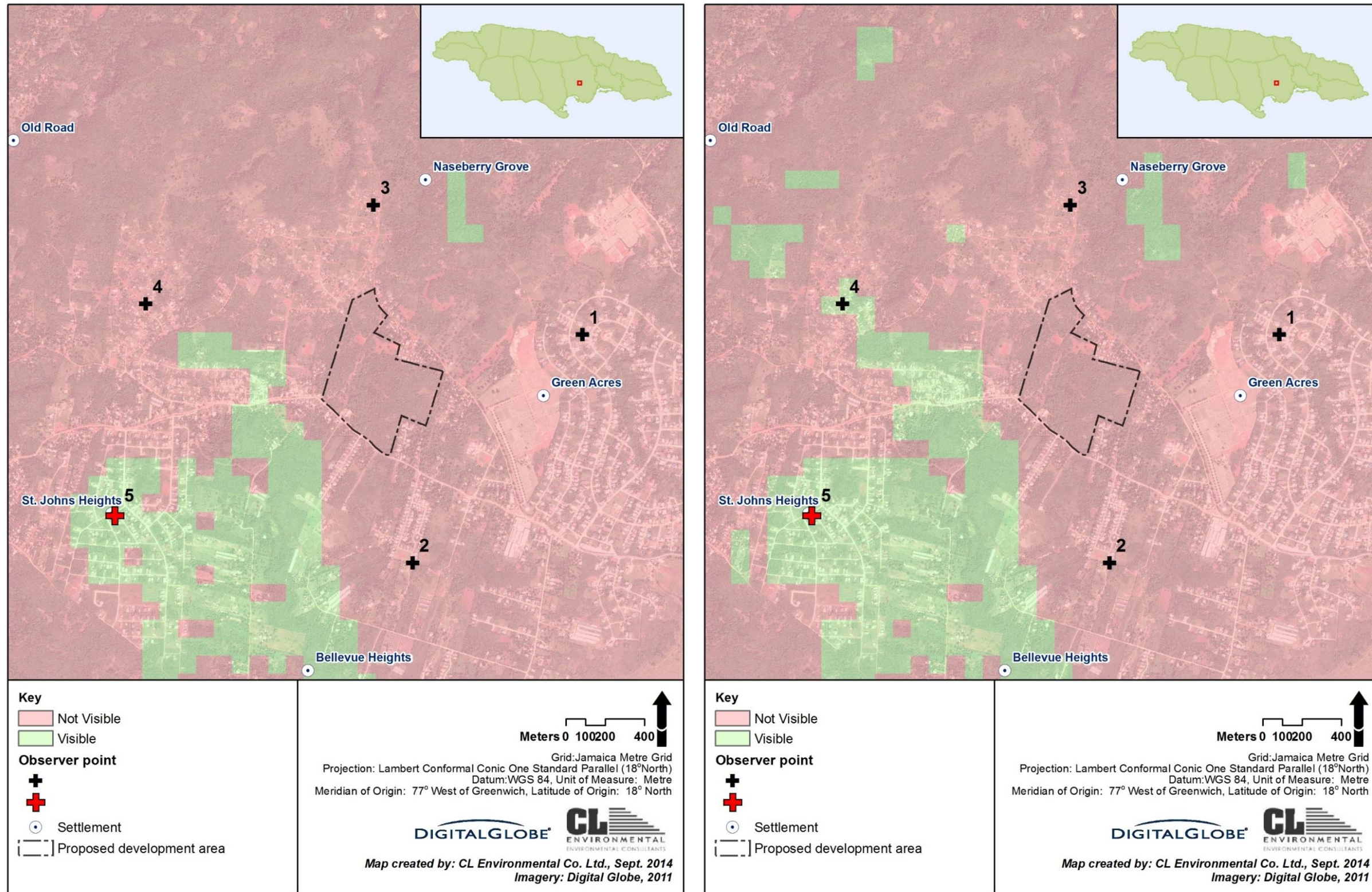

Figure 4-65 Viewshed from St. Johns Heights from the ground floor (left) and on the second floor (right)

## 5.0 PUBLIC PARTICIPATION AND CONSULTATION

### 5.1 PURPOSE OF THIS SECTION OF THE EIA

This section outlines the stakeholder consultation programme for this EIA process and summarizes the key stakeholder issues arising to date.

### 5.2 STAKEHOLDER CONSULTATION PROGRAMME

Stakeholder consultation during the course of this EIA includes the following mechanisms.

1. Perception Survey conducted within communities two (2) kilometres of the proposed development area. Eleven main communities were visited. These communities were Naseberry Grove, Dovecot, Mercury Gardens, Taylor Road, Bellevue Heights, Green Acres, Byles, Bendon, St Johns Heights, St Johns Meadows and Bellevue (Figure 4-38).

The Perception Survey questionnaire (Appendix 7) administered addressed the following major issues:

- a. General acceptability of the proposed project by community-based stakeholders.
  - b. Fears and expectations about the specific project, including any anticipated social conflict and crime.
  - c. Perceptions and attitudes of the community.
  - d. General health, safety and environmental concerns related to the project
2. Other stakeholders
    - a. Water Resources Authority (WRA),
    - b. St Catherine Parish Council (telephone - Mr Davio Robinson),
    - c. National Works Agency (NWA) (telephone – Mr Ray Parchment),
    - d. St. Catherine Health Department Ministry of Health (telephone – Inspector Richard Baker); and
    - e. Jamaica National Heritage Trust (JNHT)
3. Public Presentation
    - a. A public presentation outlining the project, environmental impacts, and proposed mitigations main findings of the EIA will be held at a community-based meeting. The meeting will be held in conformance with the NEPA Guidelines for Conducting Public Presentations (Appendix 3). The key points are:
      - i. The Public Meeting shall not be held less than 21 days after the EIA is made available for public review; and



- ii. The public has one (1) month after the public meeting to submit written responses/comments.
- b. The continued availability of all EIA documentation for public review until a decision is made in respect of the development application. This includes:
  - i. The approved Terms of Reference (appended in the EIA),
  - ii. The EIA inclusive of all supporting technical appendices; and
  - iii. The verbatim minutes of the Public Meeting (including the register of attendance).

## 5.3 ISSUES RAISED

### 5.3.1 Community Stakeholders

The main issues raised by the community stakeholders were:

1. Proximity of the proposed cemetery to residential areas/residence.
2. Possible depreciation of property values
3. Flooding in communities and along Taylor Road during heavy rains.
4. Increased traffic congestion (especially on weekends)
5. Increased difficulty to commute via public transportation especially by taxis
6. Lack of water supply
7. Poor road conditions
8. The need for the cemetery to be fenced
9. Foul odour from cremation done at the current Dovecot (comments from Bellevue Heights residents)
10. Possible water contamination
11. Possible spreading of contagious illnesses transmitted post-mortem
12. The land should be used alternatively as either for schools, housing or church
13. Potential increase in fugitive dust and noise levels in the area
14. Possibility of job creation
15. Crime in the area; and
16. Impact on aesthetics

### 5.3.2 Other Stakeholders

#### 5.3.2.1 Water Resources Authority

The WRA prepared a Technical Note (September 23, 2014). This is included in Appendix 6. In this note the WRA indicated that:

- a) Groundwater: The estimated depth to groundwater where the proposed cemetery will be developed is fairly shallow (21.71m – 60.76m BGL). The limestone aquifer

is tapped by NWC and various business entities for public supply as well as irrigation purposes for the agricultural lands located south of the site. Additionally, the groundwater from this region is important for recharge to the springs and streams south of the site.

- b) Due to the karst development and the fact that the soil overburden displays very rapid internal drainage there may be increased risk of contaminants reaching the water table. Contaminated surface run-off can be transported laterally to areas with lower hydraulic heads or vertically to the water table.

The water quality of any wells down gradient of the site such as the Mango Walk wells would therefore be vulnerable, due to the direction of groundwater flow and the fact that these wells sit at a lower elevation than the site. The Mango Walk wells range in elevation from 27.19m to 28.30m amsl. This would have significant impacts on the supply of irrigation water for the sugar cane industries and horse farms within the agricultural plains to the south.

- c) Flooding: A depression lies at the centre of the proposed development. This coupled with the nature of the soil cover can lead to ponding of surface water run-off and flooding at the site, whereby the standing water has a greater chance to pick up pollutants before it is infiltrated. Also the Naseberry Grove #1 and #2 wells can be affected should the site become inundated by flood water.

Also in the Technical Note, the WRA provided a list of seven criteria for siting cemeteries. This proposed cemetery development fulfils five of the seven criteria, with the two outstanding criteria irrelevant as they deal with siting of cemeteries by Wetlands and Estuaries and Coastal/Marine Environment.

Therefore, the potential for groundwater or surface water contamination is minimal (see 6.2.1.3, 6.2.1.7 and 6.2.1.8).

#### **5.3.2.2 St. Catherine Parish Council (telephone - Mr Davio Robinson)**

Concerns were raised about the proposed location in proximity to residential areas and the possible visual impact. In addition, it was suggested that maybe the proposed development should be done on lands immediately north of the existing cemetery.

#### **5.3.2.3 National Works Agency (NWA) (email – Mr Ray Parchment)**

The main issues from a traffic standpoint were:

1. Size of access- min 9m with a minimum turning radii of 9m.
2. Pedestrian access or facilities.
3. Parking area(s).
4. The number of vehicles expected and time profile.

5. How are processions to be accommodated especially when two or three arrive simultaneously?
6. What is the proximity to existing intersections and or accesses?
7. What is the interconnectivity with existing cemetery?

#### 5.3.2.4 St. Catherine Health Department

Main issues raised were:

- The need for the proposed development to have a pest control plan
- The provision of a Columbarium (a room or simply a freestanding structure, wherein there are recessed compartments for placing urns containing cremation ashes)

#### 5.3.2.5 Jamaica National Heritage Trust (JNHT)

The Archaeology Division of Jamaica National Heritage Trust (JNHT) conducted an Archaeological Assessment on the proposed Dovecot Cemetery expansion at a part of Chisholm Called Bendon Pen, St Johns Road, St. Catherine. It has no objection to the proposed development but is recommending that the graveyard be preserved and that the JNHT be present at the initial removal of vegetation.

## 5.4 INDEX OF TECHNICAL RESPONSES TO STAKEHOLDER ISSUES IN THE EIA

Public input was incorporated into the proposed project design, the EIA; and environmental management systems. Responses to some of the issues are outlined in Table 5-1.

Table 5-1 Inventory of Responses to some Stakeholder Issues

Stakeholder Issues	Response
1) Road Repair	This is outside the scope of this EIA.
2) Improved Domestic Water Supply	This is outside the scope of this EIA.
3) Expectation of Job Creation	The estimated number of jobs and types are outlined in Section 3.4.8.
4) Impact of Cremation Emissions on Public Health	No cremation will be conducted on the proposed site.
5) Proximity of the Cemetery (discomfort)	The cemetery will not produce any undue nuisance noise or visual intrusion to nearby residences. The proposed site will be landscaped (Section 4.3.4).
6) Increased traffic congestion (especially on weekends) and increased difficulty to commute via public	It is anticipated that the impact will be minimal to no existent since the operation of the new cemetery is not expected to increase the level of vehicular traffic when compared to the

Stakeholder Issues	Response
transportation especially by taxis.	existing condition (see Section 4.3.1.9), as the existing Dovecot will not be accepting burials after the proposed project opens.
7) Impact on groundwater	It is anticipated that there will be minimal to no impact on groundwater (Section 6.2.1.8).
8) Risk of flash flooding	The proposed development of the site as a cemetery is not expected to contribute to flood risk in the area, and may even serve to reduce this risk (Sections 6.1.1.8, 6.1.1.11 and 6.2.1.7).
9) Locating the expansion of the cemetery north of the existing Dovecot property.	The developer does not own that property. In addition see Section 9.6.

## 5.5 COMMUNITY CONSULTATION AND PERCEPTION

### 5.5.1 Introduction

On May 31 and June 1, 2014 one hundred and fifty two (152) community questionnaires (Appendix 7), representing approximately two percent of the population within the two kilometre SIA for the expansion of the Dovecot Memorial Park were administered (Figure 4-38). 42.1% respondents were female and 57.9% were male. Of the one hundred and fifty two (152) respondents age cohort distribution was as follows; 5.9% were under 20 years of age , 21.7% were age 20-29 years, 14.5 % were age 30-39 years, 22.4% were age 40-49 years, 21.7% were age 50-59 years and 13.8 % were older than sixty-five years of age.

Eleven main communities were visited. These communities were Naseberry Grove, Dovecot, Mercury Gardens, Taylor Road, Bellevue Heights, Green Acres, Byles, Bendon, St Johns Heights, St Johns Meadows and Bellevue.

### 5.5.2 Results and Findings

Approximately five percent (5.3%) of all respondents had heard of Kumanda Park Limited while 94.7% of respondents indicated they had never heard of Kumanda Park Limited.

Seventy five percent (75 %) of respondents indicated that they heard of the company from other persons relaying information (“word of mouth”). As it related to respondents awareness of the proposal by Kumanda Park Limited to expand the Dovecot Memorial Park, 47.4% of respondents were aware of the proposal. While it could not be quantified, it was realised that most of the respondents who indicated an awareness of the proposal to expand Dovecot, further indicated that they were not aware that it was being undertaken by Kumanda Park Limited.



On the issue of concerns 45.4% of respondents indicated that they had concerns about the project. Approximately forty percent (40.1%) of interviewees indicated that they did not anticipate the project affecting their lives in any way; 24.3% of respondents were uncertain about whether or not the project would affect their lives. 9.2% of interviewees expected a positive effect on their lives as a result of the project while 26.3% of respondents indicated they expected their lives to be negatively affected. Concerns that were highlighted included the proximity of the cemetery to residences and the expected depreciation of property values.

Approximately thirty two percent (31.6%) of those interviewed stated that they were aware of existing cemetery capacity being reached. When asked about if deaths occurred in their family, 90.1% of respondents confirmed that they had lost loved ones. Of this 90.1% of respondents 99.3% of respondents indicated that loved ones were interred at either family plots (32.1%), private cemeteries (46.0%) or public cemeteries (11.7%), 8.8% at both private cemeteries and family plots and 0.7% interred at public and private cemeteries.

When asked about whether or not they used the lands of the proposed site for any type of business/farming/residence, 86.8% of those interviewed stated that they did not use the land for any type of activity.

When respondents were asked if they knew anyone who used the lands of the proposed site for any type of business/farming/residence, 78.9% of respondents indicated that they did not know anyone who used the land.

Percentages presented for community respondents are for the total number of respondents.

### 5.5.3 Naseberry Grove

Approximately six percent (5.9%) of respondents were interviewed in the Naseberry Grove area. Of this 55.6% of respondents were male and 44.4% were female. Age cohort distribution for those interviewed in Naseberry Grove was as follows; 11.1% were under 20 years of age, 0.0% were age 20-29 years, 33.3% were age 30-39 years, 33.3% were age 40-49 years, 22.2% were age 50-59 years and 0.0% were older than sixty-five years of age.

Approximately 88.9% of the respondents indicated that they have not heard of Kumanda Park Limited. Approximately forty four percent (44.4%) of respondents stated they were aware of the proposed cemetery expansion. While respondents indicated an awareness of the project, they were not aware that the project was being proposed by Kumanda Park Limited.

Regarding project concerns, 33.3% did not express any concern. Of the remaining 66.7% of respondents all were concerned about of another cemetery being proposed in an area that already has two cemeteries. Respondents were concerned that property values would decrease with the presence of cemetery (16.7%), they expressed concern about the proximity of the proposed cemetery to houses/people (33.3%), 16.7% expressed concern about the proximity of the burial spots to the church. Approximately thirty three percentage (33.3%) of respondents while indicating they had

concerns did not specifically state that their objection to the land being used for a cemetery, instead they indicated that the land could be used for alternate development such as a shopping centre, a gas station or for housing solutions, options which could generate employment opportunities. Approximately thirty three percentage (33.3%) of respondents were of the opinion that the project would not affect their lives in any way while 22.2% were not certain if the project would affect their lives. Approximately 44.4% anticipated a negative effect mainly due to an increase in traffic congestion, not wanting to reside beside a cemetery and not wanting to constantly see graves.

Approximately thirty three percentage (33.3%) indicated that they were aware that the existing cemetery capacity (public or private) would soon be exhausted while 66.7% of interviewees indicated they were not aware. 66.7% of Naseberry Grove interviewees indicated that they had deaths in their family. Of this 66.7%, all respondents indicated their loved ones were buried. 16.7% were buried at public cemeteries, 16.7% were buried at private cemeteries, 50% were buried at family plots and 16.7% indicated their loved ones were interred at both private cemeteries and family plots.

Respondents (11.1%) of Naseberry Grove indicated that they used the lands of the proposed site, specifically for business, however, their type of business was not specified. Approximately eighty nine percent (88.9%) of interviewees indicated that they did not use the land. Approximately eleven percent (11.1%) of respondents also indicated that they knew of someone who utilized the proposed lands and specifically for farming.

On the issue of water supply, flooding within the community and on the proposed site and the frequency of fire at the proposed site, respondents from Naseberry Grove indicated that there was a problem with water supply (66.7%), with the problem being attributed to no water (50%) and no pipes in the area (16.7%). All interviewees indicated that their community was not affected by flooding. Regarding flooding at the site, 88.9% of those interviewed indicated that the proposed site was not affected by flooding while others were uncertain (11.1%). All respondents indicate that the site was not affected by fire.

General comments received from interviewees of Naseberry Grove included that the area is in need of development, the cemetery is welcomed but it must be properly fenced, people will be surrounded by the cemetery, there is the need for water and road repairs, the area is nice, with a nice view and nice people who look for each other.

#### 5.5.4 Dovecot

Persons that were interviewed in the Dovecot area accounted for 7.9% of respondents. Most of the respondents were females (58.3%). Age cohort distribution for those interviewed in the Dovecot area was as follows; none under 20 years of age, 33.3% were age 20-29 years, 16.7% were age 30-39 years, 8.3% were age 40-49 years, 33.3% were age 50-59 years and 8.3% were older than sixty-five years of age.

Approximately eight percent (8.3%) of the respondents indicated that they had heard of Kumanda Park Limited, while 91.7% indicated they did not. A third (33.3%) of the respondents stated they were aware of the proposed cemetery expansion. While respondents indicated an awareness of the project, it was again realized that they were not aware that the project was being proposed by Kumanda Park Limited, as only a quarter (25%) of the respondents who indicated awareness of the project also indicated awareness of the company.

Regarding project concerns, 66.7% did not express any concern. Of the remaining 33.3% of respondents, three quarters (75%) expressed concern about the proximity of the proposed cemetery to houses/people, while a quarter (25%) were concerned about the what employment opportunities would be available.

Almost forty two percent (41.7%) of respondents were of the opinion that the project would affect their lives in any way while a quarter (25.0%) were uncertain if it would. Those persons that anticipated a positive impact attributable to an increase in job opportunities accounted for 16.7%, and an equal percentage (16.7%) anticipated a negative effect primarily due to the presence of additional cemetery and the loss of the area used as a football field.

The majority of the respondents were unaware that the existing cemeteries capacity (public or private) would soon be exhausted. Two thirds (66.7%) of interviewees indicated that they had deaths in their family and all respondents confirming deaths in the family, indicated that their loved ones were interred. A quarter (25%) indicated their loved ones were interred at a public cemetery, 37.5% were interred at private cemeteries, 25% indicated their loved ones were interred at family plots and 12.5% of respondents indicated their loved ones were interred at both public and private cemeteries.

Respondents (16.7%) from Dovecot indicated that they used the lands of the proposed site, of which half (50%) specifically for residence and the other half for harvesting of fruits for sale to generate income. The majority (83.3%) of interviewees indicated that they did not use the land. A quarter (25%) of respondents also indicated that they knew of someone who utilized the proposed lands and specifically for residence.

On the issue of water supply, flooding within the community or on the proposed site and the frequency of fire at the proposed site, respondents from Dovecot indicated that there was a problem with water supply (25%), with the problem being attributed to no water (66.7%) and low water pressure (33.3%). Approximately forty two percentage (41.7%) of interviewees indicated that their community was affected by flooding but only in times of very heavy rain. Regarding flooding at the proposed site, 41.7% of those interviewed indicated that the proposed site was affected by flooding and in times of very heavy rain. All respondents indicated that the site was not affected by fire.

General comments received from interviewees of Dovecot included that there are residential communities between the existing cemetery and the proposed location, which will mean that residents will be in the midst of the cemeteries; also it is hoped that with the proposed upgrade there will be the

fixing of Taylor Road. It is also hoped that there will be investments to help in providing financial opportunities.

### 5.5.5 Mercury Gardens

Approximately seven percent (7.2%) of the respondents were interviewed in the Mercury Gardens area. The majority (54.5%) of the respondents were female. Age cohort distribution for those interviewed in the Mercury Gardens area was as follows; 9.1% were under 20 years of age, 9.1% were age 20-29 years, 9.1% were age 30-39 years, 36.4% were age 40-49 years, 36.4% were age 50-59 years and no person older than sixty-five years of age.

All interviewees when asked if they have ever heard of a company called Kumanda Park Limited indicated that they did not know of the company. When respondents were asked about knowledge of Kumanda Park's proposal to expand cemetery, 45.5% of respondents indicated that they were aware of the proposed project but were unaware of Kumanda Park Limited's involvement.

Regarding project concerns, the majority (72.7%) of interviewees indicated that they had project concerns. Of this, 37.5% expressed concern about the proximity of the proposed cemetery to houses/people, 25% were concerned about the congestion on the main road and indicated that Kumanda Park Limited needed to make improvements to the existing roadway. It was further suggested that the developers may need to explore having traffic lights installed, to help control traffic flow to and from Dovecot, especially at the Job and Featherbed Lane intersection. The issues of pollution of groundwater were raised by 25% of respondents. These respondents were concerned about the effect that a large burial plot could have on the water supply and what associated health issues may arise. Approximately twelve percent (12.5%) of respondents from Mercury Gardens were concerned about the possible flooding of roads, blocked drains and the effect it would have on the community especially children attending basic schools.

The majority (54.5%) of the respondents were uncertain if the project would affect their lives whilst 36.4% were of the opinion that the project would not affect their lives in any way. No one anticipated a positive impact, whilst 9.1% anticipated a negative effect mainly due to the increase in vehicular traffic on the road.

Approximately forty six percent of the respondents (45.5%) indicated that they were aware that the existing cemetery capacity (public or private) would soon be exhausted. Almost ninety one percent (90.9%) of those interviewed indicated that they had deaths in their family. These respondents also indicated that their loved ones were buried (10% were interred at a public cemetery, 80% were interred at a private cemetery and 10% were interred at family plots).

All respondents from Mercury Gardens indicated that they did not use the lands of the proposed site, for any type of business, residence or farming. On the issue of being aware of anyone who used the proposed site for any type of business, residence or farming, 36.4% of respondents indicated they



were aware of such individuals. It was indicated that 50% used the land for residence, 25% used the land for business and farming and the remaining 25% did not state what the land was used for.

On the issue of water supply, flooding within the community or on the proposed site and the frequency of fire at the proposed site, respondents indicated that there was a problem with water supply (18.2%), with the problem being attributed irregular water supply (100%). Approximately nine percent (9.1%) of interviewees indicated that their community was affected by flooding but only in times of very heavy rain. Regarding flooding at the site, 18.2% of those interviewed indicated that the proposed site was affected by flooding in times of very heavy rain and further indicated that the water settles on the land where the Adventist Church is located and also the Taylor Road area. All respondents indicate that the site was not affected by fire.

General comments received from interviewees of Mercury Gardens included that the Taylor Road and Dovecot areas have a crime problem; however the actual Mercury Gardens community is quiet and peaceful and is a “nice” area to reside. It was also highlighted that the main road is in need of repair.

### 5.5.6 Taylor Road

Approximately fourteen percent (13.8%) of respondents were interviewed in the Taylor Road area of which the majority (57.1%) were female. Age cohort distribution for those interviewed in the Taylor Road area was as follows; no one under 20 years of age, 33.3% were age 20-29 years, 23.8% were age 30-39 years, 33.3% were age 40-49 years, 4.8% were age 50-59 years and 4.8% were older than sixty-five years of age.

When asked if they have ever heard of a company called Kumanda Park Limited 4.8% interviewees indicated that they knew of the company and were made aware of them by “word of mouth”. When respondents were asked about knowledge of Kumanda Park’s proposal to expand cemetery, 90.5% of respondents indicated that they were aware of the proposed project but were unaware of Kumanda Park Limited’s involvement.

Regarding project concerns, 61.9% of respondents indicated that they had project concerns. Of these, 23.1% expressed concerns about the proximity of the proposed cemetery to houses/people and its presence resulting in the depreciation of property and 7.7% while expressing they had concerns, did not specify the concern. The remaining 69.2% expressed multiple concerns, with the common concern being another cemetery being constructed in an area that already has others and its close proximity to residences and the general population especially children. Other concerns expressed related to the possible impact to the water supply, associated dust and noise impacts and the loss of privacy.

Approximately twenty four percent (23.8%) of respondents were of the opinion that the project would not affect their lives in any way while 19% were uncertain, 14.3% anticipated a positive impact and 42.9% anticipated a negative effect. Interviewees anticipating a positive effect expressed the expectation of more work opportunities and infrastructural improvements in the form of electricity and water and improved roads. Respondents indicating that the project would affect their lives negatively,

expected this impact due to the presence of more cemeteries in the area, increased dust from burning, depreciation of property, the cemetery activities affecting the public water quality and supply and the need to relocate from the current residence.

The majority (61.9%) of interviewees indicated they were unaware that the capacities of existing cemeteries (public or private) would soon be exhausted. Almost eighty six percent (85.7%) of respondents indicated that they had deaths in their family. These respondents also indicated that their loved ones were buried. Of these, 11.1% were interred at a public cemetery, 22.2% were interred at a private cemetery, 55.6% were interred at family plots and 11.1% indicated their loved ones were buried at both private cemeteries and family plots.

Approximately fifty two percent (52.4%) of respondents from Taylor Road indicated that they did not use the lands of the proposed site, for any type of business, residence or farming. On the issue of being aware of anyone who used the proposed site for any type of business, residence or farming, 23.8% of respondents indicated they were aware of such individuals. It was indicated that 60% used the land for business, 20% used the land for residence and farming and for the remaining 20% it was not stated what the specific land use was.

On the issue of water supply, flooding within the community and on the proposed site and the frequency of fire at the proposed site, respondents indicated that there was a problem with water supply (85.7%), with the main problem being attributed to no water (66.7%), no pipes in the area (22.2%), irregular water supply (5.6%) and irregular and low water pressure (95.6%). Approximately fifty two percent (52.4%) of interviewees indicated that their community was affected by flooding in times of very heavy rain. It was also highlighted that the lower section of Taylor Road floods, mainly from run off from the higher section of Taylor Road. Regarding flooding at the site, 23.8% of those interviewed indicated that the proposed site was affected by flooding and as a result of run off from higher areas as well as from digging activities on the site. All respondents indicate that the site was not affected by fire.

General comments received from interviewees of Taylor Road included the need for better roads, regular water supply and electricity supply. Respondents also communicated their preference for an alternate type of development such as housing. It was also highlighted that there is odour in the atmosphere; however no indication of the possible source was given. It was also expressed that residents residing closest to the site could be given financial assistance to relocate.

### 5.5.7 Bellevue Heights

Approximately nine percent (8.6 %) of respondents interviewed were from the Bellevue Heights area, of which 61.5% of the respondents were males. Age cohort distribution for those interviewed in the Bellevue Heights area was as follows; 15.4% were under 20 years of age, 23.1% were age 20-29 years, 15.4% were age 30-39 years, 15.4% were age 40-49 years, 30.8% were age 50-59 years and no persons older than sixty-five years of age.

All interviewees, when asked if they have ever heard of a company called Kumanda Park Limited indicated they had never heard of the company. When respondents were asked about knowledge of Kumanda Park's proposal to expand cemetery, 88.9% of respondents indicated that they were aware of the proposed project but were unaware of Kumanda Park Limited's involvement. The remaining 11.1% of respondents were not aware of the proposed project.

Regarding project concerns, 23.1% of those interviewed indicated that they did not have any concerns. Almost seventy seven percent (76.9%) of respondents indicated that they had project concerns. Of these, 30% expressed concern about the proximity of the proposed cemetery to houses/people, 30% were concerned about possible water contamination and 10% were concerned that their properties would be depreciate. The remaining 30% expressed multiple concerns, with the common concern being another cemetery being constructed. Issues of increased traffic congestion were raised by Bellevue Heights residents as the entrance to the community will be affected because it is immediately opposite the proposed site's St. Johns Road access.

Respondents (23.1%) were of the view that the project would not affect their lives in any way, 15.4% were not certain, 7.7% anticipated a positive impact and 53.8% anticipated a negative effect. Interviewees who anticipated a positive effect, indicated that the new cemetery will be available for use by the public. Respondents indicating that the project would affect their lives negatively indicated that the foul smell they currently experience when cremations are done at the existing Dovecot would worsen. They also indicated that the introduction of another cemetery will degrade their community and also result in increased difficulty to commute via public transportation, specifically taxis. It was also highlighted that the presence of another cemetery will affect the children and it is not considered appropriate for another cemetery to be within the community as it makes the area depressing.

Approximately thirty one percent (30.8%) of the respondents indicated that they were aware that the existing cemeteries capacities (public or private) would soon be exhausted while 69.2% were not aware. All of the respondents indicated that they had deaths in their family. These respondents also indicated that their loved ones were interred at a public cemetery (7.7%), interred at a private cemetery (46.2%), interred at family plots (38.5%) and 7.7% indicated their loved ones were buried at both private cemeteries and family plots.

The majority of respondents (84.6%) from Bellevue Heights indicated that they did not use the lands of the proposed site for any type of business, residence or farming. Approximately fifteen percent (15.4%) of the interviewees indicated that they used the land for business, residence or farming. Of this amount half (50%) indicated that the land was used for residence and the other half (50%) indicating that the land was used as a through road and for harvesting fruits. On the issue of being aware of anyone who used the proposed site for any type of business, residence or farming, 23.1% of respondents indicated they were aware of such individuals. It was indicated that a third (33.3%) used the land for business and the remaining two third (66.7%) did not state the specific use.

On the issue of water supply or flooding within the community and on the proposed site and the frequency of fire at the proposed site, respondents indicated that there was a problem with water supply (7.7%), with the problem being attributed to low water pressure (100%). Approximately fifteen percent (15.4%) of interviewees indicated that their community was affected by flooding in times of very heavy rain. Regarding flooding at the site, 38.5% of those interviewed indicated that the proposed site was affected by flooding. It was highlighted that the lower “sloped” end of Taylor Road floods, in heavy rains and may be associated with blocked drains. Over a third (38.5%) of respondents stated that there was no flooding at the proposed site, whereas 23.1% were not aware whether or not the site floods.

General comments received from interviewees of Bellevue Heights included the need for better roads and a community centre. Respondents also communicated their preference for an alternate type of development such as housing. It was also indicated that youth opportunities are needed. Interviewees also indicated that there may be improper garbage disposal activities taking place on the site, however this could not be verified as permission may have been obtained from Dovecot.

#### 5.5.8 Green Acres

Approximately fifteen percent (15.1%) of persons interviewed were from the Green Acres Community of which the majority (65.2%) were males. Age cohort distribution for those interviewed in the Green Acres area was as follows; no persons were under 20 years or aged 20-29 years, 17.4% were age 30-39 years, 8.7% were age 40-49 years, 34.8% were age 50-59 years and 39.1% were older than sixty-five years of age.

All respondents when asked if they have ever heard of a company called Kumanda Park Limited indicated that they were not aware of the company. When respondents were asked about knowledge of Kumanda Park’s proposal to expand cemetery, 21.7% of respondents indicated that they were aware of the proposed project but were unaware of Kumanda Park Limited’s involvement. Others were unaware of the proposed project.

Regarding project concerns, 69.6% of those interviewed indicated that they did not have any concerns, with 30.4% of respondents indicating that they had project concerns and in instances expressed multiple concerns. Approximately forty three percent (42.9%) expressed concern about the proximity of the proposed cemetery to residences/residential areas and 57.1% of respondents expressed multiple concerns which included possible water contamination and the risk of burying persons with contagious illnesses that could be transmitted post-mortem, depreciation of property value, increased traffic congestion especially on weekends, the introduction of undesirable people and lewd music in the community. There was concern about the loss of vegetation. Respondents were also concerned that the proposed land use to expand the cemetery was not appropriate and indicated that the proposed site could be better utilized for a housing development, school or church.

Approximately sixty five percent (65.2%) of Green Acres respondents were of the opinion that the project would not affect their lives in any way, 13% were not certain if it would affect their lives, 4.3%



anticipated a positive impact and 17.4% anticipated a negative effect. Interviewees anticipating a positive effect indicated a benefit as the Seventh Day Adventist Church would remain at its present location. Respondents that indicated that the project would affect their lives negatively stated that the proposed expansion of the cemetery will result in depreciation of their properties values.

A little over a third of the respondents (34.8%) indicated that they were aware that the existing cemetery capacity (public or private) would soon be exhausted while the other (65.2%) were not. The majority (95.7%) of respondents indicated that they had deaths in their family and also indicated that their loved ones were buried. Those were interred at a public cemetery (13.6%), 63.6% were interred at a private cemetery, 18.2% were interred at family plots and 4.5% indicated their loved ones were buried at both private cemeteries and family plots.

All of the respondents from Green Acres indicated that they did not use the lands of the proposed site, for any type of business, residence or farming. On the question of being aware of anyone who used the proposed site for any type of business, residence or farming, 13% of respondents indicated they were aware of such individuals. It was indicated that 33.3% used the land for business and the remaining 66.7% used the land for farming.

On the issue of water supply, flooding within the community or on the proposed site and the frequency of fire at the proposed site, respondents indicated that there was a problem with water supply (39.1%), with the problem being attributed to irregular water supply (55.6%), low water pressure (11.1%) and high turbidity (11.1%). Another 22.2% of respondents did not specify what problems they were having with the water supply. Thirteen percent (13%) of interviewees indicated that their community was affected by flooding, 33.3% indicated that flooding occurred in times of very heavy rain, and was also caused by run off from Meadow Rest which affects Green Acres in sections; 33.4% did not indicate an exact cause. Regarding flooding at the proposed site, 8.7% of those interviewed indicated that the proposed site was affected by flooding. It was highlighted that the site floods as a result of run off from Taylor Road. Approximately seventy percent (69.6%) of respondents stated that there was no flooding at the proposed site, 21.7% were not aware whether or not the site floods. Regarding fire at the proposed site, the majority (82.6%) indicated that there was not a problem with fire at the site while 17.4% were uncertain.

General comments received from interviewees of Green Acres included that there is the need for more jobs, the existing Dovecot Cemetery is sometimes visited for relaxation purposes; cemeteries are moving too close to homes, the community is “nice” and quiet and peaceful.

### 5.5.9 Byles

Approximately thirteen percent (13.2 %) of respondents interviewed were from the Byles Community of which 60.0% of respondents were males. Age cohort distribution for those interviewed in the Green Acres area were as follows; 15% were under 20 years of age, 35.0% were age 20-29 years, 0.0% were age 30-39 years, 30.0% were age 40-49 years, 15.0% were age 50-59 years and 5.0% were older than sixty-five years of age.

Ninety five percent (95%) of respondents when asked if they have ever heard of a company called Kumanda Park Limited indicated that they did not know of the company. When respondents were asked about knowledge of Kumanda Park's proposal to expand cemetery, 40% of respondents indicated that they were aware of the proposed project but were unaware of Kumanda Park Limited's involvement.

Regarding project concerns, 70% of those interviewed indicated that they did not have any concerns of which 30% indicated that they had project concerns and in instances expressed multiple concerns. Approximately seventeen percent (16.7%) of interviewees from Byles were concerned that there may be damage to the water supply. It was also highlighted that crime was intruding into the area. Almost a third (33.4%) of the respondents indicated their opposition to a cemetery being constructed on the site especially so close to the main. It was suggested that the proposed site could be used for alternate development such as housing, 16.7% highlighted the concern of property values being depreciated as well as the increased traffic and difficulty commuting during times of funeral processions. Approximately seventeen percent (16.7%) wondered if the developers would purchase other lands and 16.7% indicated that the Byles community was just recently developing, and the introduction of the cemetery will affect the children of the community and persons will not want to reside in the area

Forty five percent (45%) of the respondents in Byles were of the opinion that the project would not affect their lives in any way while 45% were not certain. No one anticipated a positive impact and 10.0% anticipated a negative effect. Respondents that indicated that the project would affect their lives negatively, stated that the proposed expansion of the cemetery would result in increased traffic (50%), while the other half (50%) did not specify what negative impacts they thought would arise from the proposed development.

Approximately thirty percent (30%) of the respondents indicated that they were aware that the existing cemetery capacity (public or private) would soon be exhausted. Ninety five (95.0%) of respondents indicated that they had deaths in their family and also indicated that their loved ones were buried with 10.5% interred at a public cemetery, 36.8% interred at a private cemetery and 31.6% were interred at family plots and 21.1% indicated their loved ones were buried at both private cemeteries and family plots.

All respondents from the Byles community indicated that they did not use the lands of the proposed site, for any type of business, residence or farming. On the subject of being aware of anyone who used the proposed site for any type of business, residence or farming, 20% of respondents indicated they were aware of such individuals. They said that 25% used the land for business, 25% for farming, 25% for residence and the use for the remaining 25% was not stated.

On the issue of water supply, flooding within the community or on the proposed site and the frequency of fire at the proposed site, respondents indicated that there was a problem with water supply (20%), with the problem being attributed to no water (50%) and irregular water supply (25%). 25% of respondents did not specify what the exact problem with water supply was related to. Forty five percent (45%) of interviewees indicated that their community was affected by flooding, with 77.8% of these

respondents indicating that flooding occurred in times of very heavy rain; 22.3% did not indicate an exact cause. Regarding flooding at the proposed site, 20% of those interviewed indicated that the proposed site was affected by flooding. It was highlighted that the site floods in times of very heavy rainfall. Twenty percent (20%) were not aware of whether or not the site floods. Regarding fire at the proposed site, 85% indicated that there was not a problem with fire at the site while 15% were uncertain.

General comments received from respondents in the Byles community included that there is the need for more jobs and overall development of the area, improvement in the road network and water supply. It was further indicated that Byles is a “good” quiet community with neighbourly people, even though there are instances of violence. Of specific note it was highlighted that the proposed site is not safe as there is an informal settlement in that area with questionable activities taking place.

### 5.5.10 Bendon

Approximately fifteen percent (15.1%) of respondents interviewed were from the Bendon Community of which 69.6% of respondents were males. The age cohort distribution for those interviewed in the were as follows; 8.7% were under 20 years of age, 21.7% were age 20-29 years, 13.0% were age 30-39 years, 21.7% were age 40-49 years, 17.4% were age 50-59 years and 17.4% were older than sixty-five years of age.

Slightly over ninety one percent (91.3%) of respondents when asked if they have ever heard of a company called Kumanda Park Limited indicated that they were not aware of the company. When respondents were asked about knowledge of Kumanda Park’s proposal to expand cemetery, 52.2% of respondents indicated that they were aware of the proposed project but were unaware of Kumanda Park Limited’s involvement.

Regarding project concerns, 69.6% of those interviewed indicated that they did not have any concern. Some persons (30.4%) indicated that they had project concerns and in instances expressed multiple concerns. The majority (57.1%) expressed concern about the proximity of the proposed cemetery to residences/residential areas and some of these respondents further expressed concern that due to the proximity of the cemetery to residences, there is the risk of disease outbreak, depreciation of property values and the location being too near to the main road. Within the 57.1% of individuals concerned about the proximity of the proposed site to residences, there was the concern regarding whether or not residents of Taylor Road would lose their homes, 14.3% of respondents expressed concern regarding the effect the cemetery could have on the underground water and 28.6% of interviewees while indicating that they had concerns about the project, expressed objection to the proposal to construct a cemetery on the lands and indicated that the land should be used for alternate development specifically housing.

Approximately thirty five percent (34.8%) of Bendon respondents were not of the opinion that the project would not affect their lives in any way whilst 21.7% were not certain if the project would affect their lives, 17.4% anticipated a positive impact and 26.1% anticipated a negative effect. Interviewees

anticipating a positive effect anticipated an increase in job opportunities (75%) and 25% anticipated a reduction in crime as well as an improvement in the water supply in Bendon. These respondents also indicated that the cemetery would be a nearby burial location that they could use and indicated too that the popularity of area would increase. Respondents indicating that the project would affect their lives negatively, stated that there would be too much noise from the bands during burials (16.7%), the risk/fear of disease outbreaks (16.7%), the proposed site being too close to their residences and will result in loss of property value (33.3%). The remaining third (33.3%), while indicating they expected a negative impact on their lives, did not state specifically the cause/nature of that effect.

The majority (65.2%) of interviewees indicated that they were not aware that the existing cemeteries capacities (public or private) would soon be. Over ninety five percent (95.7%) of respondents indicated that they had deaths in their family of which 95.5% indicated that their loved ones were buried and 4.5% indicated their loved ones were cremated (specially indicated that cremation was done overseas). For those persons buried, 9.1% were interred at a public cemetery, 40.9% were interred at a private cemetery, 40.9% were interred at family plots and 4.5% indicated their loved ones were buried at both private cemeteries and family plots.

The majority (82.6%) of respondents from Bendon indicated that they did not use the lands of the proposed site, for any type of business, residence or farming. Of the 17.4% who stated that they used the land, three quarters (75%) indicated that they used the land for farming and a quarter (25%) indicated that they used the land for both farming and residence. On the issue of being aware of anyone who used the proposed site for any type of business, residence or farming, 17.4% of respondents indicated they were aware of such individuals. It was indicated that 25% used the land for farming, 25% for residence, 25% for both residence and farming and 25% did not state the use.

On the issue of water supply, flooding within the community or on the proposed site and the frequency of fire at the proposed site, respondents indicated that there was a problem with water supply (39.1%), with the problem being attributed to no water (55.6%), no pipes in the area (22.2%) and low water pressure (11.1%). 11.1% of respondents did not specify what the exact problem with water supply was related to.

Over seventeen percent (17.4%) of interviewees indicated that their community was affected by flooding. All of interviewees indicated that flooding occurred in times of very heavy rain, with a quarter (25%) of this number specifying the stormy season. Regarding flooding at the proposed site, 30.4% of those interviewed indicated that the proposed site was affected by flooding. It was highlighted by the majority (71.4%) of respondents that the site floods as a result very heavy rains, 19.9% of respondents stated that there was no flooding at the proposed site, whilst 8.7% were not aware of whether or not the site floods. Regarding fire at the proposed site, 95.7% indicated that there was no problems with fire at the site whilst 4.3% were uncertain.

General comments received from interviewees of Bendon included that there was the need for more jobs, the need for a community centre, recreational facilities and sports. It was expressed also that



the community is a “nice” quiet community although criminality occurs. There is the need for better roads and drainage maintenance.

### 5.5.11 St Johns Heights

Approximately five percent (5.3 %) of respondents interviewed were from the St Johns Heights area of which the majority (87.5%) of were males. The age cohort distribution for those interviewed in the St Johns Heights area were as follows; no person under the age of 20 years, 50% were age 20-29 years, no person between the ages 30-39 years, 25% were age 40-49 years, 12.5% were age 50-59 years and 12.5% were older than sixty-five years of age.

Twelve and a half percent (12.5%) of interviewees when asked, indicated that they have heard of a company called Kumanda Park Limited. When respondents were asked about knowledge of Kumanda Park’s proposal to expand cemetery, 37.5% of respondents indicated that they were aware of the proposed project however awareness of Kumanda Park Limited’s involvement as uncertain.

Regarding project concerns, 62.5% of those interviewed indicated that they did not have any concerns. Thirty seven and a half percent (37.5%) of respondents indicated that they had project concerns. Of these, 33.3% expressed concern about the proximity of the proposed cemetery to houses and the associated depreciation of property close to the cemetery. A third (33.3%) of respondents indicated concerns relating to reckless driving from funeral processions and indicated that more policing was needed. A little over two thirds (66.7%) of respondents expressing concerns had multiple concerns. These were, related to the underground water supply and possible contamination as it related to pumping water to Green Acres, a nearby community. These respondents also highlighted that traffic due to road infrastructure and indiscipline associated with funeral goers was an issue as the individuals attending funerals were classified as unruly.

Three quarters (75%) of respondents were of the opinion that the project would not affect their lives in any way, whilst a quarter (25%) anticipated a negative effect. Respondents indicating that the project would affect their lives negatively, indicated that there will be an imposition on people’s environment, associated with pollution (50%). Concerns were specifically related to motor vehicle emissions. The increase in dust within the context of the area being a red dirt area was highlighted (50%).

The majority (62.5%) indicated that they were aware that the existing cemeteries capacities (public or private) would soon be exhausted. All of respondents indicated that they had deaths in their family. These respondents indicated that their loved ones were buried. Twelve and a half percent (12.5%) were interred at a public cemetery, 62.5% were interred at a private cemetery and 12.5% were interred at family plots and 12.5% indicated their loved ones were buried at both private cemeteries and family plots.

All of the respondents from St Johns Heights indicated that they did not use the lands of the proposed site, for any type of business, residence or farming. On the issue of being aware of anyone who used

the proposed site for any type of business, residence or farming, 12.5% of respondents indicated they were aware of such individuals, all of whom used the land for residence.

On the issue of water supply, flooding within the community or the proposed site and the frequency of fire at the proposed site, respondents indicated that there was a problem with water supply (12.5%), with the problem being attributed to few persons having connections to the National Water Commission (100%). It was not determined if the lack of connections to NWC was as a result of opting not to connect to the NWC's supply.

A quarter (25%) of interviewees indicated that their community was affected by flooding, and specified that flooding was caused by the overflowing of blocked drains. Regarding flooding at the site, 37.5% of those interviewed indicated that the proposed site was affected by flooding, with 33.3% of these specifying that flooding at the proposed site occurs in times of very heavy rains. The remaining 66.7% did not specify a possible cause for the proposed site's flooding. All respondents indicated that there was not a problem with frequent fires at the site.

General comments received from interviewees of St Johns Heights included the need for better roads and lighting. It was also highlighted that the community has a Citizens' Association that meets on the last Sunday of each month. Respondents also communicated that their community was quiet and peaceful; however this may be compromised due to the migration of persons into the community. Additional comments included the need for persons to be connected to the water supply.

### 5.5.12 St Johns Meadows

Approximately four percent (3.9%) of respondents interviewed were from the St Johns Meadows area. 33.3% of respondents were male and 66.7% were female. Age cohort distribution for those interviewed in the St Johns Meadows area was as follows; no persons under the age of 20 years or aged 20-29 years or aged 40-49 years, 33.3% were age 30-39 years, 16.7% were age 50-59 years and 50% were older than sixty-five years of age.

All of the interviewees when asked, indicated that they had never heard of a company called Kumanda Park Limited. When respondents were asked about the proposal to expand the cemetery, 66.7% of respondents indicated that they were not aware of the proposed project.

Regarding project concerns, 33.3% of those interviewed indicated that they did not have any concerns. Of the 66.7% respondents indicating that they had project concerns, a quarter (25%) of those expressing concerns indicated their objection to having the cemetery at the proposed site as it would result in too much congestion on the main road, 25% indicated their displeasure in having to constantly see graves once the proposed site is operational and 25% were concerned about the effect of the fugitive dust, the increased noise in the area and the potential hazards due to the absence of an adequate sidewalk. The need for wider roads was also highlighted as a concern related to the project. Respondents (25%) expressing concern indicated their opposition to living in an area with a cemetery and were concerned that the activities from the burial site might disturb the residents.

Approximately seventeen percent (16.7%) of respondents were of the opinion that the project would not affect their lives in any way, whilst 33.3% anticipated a negative effect. Respondents indicating that the project would affect their lives negatively stated that the presence of a cemetery so close to residence will affect individuals' "peace of mind" (50%). It was also opined that the proposed location was too close to the main road and thus would negatively affect individuals' lives. Approximately seventeen percent (16.7%) of those interviewed anticipated that the project would have a positive effect on their lives but did not indicate any specific expectation and 33.3% were not certain.

Approximately eighty three percent (83.3%) of interviewees indicated that they were unaware that the existing cemeteries capacities (public or private) would soon be exhausted. All of the respondents indicated that they had deaths in their family and also indicated that their loved ones were buried. Approximately seventeen percent (16.7%) were interred at a public cemetery, 50% were interred at a private cemetery and 33.3% were interred at family plots.

All of the respondents from St Johns Meadows indicated that they did not use the lands of the proposed site, for any type of business, residence or farming nor did they know of anyone who used the proposed site for any type of business, residence or farming.

On the issue of water supply, flooding within the community or on the proposed site, and the frequency of fire at the proposed site, those interviewed, a third (33.3%) indicated that there was a problem with water supply, half (50%) of which were problems being attributed to irregular water supply and the other 50% not indicating the potential cause.

Regarding flooding within the community, at the proposed site and frequent fires at the proposed site, all respondents in all cases indicated that there was not a problem within the community or at the proposed site.

General comments received from interviewees of St Johns Meadows indicated that the community was quiet and peaceful. Other comments indicated that the gun salutes affected the community. It was also expressed that the St Johns Meadows community is far removed from the police, schools and businesses and more street lights are needed and the road infrastructure needs improving.

### **5.5.13 Bellevue**

Approximately four percent (3.9 %) of respondents interviewed were from the Bellevue area of which 66.7% of respondents were males. Age cohort distribution for those interviewed in the Bellevue Heights area were as follows; no persons under the age of 20 or 30-39 years, 33.3% were age 20-29 years, 33.3% were age 40-49 years, 16.7% were age 50-59 years and 16.7% were older than sixty-five years of age.

Approximately seventeen percent (16.7%) of the interviewees when asked if they have ever heard of a company called Kumanda Park Limited, indicated that they knew of the company. When respondents were asked about knowledge of Kumanda Park's proposal to expand cemetery, 16.7% of respondents indicated that they were aware of the proposed project.

Regarding project concerns, 83.3% of those interviewed indicated that they did not have any concerns. The 16.7% of respondents who indicated that they had project concerns, the concern was that there were too many cemeteries already present in the area. Of the 83.3% who expressed that they did not have any concerns over the proposed project, 33.3% were of the opinion that the project would not affect their lives in any way, 16.7% were not certain if it would and 33.3% anticipated a positive impact.

Half (50%) of the interviewees anticipating a positive effect indicated that they anticipate positive activities however, they did not specify the activity, whilst the other half (50%) did not indicate how the project would result in a positive effect.

All respondents that indicated that the project would affect their lives negatively, indicated that the area would depreciated. Half of whom (50%) indicated that they were aware that the existing cemeteries capacities (public or private) would soon be exhausted. Approximately eighty three percent (83.3%) of respondents indicated that they had deaths in their family. Eighty percent (80%) of these respondents also indicated that their loved ones were buried and 20% indicated that their loved ones were buried and cremated, none were interred at a public cemetery, 60% were interred at a private cemetery, 20% were interred at family plots and 20% indicated their loved ones were buried at both private cemeteries and family plots.

Approximately eighty three percent (83.3%) of respondents from Bellevue indicated that they did not use the lands of the proposed site, for any type of business, residence or farming. The 16.7% of the interviewees indicated that they used the land for business, residence and farming. On the issue of being aware of anyone who used the proposed site for any type of business, residence or farming, 66.7% of respondents indicated they were aware of such individuals. It was indicated that a quarter (25%) used the land for both residence and business and the remaining 75% did not state what specifically the land was used for.

On the issue of water supply, flooding within the community or on the proposed site and the frequency of fire at the proposed site, 16.7% of respondents indicated that there was a problem with water supply, with the problem being attributed to no pipes being run in the area.

Approximately seventeen percent (16.7%) of interviewees indicated that their community was affected by flooding but did not provide any details on the problem. Regarding flooding at the site, a third (33.3%) of those interviewed, indicated that the proposed site was affected by flooding, but no details were supplied. Approximately eighty three percent 83.3% of interviewees indicated the site was not affected by fire whilst 16.7% indicated that they did not know.



## 6.0 IDENTIFICATION AND ASSESSMENT OF POTENTIAL DIRECT AND INDIRECT IMPACTS AND RECOMMENDED MITIGATION

Impact matrices for the site preparation/construction and operational phases were created utilising the following criteria<sup>11</sup>:

- **Direction of Impact-** This describes the nature of the potential impact; positive, negative or no impact of a particular activity on a receptor.
- **Magnitude of Impact:** This is defined by the severity of each potential impact and indicates whether the impact is irreversible or, reversible and estimated potential rate of recovery. The magnitude of an impact cannot be considered high if a major adverse impact can be mitigated.
- **Extent of Impact:** The spatial extent or the zone of influence of the impact should always be determined. An impact can be site-specific or limited to the project area; a locally occurring impact within the locality of the proposed project; a regional impact that may extend beyond the local area and a national impact affecting resources on a national scale and sometimes trans-boundary impacts, which might be international.
- **Duration of Impact:** Environmental impacts have a temporal dimension and needs to be considered in an EIA. Impacts arising at different phases of the project cycle may need to be considered.
- **Significance of the Impact:** This refers to the value or amount of the impact. Once an impact has been predicted, its significance must be evaluated using an appropriate choice of criteria. The most important forms of criterion are:
  - Specific legal requirements e.g. national laws, standards, international agreements and conventions, relevant policies etc.
  - Public views and complaints
  - Threat to sensitive ecosystems and resources e.g. can lead to extinction of species and depletion of resources, which can result, into conflicts.
  - Geographical extent of the impact e.g. has trans- boundary implications.
  - Cost of mitigation
  - Duration (time period over which they will occur)
  - Likelihood or probability of occurrence (very likely, unlikely, etc.)
  - Reversibility of impact (natural recovery or aided by human intervention)
  - Number (and characteristics) of people likely to be affected and their locations
  - Cumulative impacts e.g. adding more impacts to existing ones.
  - Uncertainty in prediction due to lack of accurate data or complex systems. Precautionary principle is advocated in this scenario.

<sup>11</sup> Taken from - Ogola, P. F. A. 2007. Environmental Impact Assessment General Procedures, presented at Short Course II on Surface Exploration for Geothermal Resources, organized by UNU-GTP and KenGen, at Lake Naivasha, Kenya, 2-17 November, 2007

In addition to the criteria listed previously for identifying potential impacts, those were supplemented by:

- The Consultants' experience,
- Documented impacts from similar projects,
- The data collected,
- Analysis of the processes in the proposed project,
- Information generated from models,
- Concerns raised from stakeholders in the social surveys; and
- Discussions held among the EIA Study team.

Table 6-1 shows the impact assessment criteria for the various potential impacts.

Table 6-1 Impact assessment criteria for potential environmental impacts

SCORE	0	1	2	3
CRITERIA	Negligible	Minor	Moderate	Significant
<b>DURATION</b>	None	Physical impacts lasting less than a few months before recovery occurs. Impact does not persist after the activity ends.	Physical impacts lasting from a few months to two years before signs of recovery. It is not inter-generational.	Physical impact is persistent after 2 years. Impacts on a biological population over a number of recruitment cycles or generations of the population.
<b>MAGNITUDE</b>	No measurable change in availability of resources or function of systems. No measurable effect on people.	Changes in form and/or ecosystem function and/or a resource. The system maintains the ability to support ecosystem/resource functions with only minor changes in community value and no overall loss/gain. Only a small fraction of the local community is affected.	Changes in form and/or ecosystem function and/or a resource. The system's ability to support ecosystem/resource functions and economic benefit is affected but not lost. Only a moderate fraction of the local community is affected.	Changes in form and/or ecosystem function and/or a resource. The system's ability to support ecosystem/resource functions and economic benefit is highly affected. A large fraction of the local community is affected.
<b>EXTENT</b>	None	Isolated effects within activity site.	Localized area close to borders or offsite dispersion pathways.	Widespread: offsite regional effects

Table 6-2 Impact matrix for site preparation and construction phases of cemetery

	RECEPTOR	IMPACT	DIRECT/INDIRECT		DIRECTION			DURATION	MAGNITUDE	EXTENT	SIGNIFICANCE SCORE	
			Direct	Indirect	Pos	None	Neg					
Site Preparation and Construction Phases												
Biological Impacts	Invertebrates	Species loss , displacement and loss of habitat	X				X	1	1	1	-1	
	Avifauna	Species loss , displacement and loss of habitat	X				X	1	1	1	-1	
	Herpetofauna	Species loss , displacement and loss of habitat	X				X	1	1	1	-1	
	Flora/Vegetation	Species loss , displacement and loss of habitat	X				X	1	1	1	-1	
	Air Shed	Increased noise pollution		X				X	1	1	1	-1
		Increased dust/particulates		X				X	1	1	2	-1.33
Physical Impacts	Groundwater Quality/Sinkholes	Sinkhole and soak wells pollution – oils and grease, TSS, turbidity.	X				X	1	1	1	-1	
		Sinkhole blockage from debris	X				X	1	1	1	-1	
	Drainage and Waterways	Increased runoff rate		X				X	1	1	1	-1
		Increased localized flooding		X				X	1	2	2	-1.67

	RECEPTOR	IMPACT	DIRECT/INDIRECT		DIRECTION			DURATION	MAGNITUDE	EXTENT	SIGNIFICANCE SCORE
			Direct	Indirect	Pos	None	Neg				
		Flooding of adjacent communities		X			X	1	2	2	-1.67
Construction Crew	Existing natural and social environment	Increased solid waste generation	X				X	1	1	1	-1
		Increased wastewater generation	X				X	1	1	1	-1
		Increased accidental potential	X				X	1	1	2	-1.33
Social Impacts	Local Community	Increased employment	X		X			1	1	2	1.33
	Commuters and Pedestrians	Increased Accident Potential	X				X	1	1	1	-1
		Increased Traffic	X				X	1	1	2	-1.33
	Heritage/Cultural	Destruction of historical artefacts	X				X	1	1	1	-1
	Viewshed (Aesthetics)	Improperly stored construction debris and solid waste	X				X	1	1	1	-1
											-1.4



Table 6-3 Impact matrix for operation phase of cemetery

	RECEPTOR	IMPACT	DIRECT/INDIRECT		DIRECTION			DURATION	MAGNITUDE	EXTENT	SIGNIFICANCE SCORE
			Direct	Indirect	Pos	None	Neg				
Operational Phase											
Biological Impacts	Invertebrates	Habitat Fragmentation		X			X	1	1	1	-1
		Species Loss		X			X	1	1	1	-1
		Habitat Fragmentation		X			X	1	1	1	-1
		Increased Competition		X			X	1	1	2	-1.33
	Avifauna	Habitat Fragmentation		X			X	1	1	1	-1
		Species Loss		X			X	1	1	1	-1
		Habitat Fragmentation		X			X	1	1	1	-1
		Increased Competition		X			X	1	1	2	-1.33
	Herpetofauna	Habitat Fragmentation		X			X	1	1	1	-1
		Species Loss		X			X	1	1	1	-1
		Habitat Fragmentation		X			X	1	1	1	-1
		Increased Competition		X			X	1	1	2	-1.33
	Flora/Vegetation	Habitat Fragmentation		X			X	1	1	1	-1
		Species Loss		X			X	1	1	1	-1
		Habitat Fragmentation		X			X	1	1	1	-1
		Increased Competition		X			X	1	1	1	-1
Physical Impacts	Air Shed	Increased noise nuisance during funerals	X				X	1	1	1	-1
		Increased noise nuisance from lawnmowers during maintenance of grounds	X				X	1	1	1	-1

	RECEPTOR	IMPACT	DIRECT/INDIRECT		DIRECTION			DURATION	MAGNITUDE	EXTENT	SIGNIFICANCE SCORE	
			Direct	Indirect	Pos	None	Neg					
		Increased noise nuisance from excavators during vault construction	X				X	1	1	1	-1	
		Air emissions from lawnmowers and excavators	X				X	1	1	1	-1	
	Drainage and Waterways	Improved channeling of stormwater into sinkholes.		X	X			3	2	2	2.33	
		Less localized flooding		X	X			3	2	2	2.33	
	Groundwater Quality (aquifer)/Sinkholes	Sinkhole and soak wells pollution – oils and grease, TSS, turbidity, embalming chemicals, ammoniacal compounds from decomposition.	X				X	3	2	2	-2.33	
	Buildings and Structures	Damage and/or destruction from hurricane/earth quake		X			X	1	2	1	-1.33	
	Existing natural and social environment	Increased wastewater generation	X				X	3	1	1	-1.67	
		Increased water usage	X				X	3	1	1	-1.67	
	Social Impacts	Local Community	Increased employment	X		X			3	1	2	2
		Urban dwellers	Increased burial capacity	X		X			3	3	3	3
Viewshed (Aesthetics)		Visible headstones					X	3	1	1	-1.67	
										-0.8		

## 6.1 SITE PREPARATION AND CONSTRUCTION

### 6.1.1 Physical

#### 6.1.1.1 Noise Pollution

Site clearance for the proposed cemetery necessitates the use of heavy equipment to carry out the job. These equipment include bulldozers, backhoes, excavators etc. These possess the potential to have a direct negative impact on the noise climate. Noise directly attributable to site clearance activity should not result in noise levels in the residential areas to exceed 55dBA during day time (7am – 10 pm) and 50dBA during night time (10 pm – 7 am). Where the baseline levels are above the stated levels then it should not result in an increase of the baseline levels by more than 3dBA.

Construction noise can result in short-term impacts of varying duration and magnitude. The construction noise levels are a function of the scale of the project, the phase of the construction, the condition of the equipment and its operating cycles, the number of pieces of construction equipment operating concurrently. To gain a general insight into potential construction noise impacts that may result from the project, the typical noise levels associated with various types of construction equipment are identified in Table 6-4.

Table 6-4 – Typical construction equipment noise levels

Type of Equipment	Typical Sound Level at 50 ft. (dBA Leq.)
Dump Truck	88
Portable Air Compressor	81
Concrete Mixer (Truck)	85
Jackhammer	88
Scraper	88
Bulldozer	87
Paver	89
Generator	76
Piledriver	101
Rock Drill	98
Pump	76
Pneumatic Tools	85
Backhoe	85

*Adapted from - Route 101A Widening and Improvements, City of Nashua Hillsborough County, New Hampshire; McFarland-Johnson, Inc. May 30, 2007*

#### Recommended Mitigation:

- i. Use equipment that has low noise emissions as stated by the manufacturers.
- ii. Use equipment that is properly fitted with noise reduction devices such as mufflers.

- iii. Operate noise-generating equipment during regular working hours (e.g. 7 am – 7 pm) to reduce the potential of creating a noise nuisance during the night.
- iv. Construction workers operating equipment that generates noise should be equipped with noise protection. A guide is workers operating equipment generating noise of  $\geq 80$  dBA (decibels) continuously for 8 hours or more should use ear muffs. Workers experiencing prolonged noise levels 70 - 80 dBA should wear earplugs.

#### **6.1.1.2 Air Quality**

Site preparation has the potential to have a two-folded direct negative impact on air quality of the surrounding residential area. The first impact is air pollution generated from the construction equipment and transportation. The second is from fugitive dust from the proposed construction areas and raw materials stored on site. Fugitive dust has the potential to affect the health of construction workers, the resident population and the surrounding vegetation.

#### **Recommended Mitigation:**

- i. Areas should be dampened every 4-6 hours or within reason to prevent a dust nuisance and on hotter days, this frequency should be increased.
- ii. Minimize cleared areas to those that are needed to be used.
- iii. Cover or wet construction materials such as marl to prevent a dust nuisance.
- iv. Where unavoidable, construction workers working in dusty areas should be provided and fitted with N95 respirators.

#### **6.1.1.3 Solid Waste Generation**

During this construction phase of the proposed project, solid waste generation may occur mainly from:

- i. From the construction campsite.
- ii. From construction activities such as site clearance and excavation (vegetative debris).
- iii. Construction materials packaging (cardboard, plastics, fencing material, wooden pallets, containers etc.)
- iv. Earth materials from grading, roadway construction etc.

#### **Recommended Mitigation:**

- i. Skips and bins should be strategically placed within the campsite and construction site.
- ii. The skips and bins at the construction campsite should be adequately designed and covered to prevent access by vermin and minimise odour.
- iii. The skips and bins at both the construction campsite should be emptied regularly to prevent overfilling.
- iv. Disposal of the contents of the skips and bins should be done at an approved disposal site.



#### **6.1.1.4 Wastewater Generation and Disposal**

With every construction campsite comes the need to provide construction workers with showers and sanitary conveniences. The disposal of the wastewater generated at the construction campsite has the potential to have a minor negative impact on groundwater.

##### **Recommended Mitigation:**

- i. Provide portable sanitary conveniences for the construction workers for control of sewage waste. A ratio of approximately 25 workers per chemical toilet should be used.
- ii. Showers should be provided for the workers.

#### **6.1.1.5 Storage of Raw Material and Equipment**

Any raw materials used in construction will be stored onsite. There will be a potential for them to become air or waterborne. Stored fuels and the repair of construction equipment has the potential to leak hydraulic fuels, oils etc.

##### **Recommended Mitigation:**

- i. A central area should be designated for the storage of raw materials. This area should be lined in order to prevent the leakage of chemicals into the sediment.
- ii. Raw materials that generate dust should be covered or wetted frequently to prevent them from becoming air or waterborne.
- iii. Fine grained materials (sand, marl, etc.) will be stockpiled away from drainage channels and low berms will be placed around the piles which themselves will be covered with tarpaulin to prevent them from being eroded and washed away.
- iv. Raw material should be placed on hardstands surrounded by berms.
- v. Equipment should be stored on impermeable hard stands surrounded by berms to contain any accidental surface runoff.
- vi. Bulk storage of fuels and oils should be in clearly marked containers (tanks/drums etc.) indicating the type and quantity being stored. In addition, these containers should be surrounded by bunds to contain the volume being stored in case of accidental spillage.

#### **6.1.1.6 Transportation of Raw Material and Equipment**

The transportation and use of heavy equipment and trucks is required during construction. Trucks will transport raw materials and heavy equipment. This has the potential to directly impact traffic flow along local roads (Kitson Town Main Road and St. Johns Road).

##### **Recommended Mitigation:**

- i. Paths of the planned roadways should be used, rather than creating temporary pathways just for equipment access.

- ii. Adequate and appropriate road signs should be erected to warn road users of the construction activities. For example reduced speed near the construction site.
- iii. Raw materials such as marl and sand should be adequately covered within the trucks to prevent any escaping into the air and along the roadway.
- iv. The trucks should be parked on the proposed site until they are off loaded.
- v. Heavy equipment should be transported early morning (12 am – 5 am) with proper pilotage.
- vi. The use of flagmen should be employed to regulate traffic flow.

#### **6.1.1.7 Geology and Soils**

There are no apparent geotechnical issues that are significant enough to prevent the use of this property as a cemetery. On the contrary, considering the thickness of the red soils, most of the property to northwest of the limestone ridge, appears to be ideally suitable for the construction of multi-level vaults. Sinkholes are not a prevalent feature of the chalky Walderston Formation but like everywhere in the limestone, one needs to consider the possibility of the presence and development of sinkhole. If significant construction is contemplated in the area immediate around the sinkhole, it should be carefully inspected to determine the extent of the sinkhole. Guided by the findings of the hydrogeological assessment an appropriate setback from the sinkhole should also be maintained for the construction of the vaults. Although the limestone ridge can be used for the construction of vaults, the recommended use from a geotechnical point of view would be for the construction of supporting facilities.

#### **Recommended Mitigation:**

If significant construction is contemplated in the area immediate around the sinkhole, it should be carefully inspected to determine the extent of the sinkhole. Guided by the findings of the hydrogeological assessment, an appropriate setback from the sinkhole should also be maintained for the construction of the vaults. Although the limestone ridge can be used for the construction of vaults, the recommended use from a geotechnical point of view would be for the construction of supporting facilities.

#### **6.1.1.8 Runoff**

Both the peak runoff and total runoff from the site will increase after the site is developed. The estimated peak runoff from the existing site is estimated to be in the order of 2.25m<sup>3</sup>/s from the 2 yr event to 6.24m<sup>3</sup>/s for the 100 year event; these will be increased by a total of 29 down to 13 percent respectively for the post-development scenario. Similarly, the overall runoff for a 24hr storm will vary from 14,568 cubic metres to 40,350 cubic metres per day for the 2 to 100 year return storm. The increases will move from 28% to 15% in moving from the 2 to 100 year storm event. The increases will be due to increased impervious surfaces onsite as well as the anticipated increases in rainfall intensity in thirty years.

Table 6-5 Comparison of the peak runoff from the site for the existing and post development condition

Return Period (yr)	2	5	10	25	50	100
<b>Peak runoff (m3/s)</b>						
Existing	2.25	3.31	4.04	4.95	5.61	6.24
Post-development	2.90	4.04	4.80	5.74	6.41	7.05
Increase	29%	22%	19%	16%	14%	13%

Table 6-6 Comparison of the total 24hr rainfall runoff from the site for the existing and post development condition

Return Period (yr)	2	5	10	25	50	100
<b>Total Runoff (m3)</b>						
Existing	14568	21280	25969	31869	36166	40350
Post-development	18609	26042	31133	37458	42022	46437
Increase	28%	22%	20%	18%	16%	15%

**Recommended Mitigation:**

The proposed project will maintain the existing natural drainage conditions. Hardscape areas such as roads and parking lot will capture surface water via curbs and channels and deposit in soak wells or sinkholes.

**6.1.1.9 Soil Erosion**

Similarly, the clearing of the site will reduce the natural infiltration in the soil and promote erosion especially in the upper layers of the soil during extreme rainfall events. The soil (St. Ann Clay loam) found on the site has moderate to high susceptibility to erosion according to (Vernon & Jones, 1958).

One of the most widely used and accepted equations for estimating soil erosion is the Universal Soil Loss Equation (USLE), an empirical equation developed by the U.S. Department of Agriculture. The USLE estimates the annual tonnage of soil eroded from the site attributed only to a sheet and rill erosion. However, not all eroded soil qualifies as soil loss due to the fact that eroded soil may be re-deposited before it leaves a slope and therefore does not factor into soil loss quantity. The formula for USLE is:

$$A = R \times K \times LS \times C \times P$$

Where A is the average annual soil loss measured in tons/acre, R is the rainfall erosion index, K is the soil erodibility factor, LS is the length-slope factor, C is the cover factor and P is the erosion control practice factor.

The rainfall erosion index (R) is the product of the total raindrop energy (E) and the maximum 30-minute intensity ( $I_{30}$ ). The  $I_{30}$  values for a specific location were obtained by summing the  $I_{30}$  values for significant storms from a maximum 22-year record to obtain an average annual index value. The values of  $EI_{30}$  were obtained using:

$$EI_{30\text{-annual}} = 12.142(abc)^{0.6446}$$

where a is the annual precipitation, b is the annual maximum daily precipitation and c is the annual maximum hourly precipitation, all derived from rainfall datasets, so that average annual total of the storm EI values (R-factor) may be computed as:

$$R = \frac{1}{N} \sum_1^N EI_{30\text{-annual}}$$

Where N is the year period.

The K factor is an empirical value representing the erodibility per rainfall erosion unit. Generally, soils with  $K < 0.23$  are low-erodibility soils and soils with  $K > 0.41$  are considered highly erodible.

The combined topographic effects of length and steepness of a slope are accounted for in the LS factor. LS values range from less than 1 for short, flat slopes to nearly 50 for long, steep slopes, as demonstrated by the equation:

$$LS = \left(\frac{L}{72.6}\right)^m \left(\frac{430x^2 + 30x + 0.43}{6.574}\right)$$

Where L is the slope length in feet from the point of origin of overland flow to either the point where slope decreases to the extent that deposition occurs or the point where runoff enters well-defined channels,  $m = 0.5$  for slopes  $\geq 5\%$ ,  $m = 0.4$  for slopes 3.5% and 4.5%,  $m = 0.3$  for slopes  $\leq 3\%$ ,  $x = \sin \theta$  where  $\theta$  is slope angle in degrees.

The C factor is essentially a ratio of the soil loss from a specific cover condition to the soil loss from a clean, tilled, fallow condition for the same soil, slope and rainfall conditions. It is an index of the type of ground cover and the condition of the soil over the area.

The P factor is defined as the ratio of soil loss with a given surface condition (contouring, control structures, roughening the soil) to soil loss with up-and-down hill ploughing. This factor accounts for ground surface conditions that affect the runoff velocity.

Debris flow in the drainage channels typically includes soils and other loose materials. Analysis of the predicted soil loss map (Figure 6-1) concluded that the site and its environs are located in zones of moderate to low soil loss. The increased removal of vegetation however will increase the sediment



loading to the streams and ultimately the sinkholes. The present estimated soil loss for the site is 104 tons per acre per year which is estimate to increase by at least 20 percent if the site is cleared.

The designers should therefore take the necessary precautions to prevent the sinkholes being silted up during and after construction.

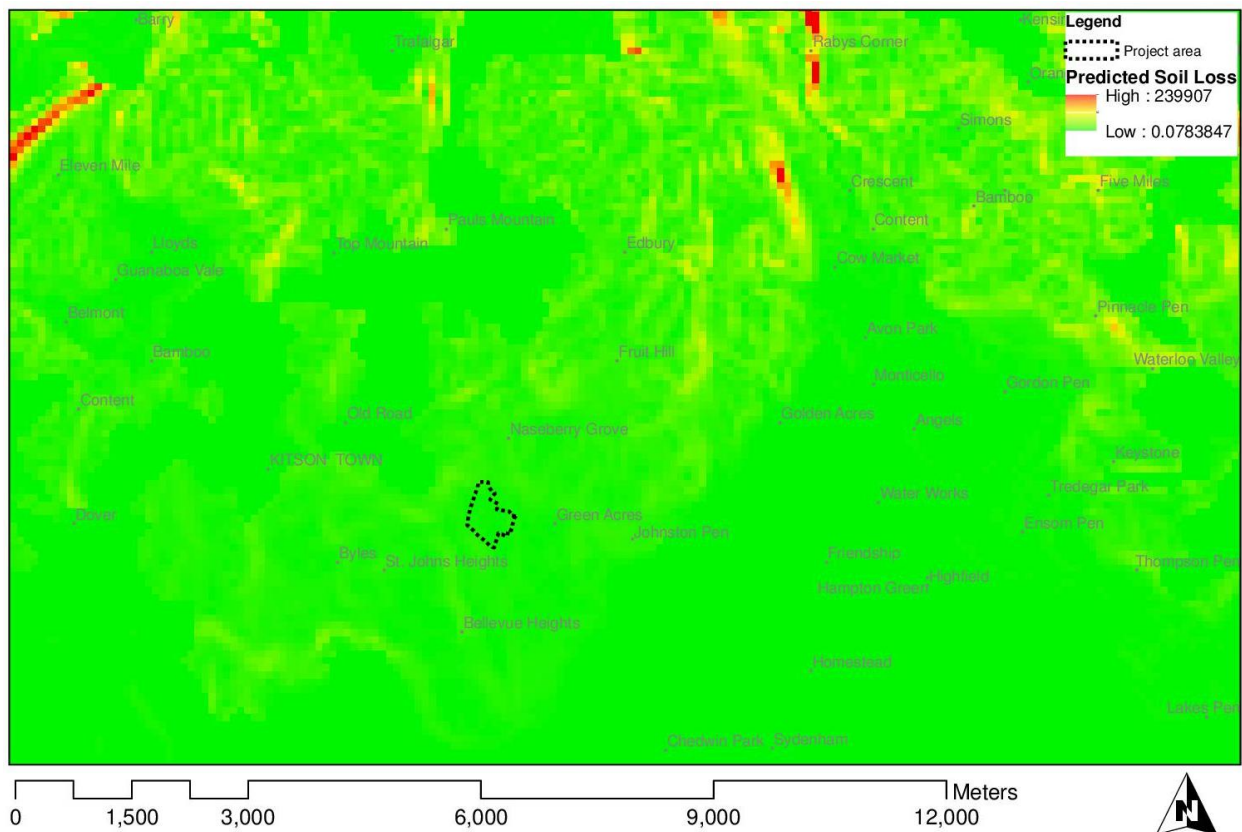

Figure 6-1 Soils Map of the wider Kitson town and Paul Mountain area surrounding the site

### 6.1.1.10 Stormwater and Flooding

The stormwater channels will be modified during the clearing of the site and this could cause localized flooding on the site and possibly to the communities adjacent to the site.

#### Recommended Mitigation:

- i. Care should be taken not to dispose of debris in the existing drains.
- ii. Temporary drains inclusive of adequate silt basins must be installed to prevent flooding.

#### 6.1.1.11 Blockage of sinkholes

The debris produced on the site during the clearance exercises could block the sinkholes and lead to localized flooding on the site and possibly to the communities adjacent to the site.

#### Recommended Mitigation:

- i. Care should be taken not to dispose of debris in the sinkholes during site clearance.
- ii. Temporary sediment traps should be installed to prevent silt from the cleared areas getting into the sinkholes.

### 6.1.2 Biological

#### 6.1.2.1 Flora

The implications of the proposed development will be the removal of approximately 71 acres of vegetation, habitat loss for fauna and soil exposure. Based on the classification from the Flowering Plants of Jamaica (Adams, Proctor, and Read 1972), most species were either common or very common except for two species - *Calyptrothrix* sp and *Capparis babduca* (Appendix 5). *Calyptrothrix* sp. is endemic, however it is locally common and *Capparis babduca* is uncommon and found locally in St. Andrew, St. Catherine and St. Ann. No species was classified as endangered or protected. All species were checked against the International Union for Conservation of Nature (IUCN) red list. Only one species was listed - *Calyptrothrix* sp; however identification was only possible to the level of genus. It should be noted however, that all species of *Calyptrothrix* on the IUCN red list that are native to Jamaica were listed as vulnerable or endangered. Due to its low density and (2.3 stems per hectare) (Appendix 5) this species may be of little conservation significance in this area, even though species from this genus appear on the IUCN red list as vulnerable. *Capparis babduca* however, may be of some conservation significance; due to its high density (91 stems/hectare) and geographically confined to three parishes. It is likely that this area of St. Catherine is one in which it thrives; 91 stems per hectare equates to 2616 stems in 71 acres that potentially would be removed.

The floristic assessment concluded that the study area is of little vegetative conservation significance for the following reasons:

- Most species listed as common/ very common
- No species appear to be threatened or vulnerable (one possible exception)
- The area is highly disturbed and under continuously threat from anthropogenic sources; it will remain this way unless there is some intervention.

#### Recommended Mitigation:

- i. Based on the classification of *Capparis babduca* and the number of stems that will be removed, it is recommended that this species be replanted.
- ii. *Capparis babduca* could be used in the landscaping of the new development.

### 6.1.2.2 Fauna

Most direct impact is loss of habitat for observed species. The area is subject to continued high level of human activity; hence it is harsh and highly disturbed. Not surprisingly it supported only a very limited number of invertebrates, lizards and bird species; the species here are very tolerant of anthropogenic impacts and it is expected that these will continue to thrive in other suitable habitats.

#### **Recommended Mitigation:**

No mitigation available.

### 6.1.3 Human/Social/Cultural

#### 6.1.3.1 Employment

There is the potential for increased employment during the site clearance and construction phase. It is anticipated that approximately 18 persons will be employed directly for site preparation (e.g. excavator operator, bushing etc.), and 12 masons for vault preparation. It is anticipated that some labourers will be from sourced from nearby communities.

#### **Recommended Mitigation:**

No mitigation available.

#### 6.1.3.2 Traffic Management (Commuters and Pedestrians)

The construction process may necessitate the re-routing of some vehicular and pedestrian traffic and introducing traffic delays thereby increasing in travel time. Any re-routing of vehicular traffic has the potential to lead to increase fares. Increased accident potential from additional trucks traversing the main roads is also a possibility.

Negative impacts on traffic are expected during the construction stages, and these include:

- Disruptions in traffic.
- Reduced level of service due to increased large/construction vehicle on the roads.

Wear and tear on roads from loaded trucks transporting material and/or construction debris is also a cause for concern.

#### **Recommended Mitigation:**

During the site preparation and construction phases, the following should be enforced:

- i. Trucks should operate ideally during off peak hours.
- ii. Loading of trucks as per NWA axel load guidelines.
- iii. Traffic diversion routes must be identified and constructed as necessary.

- iv. Adequate caution signage as per NWA guidelines and the use of flagmen where necessary.
- v. Trucks must be properly covered and loaded so as to not let loose material fall during transport.

### **6.1.3.3 Cultural and Historical**

Taino occupation detected on and in the vicinity of the site is of importance. However, owing to dense vegetation cover, artefacts assemblage on the surface was not easily detected and an assessment in these areas was not possible. If significant artefacts are present in these areas, site clearance has the potential to negatively affect the archaeological heritage of the area.

#### **Recommended Mitigation:**

- i. During site clearance, JNHT should be present in order to undertake further archaeological evaluations and ascertain the magnitude of Taíno sites, if any.
- ii. Ensure the preservation of the historic and cultural sites.
- iii. Monitoring should be conducted during clearing and excavation stages in areas where historic artefacts were discovered.
- iv. The recording of impacted structures should be undertaken prior to destruction.

### **6.1.3.4 Aesthetics**

Solid waste generation during the construction period can have a potential negative impact on visual aesthetics if improperly collected and stored on site. There is also the potential for vermin infestation if discarded food and food containers are present.

#### **Recommended Mitigation:**

- i. Skips and bins should be strategically placed within the campsite and construction site.
- ii. The skips and bins at the construction campsite should be adequately designed and covered to prevent access by vermin and minimise odour.

## **6.2 OPERATION**

### **6.2.1 Physical**

#### **6.2.1.1 Noise Pollution**

Noise from vehicles attending funeral processions may have negative impact on the surrounding residential community. Also, there is a tendency for funeral processions to play loud music. Additionally, maintenance of cemetery grounds may include the use of a lawn mower, which may cause a noise nuisance to residents. However, maintenance will vary in locations on the property so any noise generated from lawnmowers will not be persistent.

Noise from excavators being used during vault construction may have a minor negative impact on surrounding residents.



**Recommended Mitigation:**

- i. Ensuring that equipment used are properly fitted with noise reduction devices such as mufflers.
- ii. Reduce unnecessary revving of vehicular engines.
- iii. No unnecessary honking of horns.
- iv. Institute guidelines as it relates to noise levels from loud speakers associated with funeral processions

**6.2.1.2 Air Pollution**

Emissions from lawnmowers used for maintenance and excavators used for vault construction have the potential to cause negative impact on surrounding residences.

**Recommended Mitigation:**

- i. Ensuring that equipment are properly maintained so as to reduce air emissions.

**6.2.1.3 Drainage**

Figure 4-20 in Section 4.1.4 (Topography and Morphology) shows the existing drainage in and around the property. The runoff coming out of the hills to the northwest and northeast of the development are channelized respectively by the Kitson Town main road and the unpaved Dovecot Cemetery road. The runoff channel along the unpaved Dovecot Cemetery road, the main drainage channel in the area, is reported to have caused flooding of the settlements along the road. The property however does not contribute runoff of any significance to this drainage channel and the proposed development is not likely to change that. There are no significant drainage channels traversing the property and, while there are several shallow closed depression on the property, there is no apparent problem with stagnant water either.

**Recommended Mitigation:**

No mitigation is required.

**6.2.1.4 Wastewater Generation and Disposal**

The groundwater may be polluted by wastewater should the wastewater be discharged to a drain or into the soil absorptive system.

**Recommended Mitigation:**

The evapotranspiration system recommended for this area is reasonably sized for the average weather conditions based on the available design data presented. It is recommended that detailed drawings and specifications be prepared prior to approval by EHU/WRA/NEPA for construction. The following items are critical to specify:

- The beds must be lined to prevent leakage of the wastewater.
- Specific plant types and spacing are required for the maximum uptake.

It is further recommended that an additional factor of safety be included in the design to account for extreme weather conditions, which in this case includes cool times when evaporation is low. This could include additional storage for up to one or two days when overflow of the system may occur.

#### **6.2.1.5 Solid Waste Generation**

Solid waste generation during cemetery operations will mainly include food and beverage refuse from funeral goers who purchase from any local vendors on the property. Biodegradable waste will include dead flowers/plants left on gravestones by visitors.

#### **Recommended Mitigation:**

- i. Garbage receptacles should be strategically placed around the cemetery grounds and along the access roads.
- ii. Garbage receptacles should be adequately designed and covered to prevent access by vermin and minimise odour.
- iii. Disposal of the contents of the skips/bins should be done at an approved disposal site.

#### **6.2.1.6 Natural Hazards**

##### **Hurricanes**

While the category of the hurricane gives an indication of its intensity and its damage potential, the actual impact of a hurricane on a specific site depends on many variables including the path of the hurricane, the location of the storm in relation to the site, the elevation of the site, the speed at which the eye of the storm moves and rainfall associated with the hurricane etc. The proposed development site is located 12 km inland at an average elevation of about 85 m A.M.S.L. With the exception of storm surges the site is overall exposed to the same hurricanes impacts as the rest of the island including gale force winds, high precipitation, flooding and erosion, disruption of essential services such as power, potable water, telephones, and access roadways

- Gale force winds can result in structural breaches of the building infrastructure (particularly lifting of roofs and destruction of windows and doors by airborne debris or missiles). If either a roof or window is damaged, it offers greater potential for further demolition of the building and for rain damage to property contained within.
- The exposure of the development to wind damage is relative low as the development only involves the construction and maintenance of a small number of buildings in support of the cemetery activities. The standard grave is below or at surface level and presents little or no exposure to the forces of the wind.
- Vegetation and signage will have the largest exposure to the forces of the wind. In a worst case scenario an uprooted tree may affect at most a few graves.

- Enclosed to the east and west by relative steep hillsides the development site is provided some shelter from the storm E-W moving Hurricanes, the prevailing track orientation of the average hurricane.
- Typically the storm systems are associated with heavy rainfall which may cause flooding. As discussed in the section on topography and morphology, the site has a good natural drainage system, defined by sheet flow, limited concentration of runoff on the property and an apparent free draining sinkholes system.
- The cemetery development is not expected to add many large hard surfaces which could significantly increase the runoff. In a worst case scenario some flooding of short duration may occur in the immediate vicinity of the sinkholes if the drainage capacity of the sinkhole #1 is exceeded by the runoff. It should be noted that flash flooding of the unpaved road Dovecot to the North East of the property can be expected in an extreme rainfall event but the proposed development will not significantly add to it.
- Erosion or scouring associated with heavy rainfalls is currently not an issue on the property. Even though erosion triggering activities like landscaping and excavation are part of the cemetery operations, it is not expected to become one.
- Loss of essential services will affect the operation of the cemetery in case of a major hurricane but do not pose any environmental hazard that cannot be prevented by applying standard operational procedures.

#### **Recommended Mitigation:**

Loss of essential services will affect the operation of the cemetery in case of a major hurricane but do not pose any environmental hazard that cannot be prevented by applying standard operational procedures.

#### **Earthquakes**

---

Some of the effects a major earthquake could have on the proposed development include:

- Structural damage to support building
- Toppled monument and smashed headstones. With the current trend to use small flat stones to mark the grave, this expected to be an insignificant impact.
- Cracked vaults exposing human remains
- Broken water pipes
- Toppled utility poles and downed power lines
- In an extreme earthquake event linear ground rupture resulting in vertical and horizontal displacement.

Liquefaction is not expected to be an issue here because of the high permeability of the red soils, the depth of the groundwater table and in the south-eastern section of the property the presence of rock

near the surface. Near the sinkholes a major earthquake could possibly cause the collapse of solution features and an equivalent subsidence at the surface.

**Recommended Mitigation:**

Though liquefaction is not expected to be an issue, a major earthquake could possibly cause the collapse of solution features and an equivalent subsidence at the surface in proximity of sinkholes. To mitigate for the risk it is recommended to maintain a buffer zone as was recommended in relation to the drainage. As a general recommendation the International Building Code, which has been incorporated in the local building code and which is expected to be enforced by the soon to be promulgated National Building Act, should be followed in the construction of the required infrastructure.

**6.2.1.7 Stormwater and Flooding**

The current drainage plan shows the storm water flows being channelled to the sinkholes onsite. Curb and channels will be employed to conduct the storm water generated both onsite and offsite to the sinkholes. The sinkholes and their immediate surroundings will remain in its present state with minimal landscaping for aesthetics. Special care will be taken not to restrict the sizes of the drains connecting the sinkholes. The improved drainage system onsite will conduct storm water more efficiently to the sinkholes and will cause less localized flooding in that vicinity.

Secondly, the curb and channels will be overwhelmed by the stormwater flow coming unto the site from the catchments above for severe storm events. The roads will receive the flows from the channels when they are overwhelmed and can sufficiently conduct the flows. It is at the discretion of the owners if this is acceptable given no funerals will be conducted during extraordinary events.

**Recommended Mitigation:**

In general, it is recommended that the final drainage design of the development maintains and conforms to the following main drainage features of the property:

- i. All runoff northeast of the limestone ridge should be directed to the sinkholes.
- ii. A drainage channel or swale should be maintained between sinkhole#2 and sinkhole#1.
- iii. No construction should take in the footprint of sinkhole #1 and #2 and in the footprint of the drainage channel between the two sinkholes.
- iv. No assessment has been done to ascertain the capacity of the sinkholes. The capacity of the sinkhole needs to be assessed to determine if it can accommodate the additional flows (both peak and total runoff) without flooding the site or nearby developments.
- v. It is recommended that sediment traps be installed in all drains leading to the sinkholes on the property to prevent them being blocked up over time.
- vi. Installation of berms and swale along the south-western border with the main road to prevent runoff entering the site from existing development. This flow will continue east and enter the gully system at the old racecourse south of the main road.



### 6.2.1.8 Pollution of the aquifer

#### Key Pollutants

It is a known fact that cemeteries tend to release contaminants into the soil and by extension the groundwater. As the bodies and caskets decompose, the contaminants are released gradually over time into the soil as water pass through the soil. The most vulnerable areas tend to be those with high rainfall and high water tables. Serious pollution can result where cemeteries are underlain by fractured rock and or high permeability soils. Several studies have indicated that the average human corpse of 70 kg contain several elemental components highlighted in Table 6-7.

Table 6-7 Typical elemental component of a 70kg human body. Source: (Environment Agency, 2004)

Elemental Component	Mass (g)
Oxygen	43000
Carbon	16000
Hydrogen	7000
Nitrogen	1800
Calcium	1100
Phosphorus	500
Sulfur	140
Potassium	140
Sodium	100
Chlorine	95
Magnesium	19
Iron	4.2
Copper	0.07
Lead	0.12
Cadmium	0.05
Nickel	0.01
Uranium	0.00009
Total body mass	70000

The pollutants derived from human corpses are found as dissolved and gaseous organic compounds and dissolved nitrogenous forms (particularly ammoniacal nitrogen). The biodegradability of the human has 60 percent being readily biodegradable, 15 percent moderately degradable, 20 percent slowly degradable and 5 percent inert. The decay process takes time (years) and the rate is typically dependent upon:

1. Drainage properties of the soil - well drained soils cause higher rates of decomposition
2. Depth of burial
3. Climate (temperature)
4. Availability of nutrients (carbon, nitrogen, phosphorus, sulphur) and moisture – the high water content of a corpse and the favorable carbon: nitrogen: phosphorus ratio in vertebrate bodies (about 30:3:1) encourages rapid and complete degradation of the corpse.

A human corpse normally decays within 10 to 12 years. It is estimated that over half of the pollutant load leaches within the first year and halves year-on-year. Less than 0.1 per cent of the original loading may remain after 10 years (see Table 6-8).

Table 6-8 Potential contaminant release (kg) from a single 70kg burial. Source: (Environment Agency, 2004)

Year	TOC	NH4	Ca	Mg	Na	K	P	SO4	Cl	Fe
1	6	0.87	0.56	0.01	0.05	0.07	0.25	0.21	0.048	0.02
2	3	0.44	0.28	0.005	0.025	0.035	0.125	0.11	0.024	0.01
3	1.5	0.22	0.14	0.003	0.013	0.018	0.063	0.054	0.012	0.005
4	0.75	0.11	0.07	0.001	0.006	0.009	0.032	0.027	0.006	0.003
5	0.37	0.05	0.03	0.001	0.003	0.004	0.016	0.012	0.003	0.001
10	0.01	<0.01	<0.01	<0.001	<0.001	<0.001	<0.001	<0.001	<0.001	<0.001

Additionally, bodies that have been embalmed will have formaldehyde concentrations starting concentration of 90mg/L in the first year and 0.1 in year ten.

### Groundwater Model Setup

#### 3-Dimensional Grid Setup

The grid approach was used to construct the simulation in a computational software model (MODFLOW in GMS). The grid approach involves working directly with the 3D grid and applying sources/sinks and other model parameters on a cell-by-cell basis. The files required to initialize the MODFLOW model include:

- a. Triangulated irregular network (TIN);
- b. Digital elevation model (DEM);
- c. Lithology and discharge of the wells.

The Limestone and alluvium aquifers were simulated using Five (5) layers in the computational grid. In order to simulate as accurate model as possible, the elevations of the top and bottom of each layer were made similar to the topographical and geological data in the wells lithology database obtained from the WRA.

The first step in setting up the MODFLOW model was to define the geology of the project area using the well lithology, represented by boreholes. Essentially, one (1) borehole was created for each well location. The spatially varying boreholes were 'related' or 'connected' through cross-sections in order to be interpolated as accurate as possible. A triangulated irregular network (TIN) was created from the digital elevation model (DEM) which facilitated in defining both the top and bottom elevations when creating the solids model. The TIN within the GMS software is represented as 3-D scatter points rather than a solid layer. Figure 6-2 illustrates the TIN created for the project area.

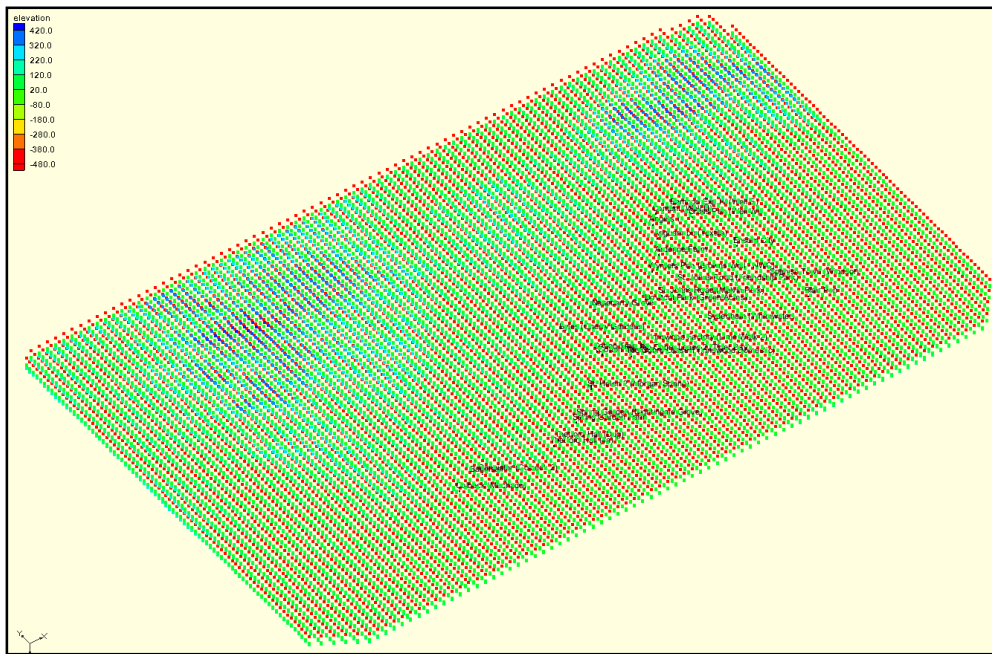
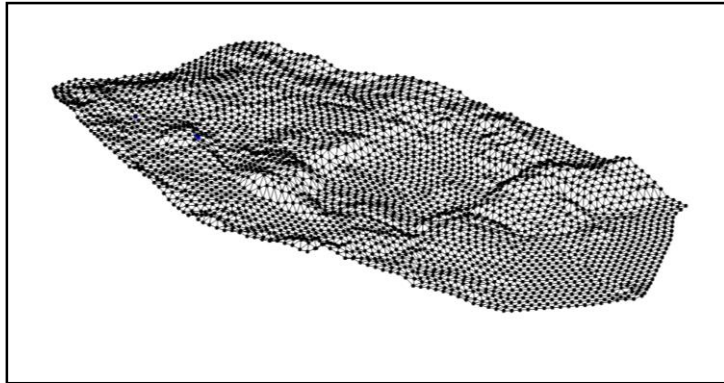

Figure 6-2 Triangulated Irregular Network (TIN) projected from the Digital elevation model (DEM)

A 3-dimensional solids model was then generated from the borehole data in conjunction with elevation data from the TIN. This solids model sets the foundation for running MODFLOW, MODPATH and MT3DMS as it depicts what is realistically in the field as accurate as possible.

The varying materials shown above were defined within the model, and their respective properties were defined within the model. These included but were not limited to horizontal and vertical conductivities and specific storage. Some of these properties are summarized below in Table 6-9. The hydraulic conductivity values shown vary depending on direction indicating anisotropic properties. For the vertical direction, some fraction of the horizontal hydraulic conductivity was used. Anisotropy is the property of being directionally dependent, as opposed to isotropy, which implies identical properties in all directions.

Table 6-9 Material properties implemented within the MODFLOW model

ID	Name	Horizontal k (m/d)	Vertical k (m/d)	Vertical Anisotropy (Kh/Kv)	Specific Storage (1/m)	Porosity
1	Limestone_D	260	232.90	1.12	0.1500	0.35
2	Limestone_P	274	232.90	1.18	0.1800	0.4
5	Sandy_Loam	2.99	2.24	1.33	0.3250	0.3
6	Limestone_Clay	137.06	75.38	1.82	0.1000	0.45
4	Sand	15.21	13.68	1.11	0.2500	0.3
7	Rock	8.64E-08	3.89E-08	2.22	1.57E-08	0.05
8	Flint	0.0600	0.0300	2	0.0109	0.3
3	Clay	0.1100	0.0110	10	0.0200	0.5
9	Bauxite	0.0004	0.0002	2	0.0003	0.2
10	Marl	0.0021	0.0010	2.08	0.0014	0.25
11	Gravel	259.20	220.32	1.18	0.2300	0.4
12	Top Soil (Loam)	0.6000	0.4500	1.33	0.4000	0.55
13	Sand_Clay	0.1874	0.0375	5	0.1350	0.35

**Model Calibration**

An important part of any groundwater modelling exercise is the model calibration process. In order for a groundwater model to be used in any type of predictive role, it must be demonstrated that the model can successfully simulate observed aquifer behaviour. Calibration is the process wherein certain parameters of the model such as recharge and hydraulic conductivity (k) were altered in a systematic fashion and the model was repeatedly run until the computed solution closely matches field-observed values (water table elevations obtained from well logs) within an acceptable level of accuracy.

The recharge values facilitated the calibration of the model through the analysis of current rainfall data. A 20-year climatological rainfall means (1992-2012 from the Met office of Jamaica) were evaluated and compared with the rainfall data obtained from WRA Master Plan; the WRA used slightly lower (<20%) precipitation values than calculated from the Met office data. The final recharge values used are summarized in Table 6-10 below.

Table 6-10 Recharge values used within the calibration of the MODFLOW model.

Hydrostratigraphy	Recharge suggested by WRA from Master Plan (m/d)	Recharge used in calibration (m/d)	Variance
Rio Cobre Aquifer	0.0010	0.0018	80%
Aquiclude	N/A	1.00E-06*	N/A

\*negligible



The hydraulic conductivity (k) values were also edited to simulate a more realistic head solution. The materials were assigned marginally greater k-values which translate to a more fluid movement through the layers of the grid for recharge and infiltration purposes.

The resultant head values were summarized in Table 6-11 below and compared against the observed values obtained from well logs. A graphical representation of the calculated head values is shown in Figure 6-3

Table 6-11 Comparison of observed head at selected wells versus heads determined by MODFLOW

<i>Well Name</i>	<i>Observed Water Elevation (m)</i>	<i>Calculated Head Values (m)</i>	<i>Variance</i>
Angels 1	17.36	20.00	13.2%
Ardenne Farm	5.73	20.40	71.9%
Ariguanabo	32.00	21.13	-51.4%
Bamboo (Well E)	19.26	20.65	6.8%
Bannister	12.77	17.92	28.7%
Bannister (Colbeck 2)	11.40	17.63	35.4%
Blair Pen	15.12	10.90	-38.7%
Byles (Cherry Gardens)	64.31	25.13	-156.0%
Colbeck (Machado)	3.54	18.06	80.4%
Content (Well H)	2.68	20.00	86.6%
Cotton Tree 2	13.81	12.50	-10.5%
Cross Pen (Well W)	0.32	16.44	98.0%
Dovecot Park (Green Acres)	15.77	20.30	22.3%
Ensom City	18.05	16.13	-11.9%
Innswood Factory (Lime Walk 2)	11.34	12.50	9.3%
Naseberry Grove	41.99	26.23	-60.1%
Rio Cobre Lease 1 (Innswood Domestic)	5.47	14.23	61.6%
Rio Cobre Lease 2 (Tiger Bay)	12.90	14.04	8.1%
Spanish Town (Windsor)	14.41	18.43	21.8%
Spring Garden (Nightingale Grove)	10.37	14.57	28.8%
Spring Garden Farm	14.89	14.28	-4.3%
St. Helen 2 (Morgan Spring)	4.82	12.50	61.5%
St. Johns Road (Friendship Park)	8.69	15.10	42.4%
St. Johns Road (Melvin Park)	8.63	20.00	56.8%
Sydenham (Whitewater)	11.09	18.96	41.5%
Thetford Hall (4a)	50.68	14.04	-261.0%
Thetford Hall (Dug)	6.13	14.06	56.4%
Wynters Pen (Browns Well - NWC)	35.84	20.76	-72.7%

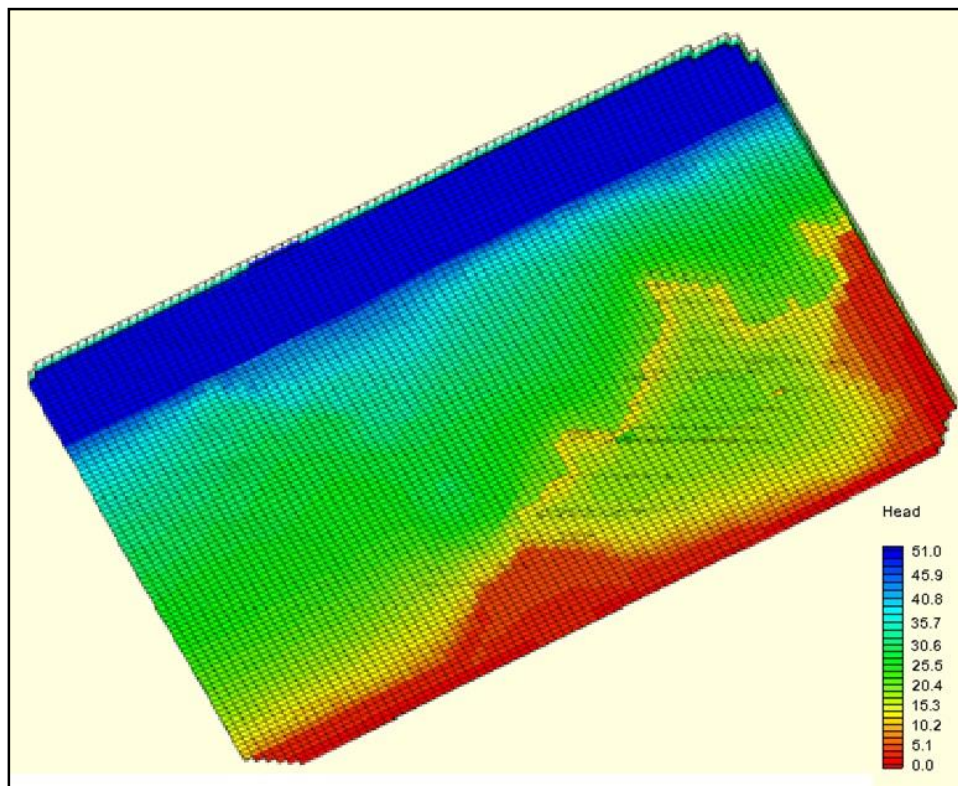

Figure 6-3 Calculated head values for the project area determined by MODFLOW

Essentially, using the solution of head values determined in the previous section, the areas within the aquifer which affect (recharges) the wells can be observed. This is represented in the form of pathlines (streamlines) originating from within the zone of influence and ending at the location of the wells themselves. Figure 6-4 displays the resultant pathlines associated with the wells in proximity to the proposed Dovecot development.

There are approximately twenty-nine (29) wells which are within 3 km of the proposed development. Based on the transient period of three hundred and sixty-five (365) days, the zone of influence of these wells was observed to extend as far north as the Bog Walk area. Due to the steep mountainous regions north of the wells, the groundwater that supplies the wells flow in a south-easterly direction towards the pumping location of the wells.

The lengths of each pathline indicate the transmissivity of the underlying soils which has definitive properties such as porosity and conductivity.

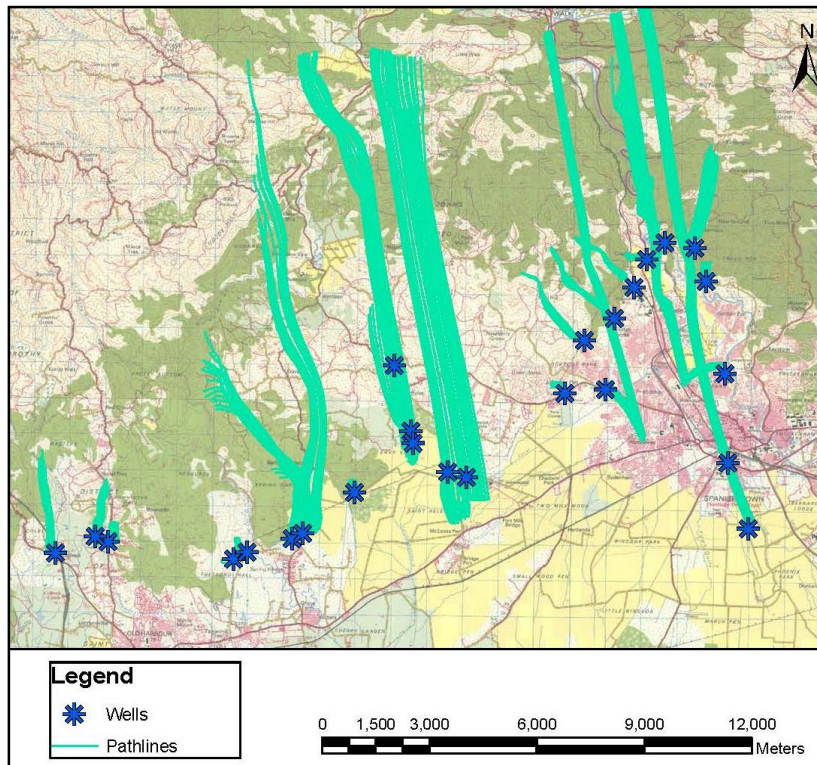

Figure 6-4 Zones of influence of the wells in proximity to the proposed development

The mechanisms and pathways through which diffuse pollutants from roads move through the environment are important considerations in planning and targeting prevention and control measures. An MT3DMS model was constructed in GMS using the grid approach to simulate both operational and accidental spill contamination. Since MT3DMS is a multi-species model, the number of species and name each species were appropriately defined. Ten (10) species as previously listed were used in modelling the groundwater contamination scenarios. The starting concentration array defines the initial condition for the contaminant concentration. For this project, the starting (background) concentrations were set to 0.01 mg/L, which is adequate for the project area.

Finally, we must define the data for the Source/Sink Mixing package. In this case, there exists only have one type of source/sink: the injection well. An injection well with the specified concentration provides the source of the contaminants. A pumping well serves to withdraw contaminated water migrating from the injection well. Both a transient flow solution and a transient transport simulation will be computed over a ten (10) year period.

MT3D relies on the MODFLOW solution files, hence, GMS gives MT3D the top and bottom elevation data it requires for each layer from the MODFLOW model.

Normal burials generally, on decomposition release heavy metals (Fe), nutrients (N, P) along with particulates (clay and soil particles) and other organic matter (dust, dirt, humus) into the soil.



The recharge from the rain was calculated using the 20-year rainfall averages for rainfall stations which are in proximity to the areas of interest. The rainfall data used in defining the surface runoff is summarized below in Table 6-12.

Table 6-12 Rainfall data for stations in proximity to project area

<i>Rainfall Station</i>	<i>AVERAGE (mm/yr)</i>
BYBROOK	1856.96
DAMHEAD	1266.63
TULLOCH ESTATES	1846.83
WAKEFIELD	1762.32
BOIS CONTENT	1488.66
BRIDGE PEN 1	800.60
BRIDGE PEN 3	808.24
HARTLANDS 1	1004.26
INNSWOOD 1 (Factory)	1303.84
INNSWOOD 2 (Cotton Tree)	1025.94
INNSWOOD 3 (McCooks)	876.86
ST. HELENS 3	891.13
WARWICK CASTLE (P.A.1)	1075.82
WARWICK CASTLE 2	929.58
WARWICK CASTLE 3	1095.88
BERNARD LODGE	1013.16
CAYMANAS NORTH	1003.62
GREAT SALT POND 2	710.35
MARCH PEN	878.01
PHOENIX PARK	907.40

### Model Prediction Results

#### Total Organic Carbon (TOC)

The background concentration used for the analysis was 0.01mg/L as historical information was lacking. The average estimated loading/concentration was 2,173 mg/L for TOC for each square meter of burial space at the project site. This is based on a typical scenario of one layer of graves being done in the first year within a burial plot. The concentration of the TOC entering the aquifer after the tenth year for that same plot is estimated at 2.02mg/L. The predicted concentration in the groundwater immediately surrounding the site is estimated at less than 1mg/L during the tenth year.

The areal extent of the contaminated plume is bounded by Naseberry Grove in the north, Innswood in the south, St. Johns Heights in the west and Friendship in the east after one (10) years of infiltration into the groundwater system. The movement of the pollutant plume is largely to the south east. It was observed that six (6) wells could be affected by the contamination of the groundwater by the cemetery;

these include Cotton Tree 1, Cotton Tree 2, Dovecot Park, St. Johns Road, Naseberry Grove and Rio Cobre Lease 2 (See Table 6-13).

Table 6-13 Affected wells and their respective contaminant concentrations after 10 years

Well Name	TOC (mg/L)
Cotton tree 1	0.00005
Cotton tree 2	0.00190
Naseberry	0.00164
Dovecot	0.70370
St Johns	0.01680
Rio Cobre 1	0.00150
Rio Cobre 2	0.01150

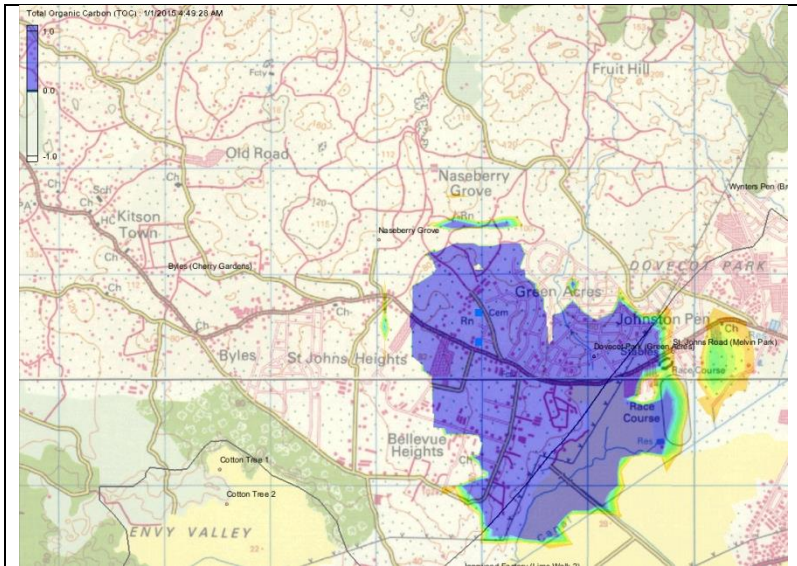

Figure 6-5 Operational TOC concentrations (1 year) due to runoff infiltrating project site.

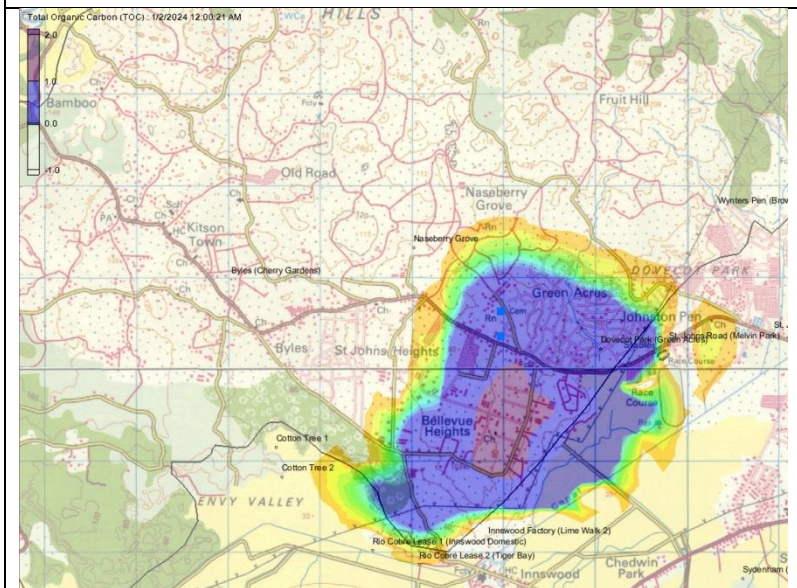

Figure 6-6 Operational TOC concentrations (10 years) due to runoff infiltrating project site.

### Ammonia

The background concentration used for the analysis was 0.0mg/L as historical information was lacking. The average estimated loading/concentration was 65.2 mg/L for ammonia for each square meter of burial space at the project site. This is based on a typical scenario of one layer of graves being done in the first year within a burial plot. The concentration of the TOC entering the aquifer after the tenth year for that same plot was estimated to be less than 0.74 mg/L. The predicted concentration in the groundwater immediately surrounding the site is estimated at between 6mg/L and 3mg/L during the first year. During the tenth year of operation the plumes from the same plot would have reduced concentrations of less than 1mg/L immediately around the site. These concentrations will continue to fall off thereafter as the decomposition phases of first year burials are completed.

The areal extent of the contaminated plume is bounded by Naseberry Grove in the north, Innswood in the south, St. Johns Heights in the west and Friendship in the east after one (10) years of infiltration into the groundwater system. The movement of the pollutant plume is largely to the south east. It was predicted that six (6) wells could be affected by the contamination of the groundwater from the cemetery; these include Cotton Tree 1, Cotton Tree 2, Dovecot Park, St. Johns Road, Naseberry Grove and Rio Cobre Lease 2 (See Table 6-14). These wells are on the outer fringes of the plumes where the concentrations are minimal (less than 0.091mg/L in all instances)

Table 6-14 Affected wells and their respective contaminant concentrations after 10 years

Well Name	NH <sub>3</sub> (mg/L)
Cotton tree 2	0.00024
Naseberry	0.00025
Dovecot	0.09049
St Johns	0.00216
Rio Cobre 1	0.00020
Rio Cobre 2	0.00015
Innswood Factory	0.00005



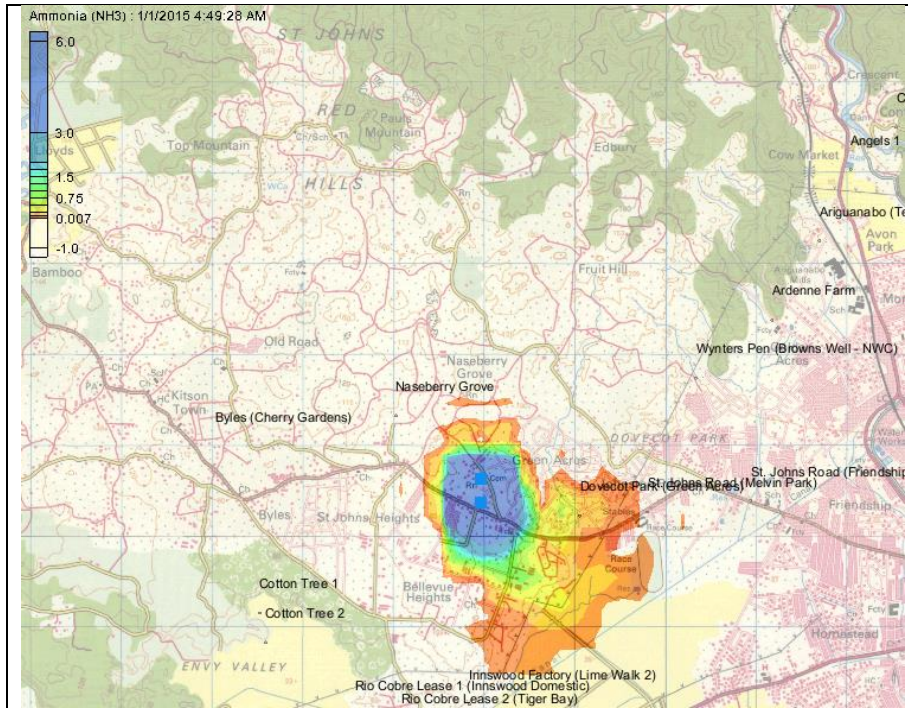

Figure 6-7 Operational NH3 concentrations (1 year) due to runoff infiltrating project site.

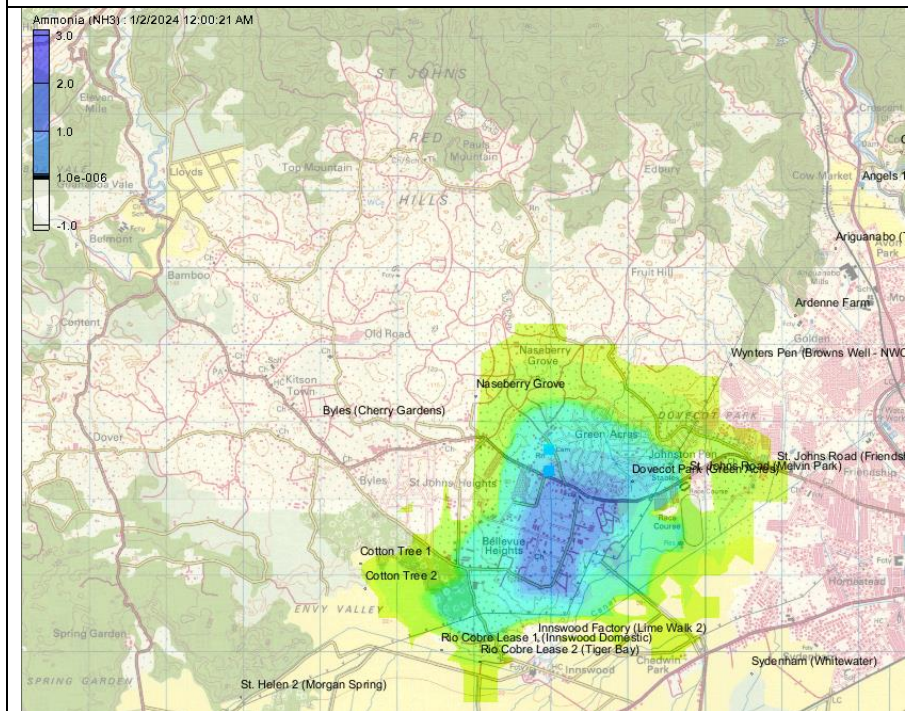

Figure 6-8 Operational NH3 concentrations (10 years) due to runoff infiltrating project site.

## Calcium

The background concentration used for the analysis was 96mg/L based on the historical data from the green acres well. The average estimated loading/concentration was 203 mg/L for calcium for each square meter of burial space at the project site. This is based on a typical scenario of one layer of graves being done in the first year within a burial plot. The concentration of the calcium entering the aquifer after the tenth year for that same plot was estimated to be less than 3.6 mg/L. The predicted concentration in the groundwater immediately surrounding the site is estimated at between 6mg/L and 31mg/L during the first year. During the tenth year of operation the plumes from the same plot would have reduced concentrations of less than 1mg/L immediately around the site. These concentrations will continue to fall off thereafter as the decomposition phases of first year burials are completed.

The areal extent of the contaminated plume is bounded by Naseberry Grove in the north, Innswood in the south, St. Johns Heights in the west and Friendship in the east after one (10) years of infiltration into the groundwater system. The movement of the pollutant plume is largely to the south east. It was predicted that seven (7) wells could be affected by the contamination of the groundwater from the cemetery; these include Cotton Tree 1, Cotton Tree 2, Dovecot Park, St. Johns Road, Naseberry Grove, Rio Cobre Lease 1 and Rio Cobre Lease 2. (See Figure 6-9 and Figure 6-10). These wells are on the outer fringes of the plumes where the concentrations are minimal (less than 0.091mg/L in all instances). The levels at the affected wells are predicted to be lower than the WHO drinking water standards or 200mg/L.



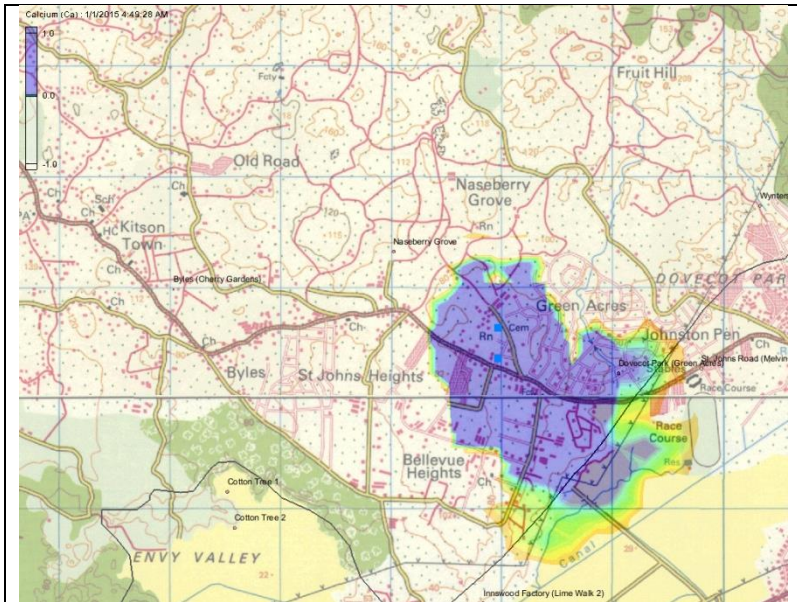

Figure 6-9 Operational Calcium concentrations (1 year) due to runoff infiltrating project site.

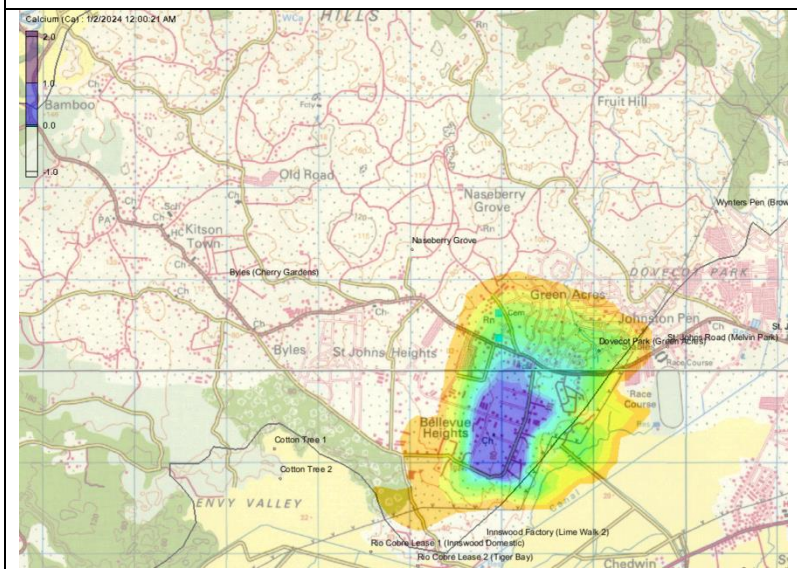

Figure 6-10 Operational Calcium concentrations (10 years) due to runoff infiltrating project site.

## **Magnesium**

The background concentration used for the analysis was 12mg/L based on the historical data from the green acres well. The average estimated loading/concentration was 3.62 mg/L for magnesium for each square meter of burial space at the project site. This is based on a typical scenario of one layer of graves being done in the first year within a burial plot. The concentration of the magnesium entering the aquifer after the tenth year for that same plot was estimated to be less than 0.36 mg/L. The predicted concentration in the groundwater immediately surrounding the site is estimated between 3.6mg/L and 1.2mg/L during the first year. During the tenth year of operation the plumes from the same plot would have decreased concentrations in the order of 0.67mg/L immediately around the site. These impacts of the cemetery leachate will continue to become even more negligible over time as the decomposition phases of first year burials are completed.

The impact of the cemetery on the magnesium levels in the nearby wells will be minimal in the medium to long term. The WHO guidelines standards calls for a limit of 150mg/L for safe drinking water whereas the background concentrations are in the order of 12mg/l and will be further reduced by the introduction of the cemetery leachate.

## **Sodium**

The background concentration used for the analysis was 9.7mg/L based on the historical data from the green acres well. The average estimated loading/concentration was 18.1 mg/L for sodium for each square meter of burial space at the project site. This is based on a typical scenario of one layer of graves being done in the first year within a burial plot. The concentration of the sodium entering the aquifer after the tenth year for that same plot was estimated to be less than 0.36 mg/L. The predicted increases in concentration immediately surrounding the site are negligible during the first to the tenth year of operation. These impacts of the cemetery leachate will continue to become even more negligible over time as the decomposition phases of first year burials are completed. Four wells are anticipated will be impacted by the increased sodium levels, they are the Dovecot well, St. Johns well and the Rio Cobre 1 and 2 wells.

## **Potassium**

The background concentration used for the analysis was 0.7mg/L based on the historical data from the green acres well. The average estimated loading/concentration was 25.4 mg/L for potassium for each square meter of burial space at the project site. This is based on a typical scenario of one layer of graves being done in the first year within a burial plot. The concentration of the potassium entering the aquifer after the tenth year for that same plot was estimated to be less than 0.36 mg/L. During the tenth year of operation the plumes from the same plot would have decreased concentrations in the order of 0.072mg/L immediately around the site. These impacts of the cemetery leachate will continue to become even less noticeable away from the site as well as overtime as the decomposition phases of first year burials are completed. Six wells are anticipated will be impacted by the increased potassium levels, they are the Dovecot well, St. Johns well and the Rio Cobre 2 well, Naseberry and Cotton tree 2 well.



### **Sulphate**

The background concentration used for the analysis was 0.0mg/L based on the historical data from the green acres well. The average estimated loading/concentration was 76.04 mg/L for sulphate for each square meter of burial space at the project site. This is based on a typical scenario of one layer of graves being done in the first year within a burial plot. The concentration of the sulphate entering the aquifer after the tenth year for that same plot was estimated to be less than 0.36 mg/L. The predicted increases in concentration immediately surrounding the site are negligible during the first to the tenth year of operation. During the tenth year of operation the plumes from the same plot would have decreased concentrations in the order of 0.298mg/L immediately around the site. These impacts of the cemetery leachate will continue to become even less noticeable away from the site as well as overtime as the decomposition phases of first year burials are completed.

Six wells are anticipated will be impacted by the increased potassium levels, they are the Dovecot well, St. Johns well and the Rio Cobre 1 and 2 wells, Naseberry and Cotton tree 2 well (Figure 6-11 and Figure 6-12).

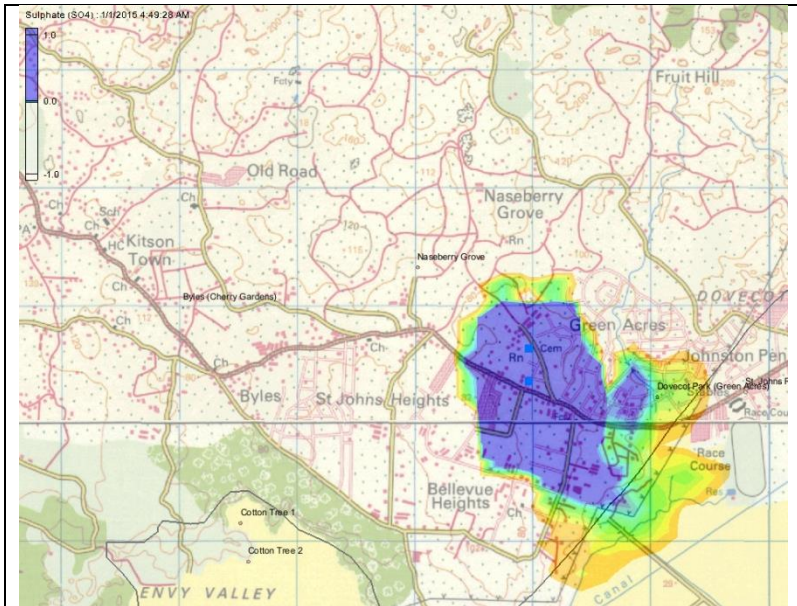

Figure 6-11 Operational sulphate concentrations (1 year) due to runoff infiltrating project site.

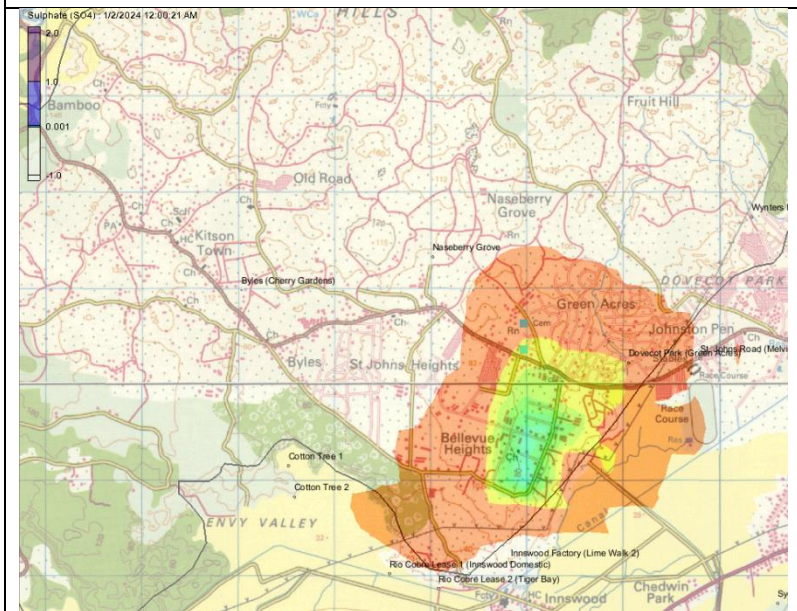

Figure 6-12 Operational sulphate concentrations (10 years) due to runoff infiltrating project site.

### Chlorine/Chloride

The background concentration used for the analysis was 18.0mg/L based on the historical data from the green acres well. The average estimated loading/concentration was 17.4 mg/L for chloride for each square meter of burial space at the project site. This is based on a typical scenario of one layer of graves being done in the first year within a burial plot. The concentration of the chloride entering the aquifer after the tenth year for that same plot was estimated to be less than 0.36 mg/L. The predicted increases in concentration immediately surrounding the site are minimal during the first to the tenth year of operation. The water quality entering the aquifer will begin to improve over time as the decomposition phases of first year burials are completed. The resulting concentrations will be well within the WHO standards for drinking water guidelines (of 250mg/L) when the wells in the area begin experience the impacts.

### Iron

The background concentration used for the analysis was 0.0mg/L based on the historical data from the green acres well. The average estimated loading/concentration was 7.2mg/L for Iron for each square meter of burial space at the project site. This is based on a typical scenario of one layer of graves being done in the first year within a burial plot. The concentration of the Iron entering the aquifer after the tenth year for that same plot was estimated to be less than 0.36 mg/L. The predicted increases in concentration immediately surrounding the site are negligible during the first to the tenth year of operation. The impacts of the cemetery leachate will continue to become even more negligible over time as the decomposition phases of first year burials are completed. The resulting concentrations are negligible and well within the WHO standards (of 0.3mg/L) for drinking water when the wells in the area begin experience the impacts. At the end of the simulation (10<sup>th</sup> year), the concentration immediately around the site was predicted to be 0.001 mg/L. Three wells are anticipated will be impacted by the increased iron levels, they are the Dovecot well, St. Johns well and the Rio Cobre 2 well (Figure 6-13 and Figure 6-14).

Table 6-15 Affected wells and their respective contaminant concentrations after 10 years

Well Name	Fe (mg/L)
Dovecot	0.00174
St Johns	0.00006
Rio Cobre 2	0.00004

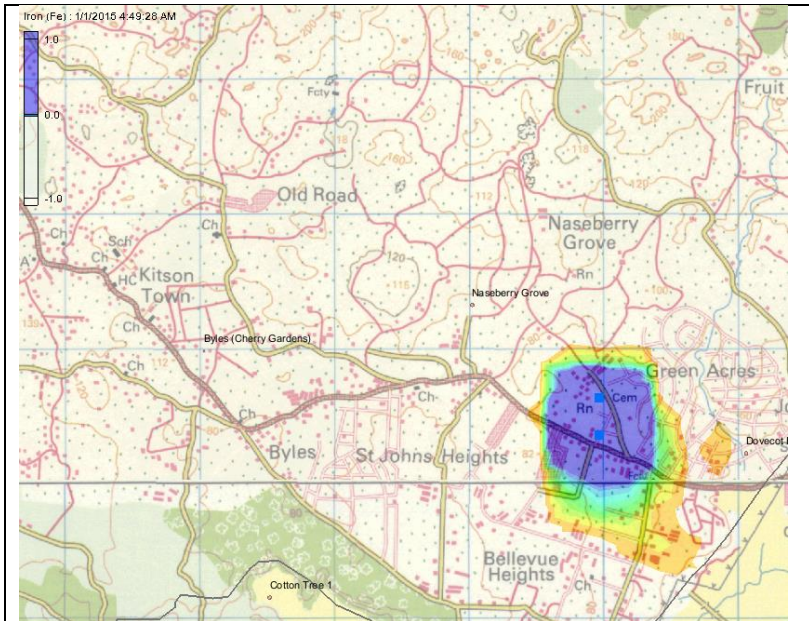

Figure 6-13 Operational iron concentrations (1 year) due to runoff infiltrating project site.

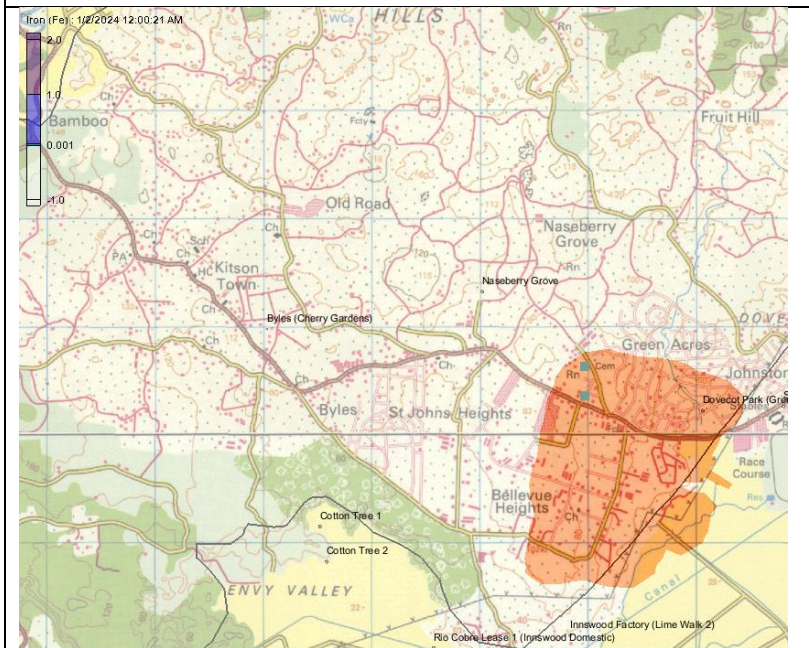

Figure 6-14 Operational iron concentrations (10 years) due to runoff infiltrating project site.



## Phosphorus

The background concentration used for the analysis was 0.0mg/L based on the historical data from the green acres well. The average estimated loading/concentration was 90.53mg/L for phosphorous for each square meter of burial space at the project site. This is based on a typical scenario of one layer of graves being done in the first year within a burial plot. The concentration of the phosphorous entering the aquifer after the tenth year for that same plot was estimated to be less than 0.36 mg/L. The predicted increases in concentration immediately surrounding the site are in the order of 2.0mg/L to 0.2mg/L respectively during the first to the tenth year of operation. The impacts of the cemetery leachate will continue to become even more negligible over time as the decomposition phases of first year burials are completed. Seven wells are anticipated will be impacted by the marginal increases phosphorous levels, they are the Dovecot well, St. Johns well, the Rio Cobre 1 and 2 wells, Cotton tree 2 and Innswood Factory well (Figure 6-15 and Figure 6-16).

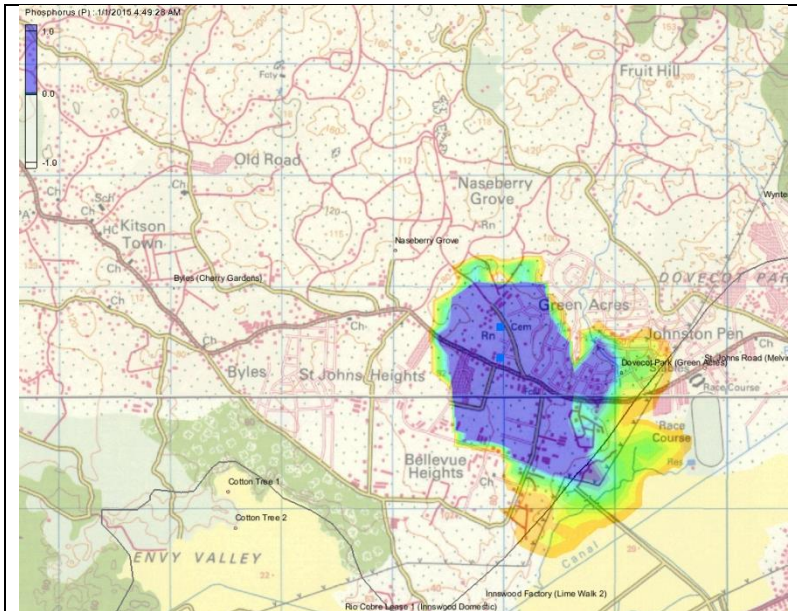

Figure 6-15 Operational phosphorus concentrations (1 year) due to runoff infiltrating project site.

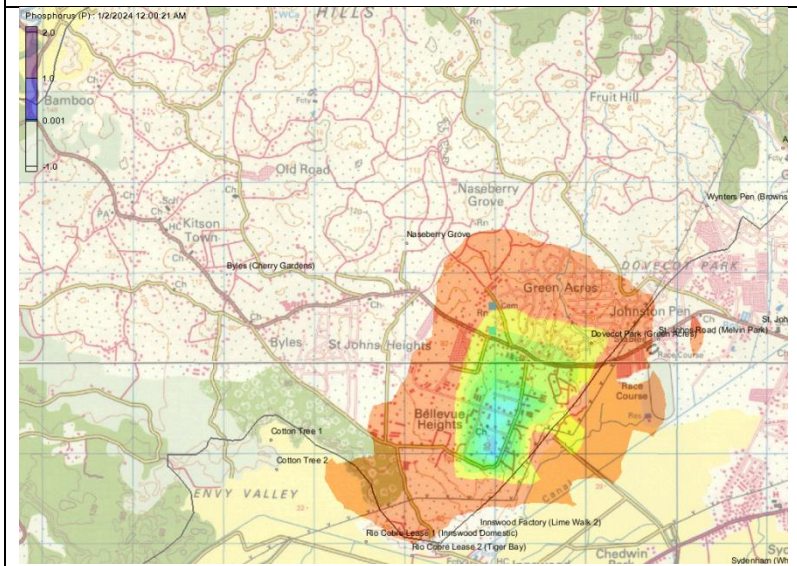

Figure 6-16 Operational phosphorus concentrations (10 years) due to runoff infiltrating project site.

**Recommended Mitigation:**

- i. Minimize the use of chemicals in embalming and coffin preparation.
- ii. Encouraging more green burials.
- iii. Encourage more cremation and possibly prepare a location onsite for storing urns.

- iv. Have monitoring wells to the south and southeast of the property to monitor the water quality during the operational phase of the development. This should guide the rate at which the development proceeds over time.

According to the WHO, 1998;

- i. Human or animal remains must not be buried within 250 metres of any well, borehole or spring from which a potable water supply is drawn.
- ii. The place of interment should be at least 30 metres away from any other spring or watercourse and at least 10 metres from any field drain.
- iii. All burial pits on the site must maintain a minimum of one metre of subsoil below the bottom of the burial pit (i.e. the base of the burial must be at least one metre above solid rock).
- iv. The base of all burial pits on the site must maintain a minimum of one metre clearance above the highest natural water table. (Any variability in the water table should be taken into account.)
- v. Burial excavations should be backfilled as soon as the remains are interred, providing a minimum of one metre soil cover at the surface.

#### **6.2.1.9 Wastewater Generation**

It is anticipated that the production of wastewater will be primarily domestic, i.e. from the bathrooms. The generation of the wastewater will be primarily from the staff and daily visitors attending funerals in the park. The estimated total wastewater flows to be generated is therefore in the order of 20.9 m<sup>3</sup>/day.

#### **Recommended Mitigation:**

- i. Ensure that the wastewater collection and treatment system as outlined in the document or approved by the Agency is implement

#### **6.2.1.10 Water Usage**

It is anticipated that water demand will come from two main sources, these are the bathrooms/showers and the irrigation areas. The estimated water demand is based on a per capita usage by staff (30) and an estimated 1000 visitors per day as well as the irrigation requirements per acre for grass (California State Water Resources Control board, 1984). The total required volume of water required per day is estimated at 1,334m<sup>3</sup>/d on average when the full 12 phases are realized.

#### **Recommended Mitigation:**

- i. Use low flow faucets and toilets.
- ii. As far as possible irrigate during early morning or afternoons.
- iii. Use drip irrigation where possible.

## 6.2.2 Biological

### 6.2.2.1 *Habitat Loss*

The existing site vegetation may potentially be replaced by an artificial landscape composed mainly of grass and a few tree and shrub species. This may potentially reduce the type as well as availability of habitat for fauna currently utilizing the proposed site. That is, a potential overall reduction in suitable/available habitat for birds (resident and migratory), insects, reptiles and cattle.

### 6.2.2.2 *Species Loss and Reduction in Biodiversity*

The study site consists of a highly disturbed composition of flora and fauna. However, this may potentially be further reduced by project operations. There is potential for an overall reduction in the biodiversity of the area, that is, reduced species diversity, abundance and density. Several plant and animal species may be removed completely from the area.

### 6.2.2.3 *Habitat Fragmentation*

The resultant habitat from the project may potentially be fragmented by roadways and other infrastructure. A more pronounced fragmentation may be seen as the project area as a whole fragmenting the surrounding areas from one another. This may be particularly important for species that avoid open areas in flight or along other access routes. This may include birds, bats and reptiles.

### 6.2.2.4 *Increased Competition*

There may be potential increased competition amongst both plant and animal species in the surrounding undeveloped areas. The reduction in available suitable habitat may potentially cause increased interspecies competition which may result in the loss/reduction of certain floral and faunal species.

## 6.2.3 Human and Social

### 6.2.3.1 *Employment*

Although cemetery operations are not a labour intensive business, there is the potential for employment during the operation phase. There exists opportunities for landscapers and local business/vendors may get additional patronage from persons in funeral processions. It is anticipated that approximately 18 persons will be employed directly for site preparation (e.g. excavator operator, bushing etc.) and 12 masons for vault preparation.

Additional burial capacity

It has become critical to expand the existing Dovecot Memorial Gardens as the current area used for burials has run out of space. Customers are complaining that due to the limited space available they are not able to choose a location that they deem ideal for their loved ones and funerals are in too close a proximity.



### 6.2.3.2 *Aesthetics*

The sight of a cemetery can become visually unappealing to passers-by.

#### **Recommended Mitigation:**

The cemetery grounds should be landscaped continually to enhance the feeling of serenity for mourning family members and friends attending funerals or visiting graves. Any large trees present in suitable areas (that will not interfere with vault areas) on site should remain so as to provide shading and improve overall aesthetics of the grounds. In this regard, *Capparis babduca* and existing shade trees should be used along with grass to landscape the grounds. Consideration should be given to earthen grave finishes with headstones or commemorative tree rather than the traditional concrete slabs.

## 7.0 CUMULATIVE ENVIRONMENTAL IMPACTS

### 7.1 POST-DEVELOPMENT

#### 7.1.1 Extreme Rainfall Runoff

The 24-hour rainfall data for approximately 250 gauges across Jamaica were obtained from the Meteorological Office of Jamaica. Information for the gauges spanned 1930 to 1980 and 1992 to 2008. Both sets of data were subjected to Weibull analysis for the extreme rainfall data ranging for the 2, 5, 10, 25, 50 and 100 year. Historical rainfall extremes for stations across the island for the period 1930 to 1988 were compared with the extremes determined for the period 1992 to 2008. Rainfall depths for corresponding return periods were subjected to comparative analysis in order to determine if there was an overall increase or decrease in extreme rainfall.

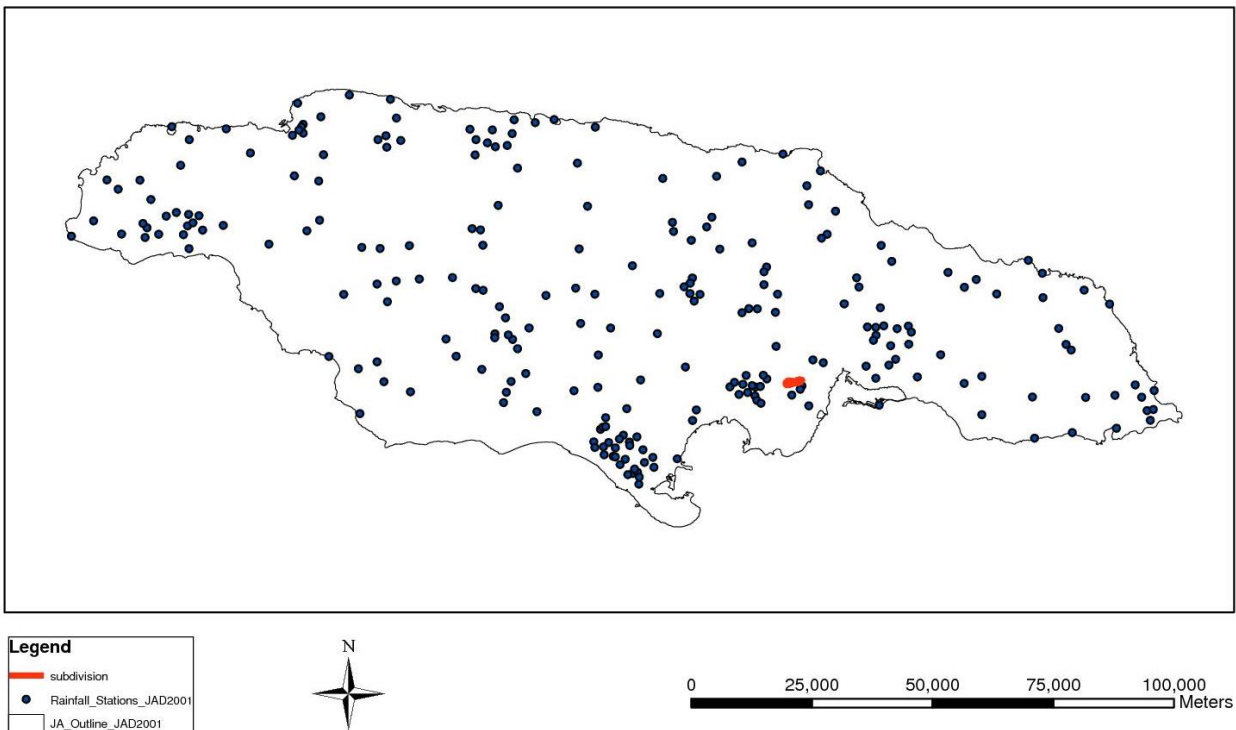

Figure 7-1 Locations of Rainfall stations obtained from Met office of Jamaica

The analysis indicates that there has been an overall increase ranging from 11.7% (for the 2 year Return Period Event) to 1.5% (for the 100 year Return Period event) for all stations. This increase has occurred over a time frame of 21 years (1988 to 2009). This equates to 0.7% to 5.6% increase per decade. See Table 7-1 and Figure 7-2 below.

Table 7-1 Overall increase in 24-hours rainfall intensity for the period between 1988 and 2009

	Return Period (yr)					
	2	5	10	25	50	100
Number of stations considered	117	117	117	117	117	116
Average increase (mm)	14.0	10.0	5.6	5.9	6.3	5.3
Average rainfall depth (mm) 1930 to 1988	119.8	175.0	217.7	268.2	307.8	345.7
Overall increase	11.7%	5.7%	2.6%	2.2%	2.1%	1.5%
Increase per decade	5.6%	2.7%	1.2%	1.0%	1.0%	0.7%

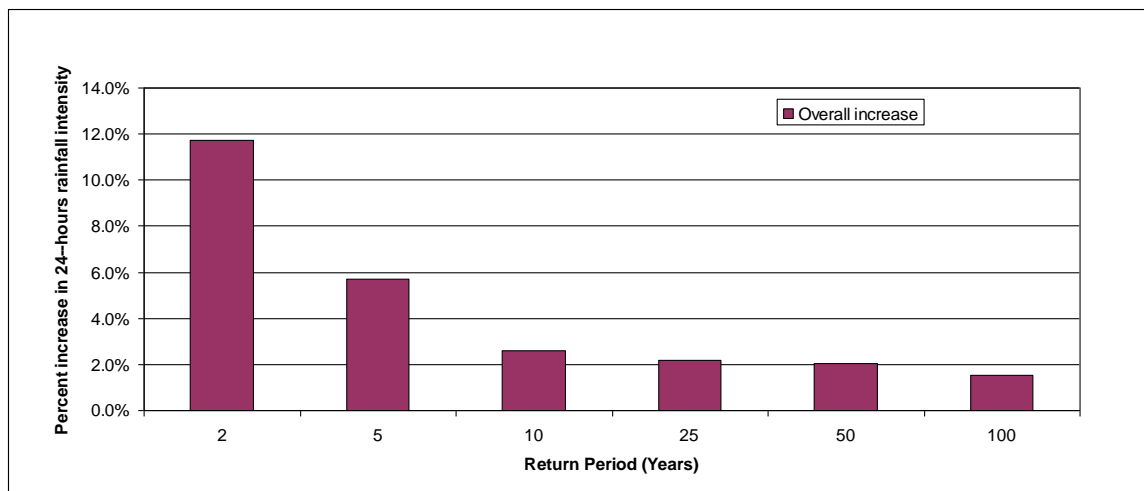

Figure 7-2 Overall increase in 24-hours rainfall intensity for the period between 1988 and 2009

Given the design life of the project over 48 years, due consideration should be given to the changes in extreme rainfall as the old data appears to be irrelevant in light of the new data supplied by the Met office of Jamaica.

The development of the hillsides as well as more intense rainfall events will increase runoff coming unto the site in the future. Due consideration should be given to improving existing drainage system and making allowances onsite for the flows getting to the sinkholes as seamless as possible.

### **7.1.2 Groundwater Quality**

The groundwater quality in the vicinity of the cemetery will be minimally impacted in the long term as bodies progressively degrade. The cemetery is however predicted to operate over 48 years and so the ground water quality will be impacted for a much longer period as bodies are continuously buried throughout that time period.

### **7.1.3 Transportation**

The additional funeral processions/convoys will result in vehicular engine noise, exhaust emissions and wear and tear on existing main roads in the area (Kitson Town Main Road and St. Johns Road).



## 8.0 RESIDUAL IMPACTS

Section 6.0 (Identification and Assessment of Potential Direct and Indirect Impacts and Recommended Mitigation) described the potential impacts that would occur as a result of different phases of the project and how the proposed mitigation measures would contribute to minimising or eliminating the impacts. Not all impacts can be fully mitigated and therefore residual impacts will be experienced by the environmental and social receptors affected by the project. These are discussed below.

### 8.1 SITE PREPARATION AND CONSTRUCTION

#### 8.1.1 Air Quality

Fugitive dust and emissions from machinery and equipment have the potential to affect the health of construction workers and the resident population. Both types of impacts will be of low intensity and of relatively short duration.

#### 8.1.2 Traffic

Project construction activities may introduce traffic delays thereby increasing the travel time. Negative impacts on traffic are expected during the construction stages, including reduced level of service in the areas around the proposed site due to increased large/construction vehicles on the roads (Kitson Town Main Road and St. Johns Road).

#### 8.1.3 Heritage and Cultural

The proposed project area has dense vegetation cover. When this vegetation is removed from the proposed site, there is the probability of finding historic and cultural material. There is the possibility that they may be destroyed by heavy machinery and equipment during the site clearance process.

### 8.2 OPERATION

#### 8.2.1 Noise

The proposed project has the potential to be a noise nuisance during both the construction and the operation phases. Even with the proper mitigative steps, short-term noise impacts of varying duration (such as mowing of lawns) will be a nuisance to surrounding residential communities.

#### 8.2.2 Groundwater Quality

The groundwater quality in the vicinity of the cemetery will be minimally impacted in the long term as bodies progressively degrade. In addition, increased suspended solid content, turbidity and oils and grease from stormwater channelled into the sinkholes will result in water quality degradation of the sinkholes.

## 8.2.3 Socio-Economic

### 8.2.3.1 *Unmet Employment Expectations*

Because of the high unemployment rate in the area and in the island in general, residents in directly affected communities who are unsuccessful in securing a job are likely to become frustrated when they do not gain employment on the proposed project. This could create resentment and possibly hostility towards those who are successful in getting jobs, and even towards the Developer. The possibility also exists that there will be resentment towards the Developer arising from perceptions of bias in the recruitment process.

### 8.2.3.2 *Accidents involving community members*

The possibility exists that accidents involving community members will occur at some stage during project construction. This could be traffic-related, or other accidents. A residual impact is created in terms of diminishing the standard of living for a person, negatively impacting his or her household.

## 9.0 IDENTIFICATION AND ANALYSIS OF ALTERNATIVES

The following project alternatives have been identified and are discussed in further detail below:

- Alternative 1 - The “No-Action” Alternative
- Alternative 2 - The Project as Proposed
- Alternative 3 – Use of Proposed Site for Residential Purposes
- Alternative 4 - Use of Proposed Site for Building a School
- Alternative 5 - Use of Proposed Site for Cattle Rearing
- Alternative 6 - Relocation of the Proposed Expansion to the North of the existing Dovecot Cemetery

### 9.1 ALTERNATIVE 1 – THE “NO-ACTION” ALTERNATIVE

Under the No-Action Alternative, the lands will remain as highly disturbed vegetation dominated by shrubs and saplings. Additionally, the area will continue to be used as an informal dump. There will thus continue to be a shortage of burial spaces to supplement the parish capacity. To be able to implement the No-Action Alternative, the government would have to purchase the lands from the landowner (Kumanda Park Ltd.).

### 9.2 ALTERNATIVE 2 – THE PROJECT AS PROPOSED

The project as proposed is located in Chisholm Bendon Pen, St. Catherine and is situated about 80 meters above sea level, approximately 500 metres west of the current Dovecot Memorial Park, a kilometre north of Bellevue Heights, about 6.5 kilometres west from Spanish Town along St. Johns Road and contiguous to Naseberry Grove to the south. It is intended that the 71 acre (28.7 hectares, 0.29 km<sup>2</sup>) property is to be developed to accommodate 48,120 burial vaults (≈ 15.7 ha) and sanitary facilities (225 m<sup>2</sup>). With a land area of 28.7 ha, the burial density is 1,676.65 vaults per hectare. The existing Bendon Seventh Day Adventist church will remain and 17,520 m<sup>2</sup> of internal road ways will be put in place as the main artery of the property.

All the public cemeteries in St Catherine have reached or almost reached their capacities. It has therefore become critical for additional burial spaces for the parish before the cemeteries become filled to their capacities. It has also become critical to expand the existing Dovecot Memorial Gardens as the current area used for burials has run out of space. Customers are complaining that due to the limited space available they are not able to choose a location that they deem ideal for their loved ones and funerals are too close together in proximity.

The proposed Alternative will include the following advantages:

- Increased burial capacity to supplement the parishes of Kingston, St. Andrew and St. Catherine.
- Although cemetery operations are not labour intensive, jobs will be created during the construction and operation periods. In addition, vendors who sell refreshments in the area will be patronized during funeral processions.
- Preventing the proposed area to be used as an informal dump or informal housing area “squatter area”.

Main consideration in site selection include:

- The site is owned by the proposed developers.
- The site is easily accessible.
- There were no major issues related to environmental sustainability; and
- The development would not breach any Development Order guidelines.
- It is in keeping with the criteria in the Development and Investment Manual that there should be approximately 40 hectares for every 100,000 population.

Disadvantages include;

- Habitat loss for flora and fauna
- Loss of income for persons whose livelihoods depend on the proposed project site for charcoal burning activities and animal husbandry.
- Potential contaminants affecting groundwater quality.

### 9.3 ALTERNATIVE 3 – USE OF PROPOSED SITE FOR RESIDENTIAL PURPOSES

This alternative speaks to using the proposed lands for construction of residential units such as apartment complexes, townhouses or gated subdivisions.

The proposed Alternative will include the following advantages:

- Increased housing for persons.
- Increased employment during construction.
- Preventing the proposed area to be used as an informal dump or informal housing area “squatter area”.

Disadvantages include:

- Continued shortage of burial spaces to supplement the parish capacity.
- Larger generation capacity for sewage, solid waste, noise emissions and traffic.
- Greater demand for water resources, electricity, road maintenance and social amenities such as schooling, hospitals, police etc.



## 9.4 ALTERNATIVE 4 – USE OF PROPOSED SITE FOR BUILDING A SCHOOL

This alternative speaks to using the proposed lands for construction of educational facilities whether primary, secondary, tertiary or vocational institutions.

The proposed Alternative will include the following advantages:

- Increased number of educational facilities in the area.
- Increased employment for persons in the area during construction.
- Preventing the proposed area to be used as an informal dump or informal housing area “squatter area”.

Disadvantages include:

- Continued shortage of burial spaces to supplement the parish capacity.
- Habitat loss for flora and fauna.
- Close proximity to residential areas resulting in potential noise disturbance.
- Loss of income for persons whose livelihoods depend on the proposed project site for charcoal burning activities and animal husbandry.

## 9.5 ALTERNATIVE 5 – USE OF PROPOSED SITE FOR CATTLE REARING

The proposed Alternative will include the following advantages:

- Increased employment for persons in the area.
- Preventing the proposed area to be used as an informal dump or informal housing area “squatter area”.

Disadvantages include:

- Continued shortage of burial spaces to supplement the parish capacity.
- Close proximity to residential areas resulting in noise and odour nuisance.
- Habitat loss for flora and fauna.

## 9.6 ALTERNATIVE 6 – RELOCATION OF PROPOSED EXPANSION TO THE IMMEDIATE NORTH OF THE EXISTING DOVECOT CEMETERY

This alternative speaks to relocating the proposed cemetery expansion to the immediate north of the existing Dovecot Memorial Gardens cemetery.

The proposed Alternative will include the following advantages:

- Jobs will be created during the construction and operation periods. In addition, vendors who sell refreshments in the area will be patronized during funeral processions.

- Preventing the proposed area to be used as an informal dump or informal housing area “squatter area”.

Disadvantages include:

- Land is not owned by the developers.
- Land gets steeper moving further north. Sloping land is a deterrent to choosing the ideal burial location.
- Smaller lots (2 hectares each) to the immediate northwest of the existing Dovecot cemetery. The developer would have to purchase at least 14 of these lots (each with different owners) to equate to the proposed 28.7 hectares, if they were available for sale.
- According to the WRA Hydrogeological Assessment Technical Note (Appendix 6), *“the proposed cemetery should be sited in areas having a thick soil layer for the burial pits to maintain a minimum of 1m of unsaturated subsoil/alluvium below the bottom of the burial pit before encountering bedrock and minimum of 1m soil cover at the surface.”* Lands to the north of the proposed site have more bedrock outcroppings therefore making the probability higher for non-compliant with the WRA Technical Notes.

## 9.7 THE PREFERRED ALTERNATIVE

The preferred alternative is Alternative 2 – The Project as proposed, because of the need for increased burial capacity to supplement the parishes of Kingston, St. Andrew and St. Catherine. The proposed site is also easily accessible, is owned by the developer and is in keeping with the criteria in the Development and Investment Manual and the WRA Hydrogeological Assessment Technical Note.

## 10.0 ENVIRONMENTAL MONITORING AND MANAGEMENT

It is recommended that several parameters be monitored before, during and after the project implementation to record any negative construction impacts and propose corrective or mitigative measures. The suggested parameters include the following:

1. Water quality to include but not be limited to:
  - pH
  - Electrical conductivity
  - Turbidity
  - Total Suspended solids (TSS)
  - Nitrates and Phosphates
  - Faecal Coliform
  - Grease and Oils
2. Noise
3. Dust
4. Traffic

### 10.1 SITE CLEARANCE AND PREPARATION PHASE

- Daily inspections to ensure that site clearance and preparation activities are not being conducted outside of regular working hours (e.g. 7 am – 7 pm). In addition, a one off noise survey should be undertaken to determine workers exposure and construction equipment noise emission. Project engineer / construction site supervisor should monitor the construction work hours. NEPA should conduct spot checks to ensure that the hours are being followed.
- Daily monitoring to ensure that the activity is not creating a dust nuisance. Project engineer / construction site supervisor should monitor the site clearance. Particulate measurements should be taken especially during the excavation and filling activity and compared with the baseline data outlined in this report to ensure that residents or workers are not being exposed to excessive dust. NEPA should conduct spot checks to ensure that this stipulation is followed.
- Background readings should be taken of all water quality parameters prior to construction. Readings should be conducted monthly, prior to construction, upstream and downstream of the anticipated impact zone.
- Undertake daily inspections of trucks carrying solid waste generated from site clearance activities to ensure that they are not over laden as this will damage the public thoroughfare and onsite lead to soil compaction. Person(s) appointed by the Project Manager may perform this exercise.
- Daily monitoring of vehicle refuelling and repair should be undertaken to ensure that these exercises are carried out on hardstands. This is to reduce the potential of soil contamination

from spills. Spot checks should be conducted by NEPA. Person(s) appointed by Project Manager may perform this exercise.

## 10.2 CONSTRUCTION PHASE

- Daily inspection of site clearance activities to ensure that they are following the proposed plan and to ensure that site drainage system are not impacting on any waterways. Check and balance can be provided by NEPA and the St. Catherine Parish Council. Person(s) appointed by Project Manager may perform this exercise.
- Undertake monthly water quality monitoring or a frequency agreed to with NEPA to ensure that the construction works are not negatively impacting on water quality. The parameters that should be monitored are salinity, dissolved oxygen, nitrates, phosphates, turbidity, total suspended solids and faecal coliform. Any organization with the capability to conduct monitoring of the listed parameters should be used to perform this exercise. It is recommended that a report should be given to NEPA at the end of each monitoring exercise.
- Daily inspections to ensure that construction activities are not being conducted outside of regular working hours (e.g. 7 am – 7 pm). In addition to noise environmental noise monitoring noise survey should be undertaken to determine workers exposure and construction equipment noise emission. Noise monitoring to be conducted monthly at the site and settlements near to site. Project engineer / construction site supervisor should monitor the construction work hours. NEPA should conduct spot checks to ensure that the hours are being followed.
- Daily monitoring to ensure that fugitive dust from cleared areas, access roads and raw materials are not being entrained in the wind and creating a dust nuisance. Particulate measurements should be conducted monthly. Project engineer / construction site supervisor should monitor the construction work hours. NEPA should conduct spot checks to ensure that this stipulation is being followed. In addition, any Citizens Association within the area can be used to provide additional surveillance.
- Undertake daily inspections of trucks carrying raw material to ensure that they are not over laden as this will damage the public thoroughfare and onsite lead to soil compaction. Person(s) appointed by the Project Manager may perform this exercise.
- Conduct daily inspections to ensure that trucks carrying raw materials and heavy equipment are parked at the designated area on the proposed site so as to prevent traffic congestion along existing roads. Person(s) appointed by the Project Manager may perform this exercise.
- Conduct daily inspections to ensure that flagmen where necessary are in place and that adequate signs are posted along the roadways where heavy equipment interact with existing roads. This is to ensure that traffic have adequate warnings and direction. Person(s) employed by the Project Manager may perform this exercise.
- Undertake daily assessment of the quantity of solid waste generated and keep records of its ultimate disposal. Additionally, solid waste generation and disposal of the campsite should also be monitored. Person(s) appointed by the Project Manager may perform this exercise.



- Weekly assessment to determine that there are adequate numbers of portable toilets and that they are in proper working order. This will ensure that sewage disposal will be adequately treated. Person(s) appointed by the Project Manager may perform this exercise.
- Monitor and approve the suppliers and sources of local materials. Inspection of the quarries should be conducted to ensure that they are legal. Copies of these licences should be kept on file. Person(s) appointed by Project Manager may perform this exercise.
- Daily monitoring of vehicle refuelling and repair should be undertaken to ensure that these exercises are carried out on hardstands. This is to reduce the potential of soil contamination from spills. Spot checks should be conducted by NEPA. Person(s) appointed by the Project Manager may perform this exercise.
- Traffic should be monitored during construction to ensure approved traffic management plans at critical areas are being followed. NEPA and NWA should perform spot checks to ensure compliance. Monitoring should be conducted daily to ensure major disruption to the public transport is avoided.
- Where possible, construction crews should be sourced from within the study area. This will ensure that the local community will benefit from the investment. Person(s) appointed by the Project Manager may perform this exercise.

### 10.3 OPERATIONAL PHASE

- Water quality monitoring should be done at least monthly after construction. If three to six results demonstrate that the site or parts of the site have stabilised, the sampling frequency and sampling locations may be reviewed and reduced or discontinued as per approved monitoring plan.
- Water Quality Monitoring of wells by NEPA/WRA /NWC during operation.

### 10.4 REPORTING REQUIREMENTS

#### 10.4.1 Water Quality

A report shall be prepared by the Contacted party. It shall include the following data:

- i. Dates, times and places of test.
- ii. Weather condition.
- iii. A defined map of each location with distance clearly outlined in metric.
- iv. Test Method used.
- v. Parameters measured
- vi. Results
- vii. Conclusions

The report will be submitted to the Project Manager or his designate within two weeks of the monitoring being completed.

The Project Manager shall distribute the report within four (4) weeks of testing being completed to NEPA.

In the event that the water quality does not meet the required criteria, investigations shall be carried out and corrective actions were necessary taken and a re-test shall be scheduled at the earliest possible time and a new report submitted.

Reports will be maintained on file for a minimum of three years.

## 11.0 GLOSSARY OF TECHNICAL TERMS

### A

#### **ARCHAEOLOGICAL APPRAISAL**

It is an archaeological reconnaissance of an area or site to identify whether a development proposal has a potential archaeological dimension requiring further investigation.

#### **ARCHAEOLOGICAL IMPACT ASSESSMENT**

Archaeological Impact Assessment (AIA) is a systematic analysis of a project / development potential effect on all aspects of the material cultural heritage, in order to provide information for the deciding agency to consider in the decision-making process, and further give bodies with relevant environmental responsibilities the opportunity to comment before consent is given or denied.

#### **ARTEFACT**

An object produced or shaped by human craft especially a tool, weapon or ornament of archaeological or historical interest.

### B

#### **BENEFITS**

The asset value of a scheme, usually measured in terms of the cost of damages avoided by the scheme, or the valuation of perceived amenity or environmental improvements

#### **BIOLOGICAL OXYGEN DEMAND (BOD)**

The amount of oxygen taken up by aerobic microbes that decompose organic matter in a unit volume of water over a given time. It is used as a measure of the degree of organic pollution of water. The more organic matter the water contains, the more oxygen is used by microorganisms.

### C

#### **CALCAREOUS**

Containing calcium carbonate (CaCO<sub>3</sub>), chiefly as the minerals calcite and aragonite. When applied to rock, it implies that as much as 50 percent of the rock is carbonate (e.g., calcareous sand).

#### **CHART DATUM**

The plane or level to which soundings (or elevations) or tide heights are referenced (usually LOW WATER DATUM). The surface is called a tidal datum when referred to a certain phase of tide. To provide a safety factor for navigation, some level lower than MEAN SEA LEVEL is generally selected for hydrographic charts, such as MEAN LOW WATER or MEAN LOWER LOW WATER. See DATUM PLANE.

#### **CLAY**

A fine grained, plastic, sediment with a typical grain size less than 0.004 mm. Possesses electromagnetic properties which bind the grains together to give a bulk strength or cohesion. See SOIL CLASSIFICATION.

#### **CLIMATE**

The characteristic weather of a region, particularly regarding temperature and precipitation, averaged over some significant interval of time (years).

#### **CONTOUR**

A line on a map or chart representing points of equal elevation with relation to a DATUM. It is called an ISOBATH when connecting points of equal depth below a datum. Also called DEPTH CONTOUR.

#### **CYCLONE**

A system of winds that rotates about a centre of low atmospheric pressure. Rotation is clockwise in the Southern Hemisphere and anti-clockwise in the Northern Hemisphere. In the Indian Ocean, the term refers to the powerful storms called HURRICANES in the Atlantic.

## **D**

#### **DATUM**

Any permanent line, plane or surface used as a reference datum to which elevations are referred.

#### **DATUM, CHART**

See CHART DATUM.

#### **DECIBELS (DB)**

Is a dimensionless unit used to report sound pressure level (SPL or Lp). Decibels are used to represent the wide pressure range a human ear can detect. It is a logarithmic scale is used to report sound pressures.

#### **DEGRADATION**

The geologic process by means of which various parts of the surface of the earth are worn away and their general level lowered, by the action of wind and water.

#### **DENSITY**

Mass (in kg) per unit of volume of a substance; kg/m<sup>3</sup>. For pure water, the density is 1000 kg/m<sup>3</sup>, for seawater the density is usually more. Density increases with increasing salinity, and decreases with increasing temperature. More information can be found in "properties of seawater". For stone and sand, usually a density of 2600 kg/m<sup>3</sup> is assumed. Concrete is less dense, in the order of 2400 kg/m<sup>3</sup>. Some types of basalt may reach 2800 kg/m<sup>3</sup>. For sand, including the voids, one may use 1600 kg/m<sup>3</sup>, while mud often has a density of 1100 - 1200 kg/m<sup>3</sup>.



#### **DEPENDENCY RATIOS**

It is the portion of a population which is composed of dependents (people who are too young or too old to work). The dependency ratio is equal to the number of individuals aged below 15 or above 64 divided by the number of individuals aged 15 to 64, expressed as a percentage.

#### **DEPRESSION**

A general term signifying any depressed or lower area in the ocean floor.

#### **DEPTH**

The vertical distance from a specified datum to the sea floor.

#### **DESK-BASED ASSESSMENT**

This is an assessment of the known or potential archaeological resources within a specified area or site on land or underwater, consisting of a collection of existing written and graphic information in order to identify the likely character, extent, quality and worth of the known or potential archaeological resources in the local, regional, national or international context as appropriate.

#### **DISCHARGE**

The volume of water per unit of time flowing along a pipe or channel.

## **E**

#### **ECOSYSTEM**

The living organisms and the nonliving environment interacting in a given area, encompassing the relationships between biological, geochemical, and geophysical systems.

#### **ELEVATION**

The vertical distance from mean sea level or other established datum plane to a point on the earth's surface; height above sea level. Although sea floor elevation below msl should be marked as a negative value, many charts show positive numerals for water depth.

#### **EL NIÑO**

Warm equatorial water which flows southward along the coast of Peru and Ecuador during February and March of certain years. It is caused by poleward motions of air and unusual water temperature patterns in the Pacific Ocean, which cause coastal downwelling, leading to the reversal in the normal north-flowing cold coastal currents. During many El Niño years, storms, rainfall, and other meteorological phenomena in the Western Hemisphere are measurably different than during non-El Niño years.

#### **EROSION**

The wearing away of land by the action of natural forces.

#### **EVALUATION (HERITAGE)**

A limited programme of non-intrusive and/or intrusive fieldwork which determines the presence or absence of archaeological features, structures, deposits, artefacts or ecofacts within a specified area or site, and if present defines their character and extent, and relative quality. It enables an assessment of their worth in a local, national, regional or international context as appropriate.

## **F**

### **FAECAL COLIFORM**

A group of bacteria normally present in large numbers in the intestinal tracts of humans and other warm-blooded animals. Frequently used as an indicator of sewage pollution.

### **FAUNA**

The entire group of animals found in an area.

### **FLOOD**

(1) Period when tide level is rising; often taken to mean the flood current which occurs during this period (2) A flow beyond the carrying capacity of a channel.

### **FLORA**

The entire group of plants found in an area.

### **FLUVIAL**

Of or pertaining to rivers; produced by the action of a river or stream (e.g., fluvial sediment).

## **G**

### **GAUGE (GAGE)**

Instrument for measuring the water level relative to a datum or for measuring other parameters

### **GEOGRAPHICAL INFORMATION SYSTEM (GIS)**

Database of information which is geographically referenced, usually with an associated visualization system.

### **GEOMORPHOLOGY**

(1) That branch of physical geography which deals with the form of the Earth, the general configuration of its surface, the distribution of the land, water, etc. (2) The investigation of the history of geologic changes through the interpretation of topographic forms.

### **GEOTEXTILE**

A synthetic fabric which may be woven or non-woven used as a filter.

### **GDP**

Gross domestic product is the market value of all officially recognized final goods and services produced within a country in a given period of time (normally a year).

**GLOBAL POSITIONING SYSTEM (GPS)**

A navigational and positioning system developed by the U.S. Department of Defense, by which the location of a position on or above the Earth can be determined by a special receiver at that point interpreting signals received simultaneously from several of a constellation of special satellites.

**GRADIENT**

(1) A measure of slope (soil- or water-surface) in meters of rise or fall per meter of horizontal distance. (2) More general, a change of a value per unit of distance, e.g. the gradient in longshore transport causes erosion or accretion. (3) With reference to winds or currents, the rate of increase or decrease in speed, usually in the vertical; or the curve that represents this rate.

**GRADING**

Distribution, with regard to size or weight, of individual stones within a bulk volume; heavy, light and fine grading are distinguished.

**GRANULAR FILTER**

Band of granular material which is incorporated in an embankment, dam, dike, or bottom protection and is graded so as to allow seepage to flow across or down the filter zone without causing the migration of the material adjacent to the filter.

**GRAVEL**

Unconsolidated natural accumulation of rounded rock fragments coarser than sand but finer than pebbles (2-4 mm diameter).

## H

**HACH HYDROLAB DATASONDE-5**

A tethered device used to measure various water quality parameters.

**HERTZ (HZ)**

The time that it takes for a vibrating particle to complete one vibration is known as the time period. The number of vibrations (pressure variations) per second is called the frequency of the sound, and is measured in Hertz (Hz). The frequency of a sound produces its distinctive tone. Thus, the rumble of distant thunder has a low frequency, while a whistle has a high frequency.

**HURRICANE**

An intense tropical cyclone in which winds tend to spiral inward toward a core of low pressure, with maximum surface wind velocities that equal or exceed 33.5 m/sec (75 mph or 65 knots) for several minutes or longer at some points. TROPICAL STORM is the term applied if maximum winds are less

than 33.5 m/sec but greater than a whole gale (63 mph or 55 knots). Term is used in the Atlantic, Gulf of Mexico, and eastern Pacific.

#### **HURRICANE PATH OR TRACK**

Line of movement (propagation) of the eye through an area.

#### **HYDROGRAPHY**

(1) The description and study of seas, lakes, rivers and other waters. (2) The science of locating aids and dangers to navigation. (3) The description of physical properties of the waters of a region.

## **I**

#### **IN SITU**

In its original position or place, e.g. original deposition of artefact (heritage).

## **L**

#### **LANDMARK**

A conspicuous object, natural or artificial, located near or on land, which aids in fixing the position of an observer.

#### **LEQ**

The Leq represents the constant sound level in a specific situation and time period (e.g. 1hour (Leq (1)) or 24 hours (Leq (24)) conveys the same sound energy as time varying sound.

#### **LMIN**

The lowest instantaneous noise level during a specific period of time.

#### **LMAX**

It may also be referred to as the “peak (noise) level.” Lmax is the highest SPL measured over a time interval.

#### **L10**

The sound level exceeded 10 percent of the time. This is a measure of the louder sound levels during the measurement period. It tends to represent the sporadic or intermittent noise events (high fluctuations). For example, during a 1-hour measurement, a L10 of 84.6 dBA means the sound level was at or above 84.6 dBA for 6 minutes.

#### **L90**

The sound level exceeded 90 percent of the time. It is a measure of the nominal background level. It represents what is considered the ambient noise at a location. For example; during a 24-hour



measurement, a L90 of 84.6 dBA means the sound level was at or above 84.6 dBA for 21 hours and 36 minutes.

**LUGOL'S PRESERVE**

A solution of elemental iodine and potassium iodide in water.

## **M**

**MARKER, REFERENCE**

A mark of permanent character close to a survey station, to which it is related by an accurately measured distance and azimuth (or bearing).

**MORPHOLOGY**

River/estuary/lake/seabed form and its change with time.

**MOUTH**

Entrance to an inland water body (e.g., river).

**MUD**

A fluid-to-plastic mixture of finely divided particles of solid material and water.

## **N**

**NISKIN**

Device used to collect water samples at discrete depths in the water column.

**NOISE**

Noise is unwanted sound without agreeable musical quality. It is unwanted /undesired sound or sound in the wrong place at the wrong time. It is considered a pollutant and can be measured.

**NUMERICAL MODELING**

Refers to analysis of coastal processes using computational models.

## **O**

**OSCILLATION**

(1) A periodic motion backward and forward. (2) Vibration or variance above and below a mean value.

**OUTCROP**

A surface exposure of bare rock, not covered by soil or vegetation.

**OUTFALL**

A structure extending into a body of water for the purpose of discharging sewage, storm runoff, or cooling water.

## **P**

### **PEAK PERIOD**

The wave period determined by the inverse of the frequency at which the wave energy spectrum reaches its maximum.

### **PERCOLATION**

The process by which water flows through the interstices of a sediment. Specifically, in wave phenomena, the process by which wave action forces water through the interstices of the bottom sediment and which tends to reduce wave heights.

### **PEN**

Enclosure for animals, farm or gentleman's estate. Pens were types of estates which produced livestock and foodstuff for the local markets, but supplemented their income by the growing of pimento, cotton, logwood for export. Working cattle, horses, asses and mules were all raised for sale to estates and plantations where they were used to power mills and transport goods and people. Pens also purchased worn out cattle from estates and plantations and fattened them for the local market.

### **PHOTOSYNTHETICALLY ACTIVE RADIATION (PAR)**

The amount of light available for photosynthesis, which is light in the 400 to 700 nanometre wavelength range.

### **PHYTOPLANKTON**

Microscopic plant-like organisms that inhabit oceans and bodies of freshwater requiring sunlight in order to live and grow.

### **PM 10**

These are airborne particles that fall between 2.5 and 10 micrometres in diameter. They are considered coarse particles which are generated from sources such as crushing or grinding operations, and dust stirred up by vehicles traveling on roads.

### **PM 2.5**

These are airborne particles that have diameters below 2.5 micrometres. Sources of these fine particles include all types of combustion, including motor vehicles, power plants, residential wood burning, forest fires, agricultural burning, and some industrial processes.

### **POPULATION DENSITY**

The number of persons per square kilometre or acre of land area.

#### **PORE PRESSURE**

The interstitial pressure of water within a mass of soil or rock.

#### **POROSITY**

Percentage of the total volume of a soil sample not occupied by solid particles but by air and water,  $\eta$   
 $= V_v/V_T \times 100$

#### **PROBABILITY**

The chance that a prescribed event will occur, represented by a number (p) in the range 0 - 1. It can be estimated empirically from the relative frequency (i.e. the number of times the particular event occurs, divided by the total count of all events in the class considered).

## **R**

#### **RETURN PERIOD**

Average period of time between occurrences of a given event.

#### **RISK ANALYSIS**

Assessment of the total risk due to all possible environmental inputs and all possible mechanisms.

#### **RUINATE**

Area not presently in cultivation.

#### **ROCK WEATHERING**

Physical and mineralogical decay processes in rock brought about by exposure to climatic conditions either at the present time or in the geological past.

#### **ROCK**

(1) An aggregate of one or more minerals; or a body of undifferentiated mineral matter (e.g., obsidian). The three classes of rocks are: (a) Igneous – crystalline rocks formed from molten material. Examples are granite and basalt. (b) Sedimentary – resulting from the consolidation of loose sediment that has accumulated in layers. Examples are sandstone, shale and limestone. (c) Metamorphic – formed from pre-existing rock as a result of burial, heat, and pressure. (2) A rocky mass lying at or near the surface of the water or along a jagged coastline, especially where dangerous to shipping.

## **S**

#### **SEDIMENT**

(1) Loose, fragments of rocks, minerals or organic material which are transported from their source for varying distances and deposited by air, wind, ice and water. Other sediments are precipitated from the overlying water or form chemically, in place. Sediment includes all the unconsolidated materials on the sea floor. (2) The fine grained material deposited by water or wind.

**SLOPE**

The degree of inclination to the horizontal. Usually expressed as a ratio, such as 1:25, indicating one unit rise in 25 units of horizontal distance; or in a decimal fraction (0.04). Also called GRADIENT.

**SLUMP**

In mass wasting, movement along a curved surface in which the upper part moves vertically downward while the lower part moves outward.

**SOCIAL IMPACT AREA (SIA)**

Estimated spatial extent of the proposed project's effect on surrounding communities, demarcated as a buffer of specified distance, e.g. 2 km from the proposed project.

**SOIL**

A layer of weathered, unconsolidated material on top of bed rock; in geologic usage, usually defined as containing organic matter and being capable of supporting plant growth.

**SOIL CLASSIFICATION (SIZE)**

An arbitrary division of a continuous scale of grain sizes such that each scale unit or grade may serve as a convenient class interval for conducting the analysis or for expressing the results of an analysis. There are many classifications used.

**SORTING**

Process of selection and separation of sediment grains according to their grain size (or grain shape or specific gravity).

**SOUND**

(1) (noun) a relatively long arm of the sea or ocean forming a channel between an island and a mainland or connecting two larger bodies, as a sea and the ocean, or two parts of the same body; usually wider and more extensive than a STRAIT (e.g., Long Island Sound). (2) (verb) To measure the depth of the water.

**SPECIFIC GRAVITY**

The ratio of the weight of unit volume of any material to the weight of unit volume of water at 4 deg C,  $G_s = \gamma_s/\gamma_w$ . Typical values of  $G_s$  for soil solids are 2.65 to 2.72.

**SPL (SOUND PRESSURE LEVEL)**

A ratio of one sound pressure to a reference pressure.

$SPL = 20 \log (L/L_r) \text{ dB}$  where  $L_r$  is the reference pressure

**STONE**

Quarried or artificially-broken rock for use in construction, either as aggregate or cut into shaped blocks as dimension stone.



**SURVEY, CONTROL**

A survey that provides coordinates (horizontal or vertical) of points to which supplementary surveys are adjusted.

**SURVEY, TOPOGRAPHIC**

A survey which has, for its major purpose, the determination of the configuration (relief) of the surface of the land and the location of natural and artificial objects thereon.

**SUSPENDED LOAD**

(1) The material moving in suspension in a fluid, kept up by the upward components of the turbulent currents or by colloidal suspension. (2) The material collected in or computed from samples collected with a SUSPENDED LOAD SAMPLER. Where it is necessary to distinguish between the two meanings given above, the first one may be called the "true

**SUSPENDED LOAD SAMPLER**

A sampler which attempts to secure a sample of the water with its sediment load without separating the sediment from the water.

## T

**TAÍNO**

Amerindian people inhabiting Jamaica from around AD 650 into the seventeenth century. It is estimated that some 50- 60,000 Taíno lived in Jamaica at the arrival of the Spaniards

**TOPOGRAPHIC MAP**

A map on which elevations are shown by means of contour lines.

**TOPOGRAPHY**

The configuration of a surface, including its relief and the positions of its streams, roads, building, etc.

**TOTAL DISSOLVED SOLIDS (TDS)**

Compounds in the water that cannot be removed by a traditional filter and are made up of salts or compounds which dissociate in water to form ions.

**TOTAL PETROLEUM HYDROCARBON (TPH)**

A mixture of chemicals made mainly from hydrogen and carbon.

**TOTAL SUSPENDED SOLIDS (TSS)**

Solid materials, including organic and inorganic, that are suspended in the water.

**TROPICAL CYCLONE**

See HURRICANE

**TROPICAL STORM**

A tropical cyclone with maximum winds less than 34 m/sec (75 mile per hour). Compare with HURRICANE (winds greater than 34 m/sec).

#### **TSUNAMI**

A long-period water wave caused by an underwater disturbance such as a volcanic eruption or earthquake. Also SEISMIC SEA WAVE. Commonly miscalled "tidal wave."

#### **TURBIDITY**

(1) A condition of a liquid due to fine visible material in suspension, which may not be of sufficient size to be seen as individual particles by the naked eye but which prevents the passage of light through the liquid. (2) A measure of fine suspended matter in liquids.

#### **TURBULENT FLOW**

Any flow which is not LAMINAR, i.e., the stream lines of the fluid, instead of remaining parallel, become confused and intermingled.

## **U**

#### **UPLAND**

Dry land area above and landward of the ORDINARY HIGH WATER MARK (OHWM). Often used as a general term to mean high land far from the COAST and in the interior of the country.

#### **UPLIFT**

The upward water pressure on the base of a structure or pavement.

#### **UPSTREAM**

Along coasts with obliquely approaching waves there is a longshore (wave-driven) current. For this current one can define an upstream and a DOWNSTREAM direction. For example, on a beach with an orientation west-east with the sea to the north, the waves come from NW. Then the current flows from West to East. Here, upstream is West of the observer, and East is DOWNSTREAM of the observer.

## **V**

#### **VISCOSITY (OR INTERNAL FRICTION)**

That molecular property of a fluid that enables it to support tangential stresses for a finite time and thus to resist deformation. Resistance to flow.

## **W**

#### **WETLAND**

Lands whose saturation with water is the dominant factor determining the nature of soil development and the types of plant and animal communities that live in the soil and on its surface (e.g. Mangrove forests).

**WELL-SORTED**

Clastic sediment or rock that consists of particles all having approximately the same size. Example: sand dunes.

## 12.0 REFERENCES

- Adams. C.D. 1972. Flowering Plants of Jamaica. University of the West Indies Press, Mona Jamaica
- Ayyappan, N., and N. Parthasarathy. 2001. "Composition, Population Structure and Distribution of Dipterocarps in a Tropical Evergreen Forest at Varagalaiar, Anamalais, Western Ghats, South India." *Journal of Tropical Forest Science* no. 13 (2):311-321.
- Barbour, M.G., J.H. Burk, and W.D. Pitts. 1987. "Method of Sampling the Plant Community." In *Terrestrial Plant Ecology*, 210 - 239. Menlo Park, California: Benjamin/Cummings Publishing Co.
- Bibby C.J.; Jones, M.J. and S.J. Marsden. 1998. *Expedition Field Techniques: Bird Surveys*. Expedition Advisory Centre, Royal Geographical Society, London.
- Brown, M. and B Heineman. 1972. Jamaica and its Butterflies. E.W. Classey, London.
- Campbell, Keron C. St. E., *Endemic Trees of Jamaica* (Kingston: Institute of Jamaica Publications), 2010
- Craskell, Thomas and James Simpson *Map of the Island of Jamaica* (surveyed 1756-61), (1763)
- Devi, L. Supriya, and P. S. Yadava. 2006. "Floristic diversity assessment and vegetation analysis of tropical semi-evergreen forest of Manipur, north east India." *Tropical Ecology* no. 47 (1):89-98.
- Duerden, J. E. " Aboriginal Indian Remains in Jamaica" in *Journal of the Institute of Jamaica* Volume II, No. 4, July, 1897
- Estate maps of St. Catherine-St. C 389
- Feurtado, W.A *Official and other Personages of Jamaica from 1655 to 1790* (Kingston, Jamaica), 1896
- Foggi, Bruno. *Flowers of the Caribbean*\_(Casa Editrice: Italy), 2007
- Garraway, E. and A.J.A. Bailey. 2005. Butterflies of Jamaica. Macmillan Caribbean.
- GOJ. Development and Investment Manual, Vol.1, Section 1, 2007
- Hand Book of Jamaica 1918, 1920, 1944-1945
- Hargreaves, Dorothy and Bob *Tropical Trees* (Hargreaves Industrial: Portland, Oregon), 1965
- Harrison, Thomas, *Map of St Catherine 1882-83*
- Higman, B. *Jamaica Surveyed* (Kingston: Institute of Jamaica Publications), 1988



Humpherys, Marjorie. *Cerisee and other Jamaican Flowering Plants*\_(The Mills Press Kingston: Jamaica), 1999

International Best Track Archive for Climate Stewardship (IBTrACS), 2012. IBTrACS v03r05.

International Union for Conservation of Nature. The IUCN Red List of Threatened Species. Date accessed: 26/06/2014. <http://www.iucnredlist.org/amazing-species>

Jamaica 1:50,000, (Series E721) Sheet G First Edition, DSO 410, 1958

Jamaica 1:50,000 (Metric Edition) Series 1 Sheet 12 Edition 1-JSD/OSD 1987

Lévesque, Mathieu, Kurt P. McLaren, and Morag A. McDonald. 2011a. "Coppice shoot dynamics in a tropical dry forest after human disturbance." *Journal of Tropical Ecology* no. 27 (03):259-268. doi: doi:10.1017/S0266467410000805.

Lévesque, Mathieu, Kurt P. McLaren, and Morag A. McDonald. 2011b. "Recovery and dynamics of a primary tropical dry forest in Jamaica, 10 years after human disturbance." *Forest Ecology and Management* no. 262 (5):817-826. doi: <http://dx.doi.org/10.1016/j.foreco.2011.05.015>.

List of Properties 1912, 1920, 1930

McLaren, Kurt P., and Morag A. McDonald. 2003. "Seedling dynamics after different intensities of human disturbance in a tropical dry limestone forest in Jamaica." *Journal of Tropical Ecology* no. 19 (05):567-578. doi: doi:10.1017/S0266467403003626.

Mines and Geology Division. 1: 50,0000 Geological Series (Metric Edition), Geological Sheet 12 and 17,

Mines and Geology Division. 2011. Hillside Development Manual for Jamaica.

Mitchell, S and M.H. Ahmad "Protecting our Medicinal Plant Heritage: The Making Of A New National Treasure" in *Jamaica Journal* Vol. 29 No.3, December 2005-April 2006

Parker, Tracey 2003. Manual of Dendrology – Jamaica. Forestry Department, Ministry of Agriculture, Government of Jamaica.

Return of Properties 1882

Raffaele, Herbert; Wiley, James; Garrido, Orlando; Keith, Allan and J. Raffaele 1998. A Guide to the Birds of the West Indies. Princeton University Press

Robertson, Diane *Jamaican Herbs: Nutritional & Medicinal Values* (Jamaica), 1988

Robertson, James *To his Royal Highness the Duke of York this map of the County of Cornwall & Middlesex in the Island of Jamaica..* London: Published (Nov. 1st, 1804)

Saunders, Mark A., and Adam S. Lea, 2008. "Large Contribution of Sea Surface Warming to Recent Increase in Atlantic Hurricane Activity." *Nature* 451 (January 31, 2008):557–560.

Sibley, Inez Knibb) *Dictionary of Place Names in Jamaica* (Kingston: Institute of Jamaica Publications) 1978

Storer, Dorothy P *Familiar Trees And Cultivated Plants Of Jamaica* (Kingston: Institute of Jamaica Publications), 1958.

The Jamaica Almanac 1810-1845

Tripplehorn, C.A. and N.F. Johnson. 2005. Borrow and Delong's introduction to the study of insects.

World Health Organization (WHO) Regional Office. 1998. *The Impact of Cemeteries on the Environment and Public Health – An Introductory Briefing.*

Wright, Phillip *Monumental Inscriptions of Jamaica* (London: Society of Genealogists), 1966

Wunderle Jr, J.M. 1994. *Census methods for Caribbean land birds.* Gen. Tech. Rep. SO-98. New Orleans, LA: U.S. Department of Agriculture, Forest Service, Southern Forest Experiment Station.

## 13.0 APPENDICES

## Appendix 1 – Terms of Reference

# **TERMS OF REFERENCE for an ENVIRONMENTAL IMPACT ASSESSMENT**

**FOR A  
PROPOSED CEMETERY DEVELOPMENT**

**AT  
Part of Chisholm called Bendon Pen, St. Johns Road,  
St Catherine, JAMAICA**

**By  
KUMANDA PARK LIMITED**

**06 DECEMBER 2013**

**Submitted by:**  
**Prepared by: <Include Name of Consultant>**

**Date**

---

NATIONAL ENVIRONMENT & PLANNING AGENCY  
Terms of Reference for Environmental Impact Assessment  
Proposed Cemetery Development at Dovecot, St Catherine, Jamaica  
First Draft: 05 December 2013

1



## TABLE OF CONTENTS

1. Background .....	3
1. Executive Summary .....	4
2. Introduction .....	4
3. Legislation and Regulatory Consideration .....	4
4. Project Description.....	4
5. Description of the Environment.....	5
5.1 Physical Environment .....	5
5.2 Carrying Capacity .....	6
5.3 Natural Hazards .....	6
5.4 Biological Environment .....	6
5.5 Heritage .....	6
5.6 Socio-economic Environment.....	7
6. Public Participation.....	7
7. Impact Identification .....	7
7.1 Physical.....	8
7.2 Natural Hazards and Flooding Potential.....	8
7.3 Biological .....	8
7.4 Heritage .....	8
7.5 Human/Social/Cultural .....	8
7.6 Public Health Issues of Concern .....	9
7.7 Risk Assessment.....	9
8. Impact Mitigation .....	9
9. Residual Impacts.....	9
10. Analysis of Alternatives.....	9
11. Environmental Monitoring and Management .....	9
12. List of References .....	10
13. Appendices.....	10
13.1 Reference documents.....	10
13.2 Photographs/ maps .....	10
13.3 Data Tables.....	10
13.4 Glossary of Technical Terms used.....	10
13.5 Terms of Reference.....	10
13.6 Composition of the consulting team that undertook the study/assessment including name, qualification and roles of team members .....	10
13.7 Notes of Public Consultation sessions.....	10
13.8 Instruments used in community surveys.....	10
14. ACTIVITIES.....	10
14.1 Documentation Review .....	10
14.2 Analysis of Alternatives.....	11
14.3 Impact Assessment .....	11
15. Outline of a Typical EIA Report.....	12

### 1. Background

Kumanda Park Limited has expressed a desire to establish a cemetery development at Part of Chisholm called Bendon Pen, St. Johns Road, St Catherine.

Further to a field inspection conducted in November 2013 by the National Environment and Planning Agency (NEPA) it was determined that given the nature and scope of the proposed development, the existing vegetation cover, the expected loss of biodiversity and the potential negative environmental impacts an Environmental Impact Assessment (EIA) will be required to support any decision regarding the proposed development.

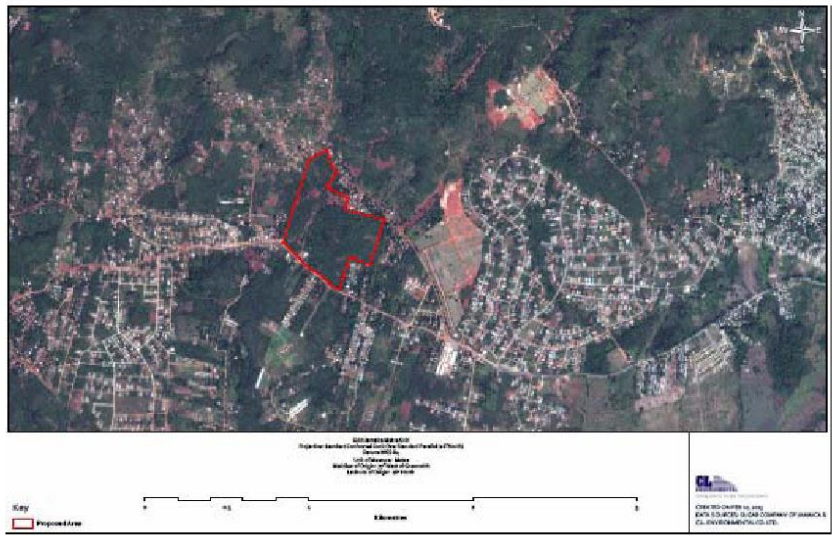

The purpose of this document is therefore to establish the Terms of Reference (TOR) for the EIA.

The EIA report must be produced in accordance with this TOR.

Where the need arises to modify the TOR, the required amendments/modifications are to be made and submitted to the Agency. Approval for the TOR must be obtained from the Agency, in writing, prior to the commencement of the EIA study.

**The Terms of Reference to conduct the Environmental Impact Assessment are as follows:**

### **1. Executive Summary**

Provide a brief statement on the content of the EIA report. Include relevant background information, the main findings, analyses and conclusions in the report.

### **2. Introduction**

Provide the context of the project and the EIA, the delineation and justification of the boundary of the study area, general methodology, assumptions and constraints of the study.

The study area shall include at least the area within 1km radius of the boundaries of the proposed site.

### **3. Legislation and Regulatory Consideration**

Outline the pertinent regulations, standards, government policies and legislation governing environmental quality, safety and health, protection of sensitive areas, protection of endangered species, siting and land use control at the national and local levels. The examination of the legislation should include at minimum, legislation such as the Natural Resources Conservation Authority Act, the Housing Act, the Town and Country Planning Act, Building Act and Codes and Standards promulgated there under, Development Orders and Plans and all appropriate international convention/protocol/treaty where applicable. Describe traditional land use and advise of any prescriptive rights including public access rights.

### **4. Project Description**

Prepare a detailed description of the project. This section will provide information on the proposed project and should include:

- History and background of the project,
- A location map at a scale of 1:12,500 (or an appropriate scale)
- The total area of the site. That is, the respective areas (in square metres) of the existing cemetery and areas of the site earmarked for the proposed expansion.
- A site layout plan showing the various components and design elements of the proposed development.
- A comprehensive description of all components e.g. chapel and crematorium and the various design elements of the project.
- The spatial allotments for the various design elements of the project, such as the quantum of land to be reserved for buildings, roads, burial and landscaping and the number of parking bays.
- The total number and types (single/double) of vaults proposed.
- The burial density; i.e. the number of vaults per hectare/square metres
- The typical design proposed for the vaults
- Expected project components and alternatives that may be considered by the developer,

- Schematic plans,
- A detailed landscape plan highlighting grading and proposed changes in topography.
- Details of proposed access(es) to the site to be used for pre-construction, construction and operational phases
- Details on infrastructure development including design plans for all components of the development including the proposed wastewater/sewage treatment system and disposal of treated effluent must be clearly outlined.
- A comprehensive drainage assessment. This assessment should take into consideration existing natural drainage channels, proposed man-made drainage/water features or any proposed changes in topography. Potential issues of increased surface runoff and sediment loading must also be addressed. Special emphasis should also be placed on the storm water run-off, drainage patterns, characteristics of the aquifer, including the level and status of the groundwater.
- In addition plans for providing utilities, particularly details relating to the source of potable water and electricity generation, roads and other services should be clearly stated.
- A Waste Management Plan which clearly outlines expected quantities of construction waste during the construction phase, general waste arising from material consumption of the workforce, as well as, all expected waste during the operational phase should be completed. Details should also be provided for any central disposal area(s) being considered to serve the proposed development
- Details of equipment and machinery to be involved, how these will be mobilized and areas to be used for storage of machinery and material should be clearly indicated.
- Details of workforce, including proposals for mobilization and accommodation should be indicated.
- All phases of the project should be clearly defined, the relevant time schedules provided and phased maps, diagrams and appropriate visual aids included in the Environmental Impact Assessment report.
- The study area should be clearly delineated and referenced. Taking into account the types of resources located in the area and the magnitude of the associated impacts, the study area should be large enough to include all valued resources that might be significantly affected by the project.

## 5. Description of the Environment

A natural resources survey of the proposed development site should be conducted for both the wet and dry seasons. This information will form the basis upon which impacts of the project will be assessed.

The following aspects should be described in this section:

### 5.1 Physical Environment

- Topography, soils, climate, drainage, geology (including but not limited to seismicity and faults), geomorphology of the site and hazard vulnerability including impacts on current landscape, aesthetic appeal and hydrology should be examined. Special

emphasis should be placed on storm water runoff, drainage patterns. Percolation tests should also be conducted within the proposed study area.

- **Water quality** for any riverine environment or surface water feature in the vicinity of the development. Quality Indicators should include but not be limited to Nitrate, Phosphate, Faecal Coliform, and Total Suspended Solids.
- **Climatic conditions and air quality** in the area of influence including particulates
- Noise levels of undeveloped site and the ambient noise in the area of influence.
- Sources of pollution existing and extent of contamination.
- Availability of solid waste management facilities.

## 5.2 *Carrying capacity*

- The ecological carrying capacity of the site should be assessed

## 5.3 *Natural Hazards*

- Hurricanes, Earthquakes
- Natural hazard risk assessment should take in account climate change projections.

## 5.4 *Biological Environment*

Description of terrestrial habitats, existing vegetation, flora and fauna surveys inclusive of a species list; commentary on the ecological health, function and value in the project area, threats and conservation significance.

This should include:

- A detailed qualitative and quantitative assessment of terrestrial habitats in and around the proposed project sites and the areas of impact. This must also include flora and fauna surveys and should include species lists.
- Special emphasis should be placed on rare, endemic, protected or endangered species. Migratory species should also be considered. There may be the need to incorporate micro-organisms to obtain an accurate baseline assessment. Generally, species dependence, habitats/niche specificity, community structure and diversity ought to be considered.

The field data collected should include, but not be limited to:

- Vegetation profile
- Other benthic features of the proposed development areas as well as the areas of potential impact
- Species lists must be provided for each community
- A habitat map of the area

## 5.5 *Heritage*

- Archaeological and cultural assessments



### **5.6 Socio-economic Environment**

Demography, regional setting, location assessment and current and potential land-use patterns (of neighbouring properties); description of existing infrastructure such as transportation, electricity, water and telecommunications, and public health safety; cultural peculiarities, aspirations and attitudes should be explored; and other material assets of the area should also be examined. A socio-economic survey to determine public perception of the project should also be complete and this should include but not be limited to potential impacts on social, aesthetic and historical/ cultural values.

### **6. Public Participation**

Describe the public participation methods, timing, type of information provided and collected from public and stakeholder target groups meetings. The instrument used to collect the information must be included in the appendix. Stakeholder meetings should also be held to inform the public of the proposed development and the possible impacts, and will also gauge the feeling/response of the public toward the development.

The issues identified during the public participation process should be summarized and public input that has been incorporated or addressed in the EIA should be outlined.

Public Meetings should be held in accordance with the Guidelines for Conducting Public Presentation at a time and location signed off by the National Environment and Planning Agency (NEPA). A public meeting will be held to present the findings of the EIA once the EIA is completed and submitted for consideration. All relevant documents are required to be made available to the public. In addition, any material change to the design of the project will require a further public meeting to be undertaken by the developer and all changes made to the document, should be clearly outlined to the public.

### **7. Impact Identification**

A detailed analysis of the project components should be done in order to: identify the major potential environmental and public health impacts of the project; distinguish between significant positive and negative impacts, reversible or irreversible direct and indirect, long term and immediate impacts and identify avoidable as well as irreversible impacts.

Cumulative impacts should also be evaluated taking into account previous developments and any proposed development immediately adjacent to the subject development within the Dovecot Area. The identified impacts should be profiled to assess the magnitude of the impacts. The extent and quality of the available data should be characterized, explaining significant information deficiencies and any uncertainties associated with the predictions of impacts. A major environmental issue is determined after examining the impact (positive and negative) on the environment and having the negative impact significantly outweigh the positive. It is also determined by the number and magnitude of mitigation strategies which need to be employed to reduce the risk(s) introduced to the environment. Project activities and impacts should then be ranked as major, moderate and minor and presented in separate matrices for all the phases of the project (i.e. preconstruction, construction and occupation and operational).

The impacts to be assessed will include but not be limited to the following:

### **7.1 Physical**

- Impacts of construction activities such as site clearance, earthworks and spoil disposal.
- Impacts of accidental oil and chemical spills
- Impacts on Air Quality
- Impacts on Water Quality (pollution of potable, coastal, surface and ground water
- Demands/requirements of the following must be quantified
  - Water Supply
  - Drainage
  - Sewage Disposal - Empirical data must be provided to show that the sewage treatment facility has the capacity to remove the nutrients to meet the National Sewage Effluent Standards;
  - Wastewater Disposal
  - Trade Effluent Discharges
  - Solid Waste Disposal
  - Electrical Power(fossil fuels, wind, sun, wave and tidal)
  - Communications and other utility requirements
  - Transport Systems and supporting infrastructure required
- Operation and maintenance – waste disposal, site drainage, sewage treatment and disposal solution, and air quality;
- Impacts on visual aesthetics and landscape
- Noise
- Change in drainage pattern
- Carrying capacity of the proposed site

### **7.2 Natural Hazard**

Impact of Natural Hazards: (such as Hurricanes and Earthquakes) and flooding potential

### **7.3 Biological**

Direct and indirect impact on ecology and on the terrestrial and marine habitats. Emphasis should be placed on any rare, endangered, and endemic species found. This should include habitat loss and fragmentation, loss of species and natural features due to construction and operation. Impact of noise and vibration especially on marine mammals and sea turtles should be examined as well as the impact of light pollution.

### **7.4 Heritage**

Loss of and damage to: artifacts, archaeological, geological and paleontological features

### **7.5 Human/Social/Cultural**

Effects on socio-economic status such as changes to public access & recreational use, impacts on existing and potential economic activities, public perception, contribution of development to

NATIONAL ENVIRONMENT & PLANNING AGENCY

Terms of Reference for Environmental Impact Assessment

Proposed Cemetery Development at Dovecot, St Catherine, Jamaica

First Draft: 05 December 2013

8

national economy and development of surrounding communities. Socio-economic and cultural impacts to include land use/resource effects.

#### **7.6 Public Health Issues of Concern**

#### **7.7 Risk Assessment**

Analyze the risks to human health and ecosystems associated with the development from both human activities and natural phenomenon. This should include: 1) Identifying the hazards 2) Assessing the potential consequences 3) Assessing the probability of the consequences and 4) Characterizing the risk and uncertainty. The monetary costs of the risks, the costs of emergency response and/or avoidance of risks should also be considered.

### **8 Impact Mitigation**

Mitigation and abatement measures should be developed for each potential negative impact identified. This should include recommendations for the enhancement of beneficial impacts and quantify and assign financial and economic values to mitigating methods. Green building technology should be examined. A statement is to be made on strategies that will be used to conserve energy and water in relation to this development.

### **9 Residual Impacts**

Identify any residual negative impacts that potentially have no solution for mitigation.

### **10 Analysis of Alternatives**

This should include the no action alternative and project design alternatives. These should be assessed according to the physical, ecological and socio-economic parameters of the site. The examination of project alternatives should incorporate the use history of the overall area in which the site is located and previous uses of the site itself. A rationale for the selection of any project alternative should be provided.

### **11 Environmental Monitoring and Management**

An environmental monitoring and management plan should be developed which will detail the requirements for construction and operational phases of the project. This should include, but not be limited to training for construction and operation staff, as well as include recommendations to ensure the implementation of mitigation measures and long term minimization of negative impacts

A draft environmental monitoring programme should be included in the EIA, and a detailed version submitted to NEPA for approval after the granting of the permit and prior to the commencement of the development. At the minimum the monitoring programme and report should include:

- Introduction outlining the need for a monitoring programme and the relevant specific provisions of the permit license(s) granted.

- The activity being monitored and the parameters chosen to effectively carry out the exercise.
- The methodology to be employed and the frequency of monitoring.
- The sites being monitored. These may in instances, be pre-determined by the local authority and should incorporate a control site where no impact from the development is expected.
- Frequency of reporting to NEPA

The Monitoring report should also include, at minimum:

- Raw data collected. Tables and graphs are to be used where appropriate
- Discussion of results with respect to the development in progress, highlighting any parameter(s) which exceeds the expected standard(s).
- Recommendations
- Appendices of data and photographs if necessary.

## 12 List of References

## 13 Appendices

The appendices should include but not be limited to the following documents:

- 13.1 Reference documents
- 13.2 Photographs/ maps
- 13.3 Data Tables
- 13.4 Glossary of Technical Terms used
- 13.5 Terms of Reference
- 13.6 Composition of the consulting team, team that undertook the study/assessment, including name, qualification and roles of team members
- 13.7 Notes of Public Consultation sessions
- 13.8 Instruments used in community surveys

## 14 ACTIVITIES

In order to effectively and efficiently conduct the Environmental Impact Assessment it will be necessary to carry out various activities which include:

### 14.1 Documentation Review

All documentation pertaining to the development will need to be reviewed. These should include, but not limited to, the project profile, site plan, drainage plan, vegetation clearance plan, applications

made for financing or planning approval, and any technical and engineering studies that have been done.

#### **14.2 Analysis of Alternatives**

Alternatives to the site location, project design and operation conditions will be analyzed including the “no-action” alternative. These alternatives will be assessed based on the physical, ecological and socio-economic parameters of the site identified. The consultant should provide justification for the selection of the chosen alternative(s). The physical, biological and sociological settings will provide the framework in which to assess the different project alternatives.

#### **14.3 Impact Assessment**

The consultant should carry out a detailed impact assessment of the project components (pre-construction, construction and operation stages) in order to identify the potential impacts (positive, negative and cumulative impacts) that will be associated with the project. The significance and magnitude (major, moderate and minor) of the impacts identified will also be evaluated through the use of a weighted matrix.

The impacts to be assessed will include but not limited to the following:

- Effects of project design and engineering;
- Effects on visual aesthetics and landscape;
- Effect of noise and vibration;
- Effects of construction activities such as site clearance and geological formation, earthworks, hurricanes, access routes, transportation networks and spoil disposal;
- Effects of operation and maintenance activities such as waste disposal, traffic management, site drainage, sediment, sewage, public access and air quality; and
- Effects on ecology including effect on terrestrial and marine habitats  
Emphasis should be placed on any rare, endangered, and endemic species found  
Effects on socio-economic status such as changes to public access, recreational use, existing and potential agricultural activities, contribution of development to national economy and development of surrounding communities.

The physical, biological and sociological status will provide the framework in which to assess the impacts of the proposed project.

All findings must be presented in the EIA report and must reflect the headings in the body of the TORs, as well as references. Fifteen hard copies and an electronic copy of the report should be submitted. One copy of the document should be perfect bound.

The report should include an appendix with items such as maps, site plans, the study team, photographs, and other relevant information.

See outline below:-



## 15 Outline of a Typical EIA Report

The report should contain an introduction explaining the need for, and context of the project. This document should have the following basic aspects included in the Table of Contents, unless specified otherwise in the Terms of Reference.

- Executive Summary
- Policy, Legal and Administrative Framework
- Description of the Existing Environment
- Description of the Proposed Project in detail
- Identification and Assessment of Potential Environmental Impacts
  - Physical
  - Natural Hazard Risk
  - Biological
  - Human/Social
- Cumulative Impacts
- Positive Impacts
- Public Involvement
- Recommended Mitigation Measures
- Identification and Analysis of Alternatives
- Environmental Management of the Project
- Environmental Quality Objectives
- Training
- Draft Outline Monitoring Programme
- List of References
- Appendices including:
  - Reference documents
  - Photographs/ maps
  - Data Tables
  - Terms of Reference
  - Composition of the consulting team
  - Notes of Public Consultation sessions

## Appendix 2 – Study Team

### CL Environmental Co. Ltd.

- Carlton Campbell, Ph.D. pending CIEC (Noise, Socioeconomics)
- Matthew Lee, M.Sc. (Noise, Particulates, Water Quality)
- Kristoffer Lue, M.Phil. (Water Quality)
- Rachel D'Silva, M.Sc. pending (Water Quality)
- Karen McIntyre, M.Sc. pending (GIS, Legislation, Human/Social Environment)
- Glen Patrick, Field Technician (Noise and Particulates)
- Errol Harrison, Field Technician (Noise and Particulates)

### Associates/ Consultants

- CEAC Solutions Ltd. (Project Description, Hydrology and Hydrogeology):
  - Christopher Burgess, M.Sc. Eng., PE (Lead Engineer – Hydrology and Hydrogeology)
  - Carlenus Johnson, B. Eng. (Hydrology)
  - Kristoffer Freeman, B. Sc. (Hydrogeology)
  - Marc Henry, GIS Technician
- Environmental Management Consultants Caribbean Ltd. (Geology and Hazards)
  - Ravidya Burrowes, Ph. D (Geology and Hazards)
  - Marc Rammelare, M. Sc (Geology and Hazards)
- Jamaica Environmental and Management Services Ltd. (Socioeconomic Survey)
  - Janette Manning, M. Phil
- Jamaica National Heritage Trust:
  - Selvenious Walters (Deputy Technical Director of Archaeology)
  - Audene Brooks (Senior Archaeologist)
  - Rose Marie Whittaker (Senior Archaeologist)
  - Ann-Marie Howard- Brown (Curator)
  - Edward Coore (Artist /Illustrator/ Surveyor)
  - Ricardo Tyndall (Archaeological Field Assistant)
  - Ryan Murphy (Archaeological Field Assistant)
  - Clifton McKen (Archaeological Field Assistant)
  - Clive Brooks (Driver)
  - Andrew Pearson (Supervisor- Dove Cot Memorial Park)
  - Fitzroy Howell (Informant Bendon Pen)
  - Mrs. Francis (Informant Bendon Pen)
  
- Dr. Eric Garraway, Ph. D (Faunal Studies)
- Swayne Beckles, M. Phil (Vegetation Survey)

## Appendix 3 – NEPA Guidelines for Public Participation

**NATIONAL ENVIRONMENT AND PLANNING AGENCY**

**NATURAL RESOURCES CONSERVATION  
AUTHORITY**

# **GUIDELINES FOR CONDUCTING PUBLIC PRESENTATIONS**

**2007-10-25**

## SECTION 1: GENERAL GUIDELINES

### 1.1 Introduction

There are usually two forms of public involvement in the Environmental Impact Assessment (EIA) process. The first is direct involvement of the affected public or community in public consultations during the EIA study. These consultations allow the developer to provide information to the public about the project and to determine what issues the public wishes to see addressed. The extent and results of these consultations are included in the documented EIA report.

The second level of involvement takes place after the EIA report and addendum, if any, have been prepared after the applicant has provided the information needed for adequate review by NEPA and the public.

Public involvement in the review process is in keeping with Principle 7 of the United Nations Environment Programme (UNEP) decision published as Goals and Principles of Environmental Impact Assessment [Decision 14/25 of the Governing Council of UNEP, of 17, June, 1987]

### 1.2 Purpose

These guidelines are prepared for the use of the developer/project proponent; the consultants involve in conducting the EIA study and prepared the EIA report and the public.

## **SECTION 2: SPECIFIC GUIDELINES FOR PUBLIC PRESENTATIONS**

### **2.1 Requirements**

Arrangements for the public presentation must be made in consultation with NEPA in respect of date, time, venue, chairperson and participants.

A permanent record of the meeting is required hence, the project proponent/consultant will submit to NEPA a copy of the verbatim report of the public presentation within seven (7) days of the date of the meeting.

### **2.2 Public Notification**

The public must be notified at least three weeks before the date of the public presentation. The developer/consultants must seek to ensure that in addition to specific invitation letters, at least three (3) notices are placed in the most widely circulated newspapers advertising the event. The notice shall also be forwarded to NEPA for posting on the website. To ensure that the notice is distributed as widely as possible, other methods of notification such as community notice board, flyers, town criers etc. shall be utilized as appropriate. In addition, specific notice to relevant local NGOs and community groups should be made by the developer/consultants.

The notice should indicate that:-

- the EIA has been submitted to NEPA;
  - the purpose of the meeting;
  - how to access the EIA report for review
- the date, time and venue of the public presentation.

The public presentation should be conducted no less than 3 weeks after the EIA has been made available to the public and no less than 3 weeks after the first notice announcing public presentation has been published by the applicant.

***(A typical notice is in Appendix 1).***



### 2.3 Responsibility of Developer/Consultant Team

The developer/consultant is responsible for distribution of copies of the EIA Report to make them available to the public at least three weeks before the public presentation.

Copies should be placed in the Local Parish Library and the Parish Council Office as well as at the nearest NEPA Regional Office and other community locations as agreed upon.

A summary of the project components and the findings of the EIA in non-technical language should also be prepared for distribution at the public presentation.

### 2.4 Conduct of the Meeting

With respect to the conduct of the meeting, the chairperson should be independently selected so as to ensure his/her neutrality. NEPA should be consulted regarding the selection of a chairperson. The role and responsibilities of the chairperson are outlined **Appendix 3**.

The technical presentation by the project proponent/consultant should be simple, concise and comprehensive. The main findings of the EIA including adverse and beneficial impacts identified and analyzed should be presented.

Mitigation measures and costs associated with these measures should be presented. The presentation should inform the public on how they will get access to monitoring results during the construction and operational phases of the project, bearing in mind that the public and non-governmental groups are expected to be involved in post-approval monitoring. Graphic and pictorial documentation should support the technical presentation.

Presenters are advised to keep the technical presentation simple and within a time limit of 20-30 minutes depending on the complexity of the project and to allow a minimum of 30 minutes for questions.

The project proponent/consultant will submit to NEPA a copy of the verbatim report of the public presentation within seven (7) days of the date of the meeting.

Please note that the public will be given a period of thirty (30) days after the Public Presentation to send in written comments to NEPA.

***(A typical agenda for a meeting is given in Appendix 2)***

## APPENDIX 1

### NOTIFICATION OF PUBLIC MEETING

THERE WILL BE A PUBLIC PRESENTATION ON THE ENVIRONMENT  
IMPACT ASSESSMENT REPORT

OF:

VENUE:

DATE:

TIME:

THE PUBLIC IS INVITED TO PARTICIPATE IN THE PRESENTATION BY WAY  
OF ASKING QUESTIONS RELATING TO THE PROPOSED PROJECT.

A COPY OF THE ENVIRONMENTAL IMPACT ASSESSMENT REPORT MAY  
BE CONSULTED AT THE

\_\_\_\_\_ PARISH LIBRARY  
\_\_\_\_\_ PARISH COUNCIL OFFICE

For further information contact:



## APPENDIX 3

### **ROLE AND RESPONSIBILITIES OF THE CHAIRPERSON**

The chairperson has the main role of guiding the conduct of the meeting and seeing to it that the concerns of the public are adequately aired and addressed by the proponent/consultants.

The responsibilities of the chairperson include explaining the NEPA approval process, that is, the steps involved and the role of the NEPA at these public presentations. In other words, the chairperson should explain the context within which the meeting is taking place.

The chairperson should ensure that adequate time is allowed for questions and answers, and must understand clearly and communicate the purpose of the meeting to the audience. The chairperson is responsible for introducing the presenters.

The chairperson should contribute to but not monopolize the meeting.



### Appendix 4 – QC-10 Noise Calibration Certificate

**3M Oconomowoc  
Personal Safety Division**

3M Detection Solutions  
1060 Corporate Center Drive  
Oconomowoc, WI 53066-4828  
www.3M.com/detection  
262 567 9157 800 245 0779  
262 567 4047 Fax

Page 1 of 2



### Certificate of Calibration

Certificate No: 5500556QII050083

**Submitted By:** C.L. ENVIRON. CO LTDA  
22 FORT GEORGE HEIGHTS  
KINGSTON, 9 JAMAICA

**Serial Number:** QII050083

**Date Received:** 8/12/2013

**Customer ID:**

**Date Issued:** 8/17/2013

**Model:** QC-10 CALIBRATOR

**Valid Until:** 8/17/2014

**Test Conditions:**

**Model Conditions:**

**Temperature:** 18°C to 29°C  
**Humidity:** 20% to 80%  
**Barometric Pressure:** 890 mbar to 1050 mbar

**As Found:** IN TOLERANCE  
**As Left:** IN TOLERANCE

**SubAssemblies:**

**Description:**

**Serial Number:**

**Calibration Procedure:**56V981

**Reference Standard(s):**

I.D. Number	Device
ET0000556	B&K ENSEMBLE
T00230	FLUKE 45 MULTIMETER

Last Calibration Date	Calibration Due
10/13/2012	10/13/2013
2/2/2012	2/2/2014

**Measurement Uncertainty:**

+/- 1.1% ACOUSTIC (0.1DB) +/- 1.4% VAC +/- 0.012% HZ  
Estimated at 95% Confidence Level (k=2)

**Calibrated By:** S. Vanhemert 8/17/2013  
SHAWN VANHEMERT Service Technician

**Reviewed/Approved By:** [Signature] 8/17/2013  
Technical Manager/Deputy

This report certifies that all calibration equipment used in the test is traceable to NIST or other NMI, and applies only to the unit identified under equipment above. This report must not be reproduced except in its entirety without the written approval of 3M Detection Solutions.

098-393 Rev. B

An ISO 9001 Registered Company  
ISO 17025 Accredited Calibration Laboratory



## Appendix 5 – Flora species listing

Species	Density/Hectare	SE	Species	Density/Hectare	SE
<i>Haematoxylum campechianum</i>	3655.8	572.4	<i>Calophyllum calaba</i>	9.3	9.302
<i>Chrysophyllum oliviforme</i>	944.2	153.1	<i>Capparis flexuosa</i>	9.3	7.301
<i>Eugenia sp.</i>	734.9	143.1	<i>Psychotria balbisisana</i>	9.3	5.582
<i>Acacia sp.</i>	581.4	90.3	<i>Eugenia maleolens</i>	7	5.15
<i>Polygala jamaicensis</i>	383.7	65.04	<i>Guazuma ulmifolia</i>	7	5.15
<i>Allophylus jamaicensis</i>	302.3	47.12	<i>Laetia thamnia</i>	7	6.977
<i>Leucaena leucocephala</i>	276.7	63.91	<i>Melicoccus bijugatus</i>	7	5.15
<i>Casearia hirsuta</i>	237.2	45.39	<i>Nectandra spp.</i>	7	6.977
<i>Brya ebenus</i>	207	114.8	<i>Prosopis juliflora</i>	7	5.15
<i>Cassia emarginata</i>	130.2	29.49	<i>Urechites lutea</i>	7	5.15
<i>Bunchosia media</i>	109.3	23.95	<i>Casearia sylvestris</i>	4.7	3.249
<i>Simarouba glauca</i>	107	23.86	<i>Mangifera indica</i>	4.7	3.249
<i>Bursera simaruba</i>	97.7	18.07	<i>Annona squamosa</i>	2.3	2.326
<i>Piscidia piscipula</i>	93	33.18	<i>Ateramnus lucidus</i>	2.3	2.326
<i>Capparis babduca</i>	90.7	88.35	<i>Bastard Maiden</i>	2.3	2.326
<i>Exothea paniculata</i>	72.1	48.83	<i>Calyptanthus sp.</i>	2.3	2.326
<i>Casearia nitida</i>	55.8	17.39	<i>Canella winterana</i>	2.3	2.326
<i>Malpighia glabra</i>	46.5	16.42	<i>Cecropia peltata</i>	2.3	2.326
<i>Manilkara zapota</i>	44.2	13.44	<i>Cordia brownie</i>	2.3	2.326
<i>Cassia viminea</i>	41.9	26.67	<i>Cordia laevigata</i>	2.3	2.326
<i>Cordia gerascanthus</i>	41.9	34.94	<i>Cordia linnaei</i>	2.3	2.326
<i>Bourreria sp.</i>	37.2	19.97	<i>Delonix regia</i>	2.3	2.326
<i>Celtis trinervia</i>	32.6	12.33	<i>Eupatorium oderatum</i>	2.3	2.326
<i>Erythroxylum confusum</i>	32.6	12.77	<i>Guettarda elliptica</i>	2.3	2.326
<i>Bumelia salicifolia</i>	30.2	9.135	<i>Metopium brownii</i>	2.3	2.326
<i>Samanea saman</i>	25.6	11.08	<i>Nectandra antillana</i>	2.3	2.326
<i>Fagara elephantiasis</i>	23.3	8.04	<i>Pithecellobium arboreum</i>	2.3	2.326
<i>Crescentia cujete</i>	11.6	7.595	<i>Prunus myrtifolia</i>	2.3	2.326
<i>Erythroxylum sp.</i>	11.6	5.962	<i>Solanum torvum</i>	2.3	2.326
<i>Malpighia sp.</i>	11.6	9.535			

**Abundance of Tree Species:**

Srl	Species/ Trees	Number of individuals	Srl	Species/ Trees	Number of individuals
1	<i>Haematoxylum campechianum</i>	482	29	<i>Erythroxylum sp.</i>	3
2	<i>Chrysophyllum oliviforme</i>	200	30	<i>Guazuma ulmifolia</i>	3
3	<i>Eugenia sp.</i>	103	31	<i>Laetia thamnina</i>	3
4	<i>Acacia sp.</i>	78	32	<i>Nectandra spp.</i>	3
5	<i>Allophylus jamaicensis</i>	68	33	<i>Psychotria balbisiana</i>	3
6	<i>Casearia hirsuta</i>	66	34	<i>Bourreria sp.</i>	2
7	<i>Polygala jamaicensis</i>	48	35	<i>Casearia sylvestris</i>	2
8	<i>Leucaena leucocephala</i>	47	36	<i>Eugenia maleolens</i>	2
9	<i>Cassia emarginata</i>	44	37	<i>Mangifera indica</i>	2
10	<i>Brya ebenus</i>	33	38	<i>Samanea saman</i>	2
11	<i>Bursera simaruba</i>	31	39	<i>Urechites lutea</i>	2
12	<i>Bunchosia media</i>	26	40	<i>Ateramnus lucidus</i>	1
13	<i>Piscidia piscipula</i>	26	41	<i>Bastard Maiden</i>	1
14	<i>Exothea paniculata</i>	18	42	<i>Capparis flexuosa</i>	1
15	<i>Manilkara zapota</i>	14	43	<i>Cecropia peltata</i>	1
16	<i>Bumelia salicifolia</i>	13	44	<i>Cordia brownie</i>	1
17	<i>Casearia nitida</i>	13	45	<i>Cordia laevigata</i>	1
18	<i>Simarouba glauca</i>	11	46	<i>Cordia linnaei</i>	1
19	<i>Malpighia glabra</i>	10	47	<i>Delonix regia</i>	1
20	<i>Celtis trinervia</i>	8	48	<i>Guettarda elliptica</i>	1
21	<i>Cordia gerascanthus</i>	8	49	<i>Melicoccus bijugatus</i>	1
22	<i>Capparis babduca</i>	7	50	<i>Metopium brownii</i>	1
23	<i>Bourreria sp.</i>	6	51	<i>Nectandra antillana</i>	1
24	<i>Cassia viminea</i>	5	52	<i>Pithecellobium arboreum</i>	1
25	<i>Erythroxylum confusum</i>	5	53	<i>Prosopis juliflora</i>	1
26	<i>Malpighia sp.</i>	5	54	<i>Prunus myrtifolia</i>	1
27	<i>Crescentia cujete</i>	4	55	<i>Solanum torvum</i>	1
28	<i>Fagara elephantiasis</i>	4			

**Seedling Abundance:**

Srl	Species/ Seedling	Number of individuals	Srl	Species/ Seedling	Number of individuals
1	<i>Haematoxylum campechianum</i>	1090	20	<i>Malpighia glabra</i>	10
2	<i>Eugenia sp.</i>	213	21	<i>Erythroxylum confusum</i>	9
3	<i>Chrysophyllum oliviforme</i>	206	22	<i>Samanea saman</i>	9
4	<i>Acacia sp.</i>	172	23	<i>Bourreria sp.</i>	8
5	<i>Polygala jamaicensis</i>	117	24	<i>Celtis trinervia</i>	6
6	<i>Leucaena leucocephala</i>	72	25	<i>Fagara elephantiasis</i>	6
7	<i>Allophylus jamaicensis</i>	62	26	<i>Manilkara zapota</i>	5
8	<i>Brya ebenus</i>	56	27	<i>Calophyllum calaba</i>	4
9	<i>Casearia hirsuta</i>	36	28	<i>Capparis flexuosa</i>	3
10	<i>Simarouba glauca</i>	35	29	<i>Erythroxylum sp.</i>	2

Srl	Species/ Seedling	Number of individuals	Srl	Species/ Seedling	Number of individuals
11	<i>Capparis babduca</i>	32	30	<i>Melicoccus bijugatus</i>	2
12	<i>Bunchosia media</i>	21	31	<i>Prosopis juliflora</i>	2
13	<i>Piscidia piscipula</i>	14	32	<i>Annona squamosa</i>	1
14	<i>Cassia viminea</i>	13	33	<i>Calyptanthes sp.</i>	1
15	<i>Exothea paniculata</i>	13	34	<i>Canella winterana</i>	1
16	<i>Cassia emarginata</i>	12	35	<i>Crescentia cujete</i>	1
17	<i>Bursera simaruba</i>	11	36	<i>Eugenia maleolens</i>	1
18	<i>Casearia nitida</i>	11	37	<i>Eupatorium oderatum</i>	1
19	<i>Cordia gerascanthus</i>	10	38	<i>Psychotria balbisisana</i>	1
			39	<i>Urechites lutea</i>	1

**List of Species - Shrubs, Vines and Grasses:**

Scientific Name	Common Name	Family	Status
<b>Shrubs</b>			
<i>Calyptanthes pallens</i>		Myrtaceae	Common
<i>Cordia linnaei</i>		Boraginaceae	Common
<i>Croton linearis</i>	Rosemary	Euphorbiaceae	Common
<i>Eupatorium odoratum</i>	Jack-in the bush	Asteraceae (Compositae)	Common
<i>Lantana camara</i>	Wild sage	Verbenaceae	Common
<i>Pisonia aculeata</i>	Cockspur	Nyctaginaceae	Common
<i>Sida acuta</i>	Broom weed	Malvaceae	Very common
<i>Stachytarpheta jamaicensis</i>	Vervaine, Porter weed	Verbenaceae	Very common
<i>Turnera ulmifolia</i>	Ram-goat Dash-along	Turneraceae	Common
<i>Helicteres jamaicensis</i>	Screw tree		Common
<b>Vines</b>			
<i>Abrus precatorious</i>	Crab eyes, John crow bead	Papilionaceae (Fabaceae)	Common
<i>Cissampelos pareira</i>	Velvet Leaf	Menispermaceae	Common
<i>Ipomoea sp.</i>		Convolvulaceae	Common
<i>Desmodium canum</i>	Sweetheart	Papilionaceae (Fabaceae)	Common
<i>Mimosa pudica</i>	Shame old lady	Mimosaceae	Common
<i>Momordica balsamina</i>	Ceracea	Cucurbitaceae	Very common
<i>Mucuna pruriens</i>	cowitch	Papilionaceae (Fabaceae)	Very common
<i>Passiflora suberosa</i>		Passifloraceae	Common
<i>Similax balbisisana</i>	Chainy Root	Smiacaceae	Common
<i>Stigmaphyllon emarginatum</i>		Malpighiaceae	
<b>Grass</b>			
<i>Lasiacis divaricta</i>	Bamboo	Gramineae (Poaceae)	Very common
<i>Panicum maximum</i>	Guinea grass	Cyperaceae	Occasional
<i>Scleria secans</i>	Razor grass	Cyperaceae	Common

**List of Tree Species:**

Scientific Name	Common Name	Family	Status
<i>Acacia sp.</i>	Macka	Mimosaceae	Common
<i>Allophylus jamaicensis</i>		Sapindaceae	
<i>Annona squamosa</i>	Sweet sop	Annonaceae	Common
<i>Ateramnus lucidus</i>	Crab Wood	Euphorbiaceae	Common
<i>Bourreria sp.</i>		Boraginaceae	Common
<i>Brya ebenus</i>	Ebony	Papilionaceae(Fabaceae)	Common
<i>Bumelia salicifolia</i>	Whit Bullet,Bully	Sapotaceae	Common
<i>Bunchosia media</i>		Malpighiaceae	Very Common
<i>Bursera simaruba</i>	Red Birch	Burseraceae	Common
<i>Calophyllum calaba</i>	Santa Maria	Guttiferae(Clusiaceae)	Common
<i>Calyptanthes sp.</i>		Myrtaceae	Locally Common/Endemic
<i>Canella winterana</i>	Wild Cinnamon	Canellaceae	Common
<i>Capparis babduca</i>		Capparaceae	Uncommon and Local (St Andrew, St Catherine, St Ann)
<i>Capparis flexuosa</i>	Bottle Cod Root	Capparaceae	Common
<i>Casearia hirsuta</i>	Wild Coffee, White Wattle	Flacourtiaceae	Common
<i>Casearia nitida</i>		Flacourtiaceae	Common
<i>Casearia sylvestris</i>		Flacourtiaceae	Common
<i>Cassia emarginata</i>	Stinking Pea, Senna Tree, Yellow Candle Wood	Caesalpiniaceae	Common
<i>Cassia viminea</i>		Caesalpiniaceae	Common
<i>Cecropia peltata</i>	Trumpet Tree	Moraceae	Common
<i>Celtis trinervia</i>	Bastard Fustic	Ulmaceae	Common
<i>Chrysophyllum oliviforme</i>	Wild Star Apple	Sapotaceae	Common
<i>Comocladia pinnatifolia</i>	Maiden plum	Anacardiaceae	Common
<i>Cordia brownie</i>	Black Sage	Boraginaceae	Common
<i>Cordia gerascanthus</i>	Spanish Elm,Panchallon	Boraginaceae	Common
<i>Cordia laevigata</i>		Boraginaceae	Common
<i>Cordia linnaei</i>		Boraginaceae	Common
<i>Crescentia cujete</i>	Callabash	Bignoniaceae	Common
<i>Delonix regia</i>	Poinciana	Caesalpiniaceae	Common
<i>Erythroxylum confusum</i>	Barberry Bullet	Erythroxylaceae	Common
<i>Erythroxylum sp.</i>		Erythroxylaceae	Common
<i>Eugenia maleolens</i>	Rod Wood	Myrtaceae	Common
<i>Eugenia sp.</i>	Rod Wood	Myrtaceae	Common
<i>Exothea paniculata</i>	Wild Guinep	Sapindaceae	Occasional to Central Parishes
<i>Fagara elephantiasis</i>	Yellow Sanders	Rutaceae	Common
<i>Guazuma ulmifolia</i>	Bastard Cedar	Sterculiaceae	Very Common
<i>Guettarda elliptica</i>	Velvet Seed	Rubiaceae	Common
<i>Haematoxylum campechianum</i>	Log Wood	Caesalpiniaceae	Common
<i>Laetia thamnina</i>	Scarlet Seed	Flacourtiaceae	Common
<i>Lantana camara</i>	Wild Sage	Verbenaceae	Very Common
<i>Leucaena leucocephala</i>	Lead Tree	Mimosaceae	Common
<i>Malpighia glabra</i>	Wild Cherry	Malpighiaceae	Common
<i>Malpighia sp.</i>		Malpighiaceae	Common



Scientific Name	Common Name	Family	Status
<i>Mangifera indica</i>	Mango	Anacardiaceae	Very Common
<i>Manilkara zapota</i>	Nesberry	Sapotaceae	Very Common
<i>Melicoccus bijugatus</i>	Guinep	Sapindaceae	Very Common
<i>Metopium brownii</i>	Burn Wood	Anacardiaceae	Common
<i>Nectandra antillana</i>	Yellow Sweet Wood	Lauraceae	Very Common
<i>Nectandra sp.</i>	Sweet Wood	Lauraceae	Common
<i>Piscidia piscipula</i>	Dog Wood	Papilionaceae(Fabaceae)	Common
<i>Pithecellobium arboreum</i>	Wild Tamarind	Mimosaceae	Common
<i>Polygala jamaicensis</i>	Whie Lignum vitae	Polygalaceae	Common
<i>Prosopis juliflora</i>	Cashaw	Mimosaceae	locally Common(St Andrew, St Catherine, Clarendon)
<i>Prunus myrtifolia</i>	Ants Wood	Cunoniaceae	Common
<i>Psychotria balbisisana</i>		Rubiaceae	Very Common
<i>Samanea saman</i>	Guango	Mimosaceae	Common
<i>Simarouba glauca</i>	Bitter Banson	Simaroubaceae	Common
<i>Solanum torvum</i>	Susumber	Solanaceae	Common
<i>Turnera ulmifolia</i>	Ram Goat Dashalong	Turnraceae	Common
<i>Urechites lutes</i>	Night Sage	Apocynaceae	Common

Table showing percentage cover of shrubs per plot:

Plot Number	Percentage Cover of Shrubs	Plot Number	Percentage Cover of Shrubs
1	90%	23	90%
2	80%	24	90%
3	95%	25	90%
4	90%	26	100%
5	80%	27	85%
6	85%	28	50%
7	85%	29	50%
8	85%	30	75%
9	80%	31	80%
10	100%	32	65%
11	80%	33	90%
12	50%	34	90%
13	35%	35	80%
14	30%	36	60%
15	40%	37	30%
16	80%	38	85%
17	20%	39	70%
18	60%	40	60%
19	65%	41	75%
20	50%	42	90%
21	80%	43	80%
22	90%		



### Dovecot Expansion Vegetation Profile (430 m)

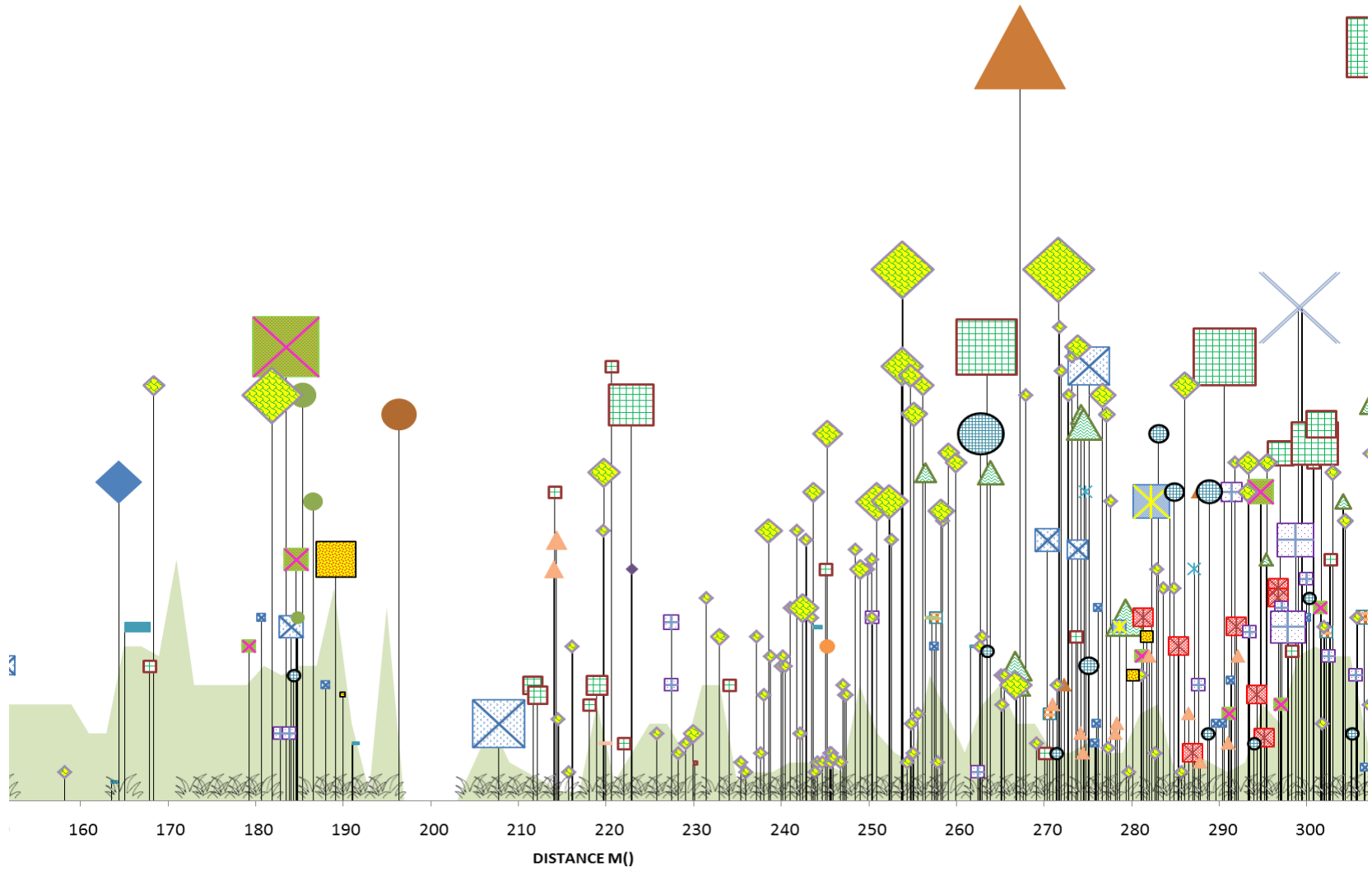

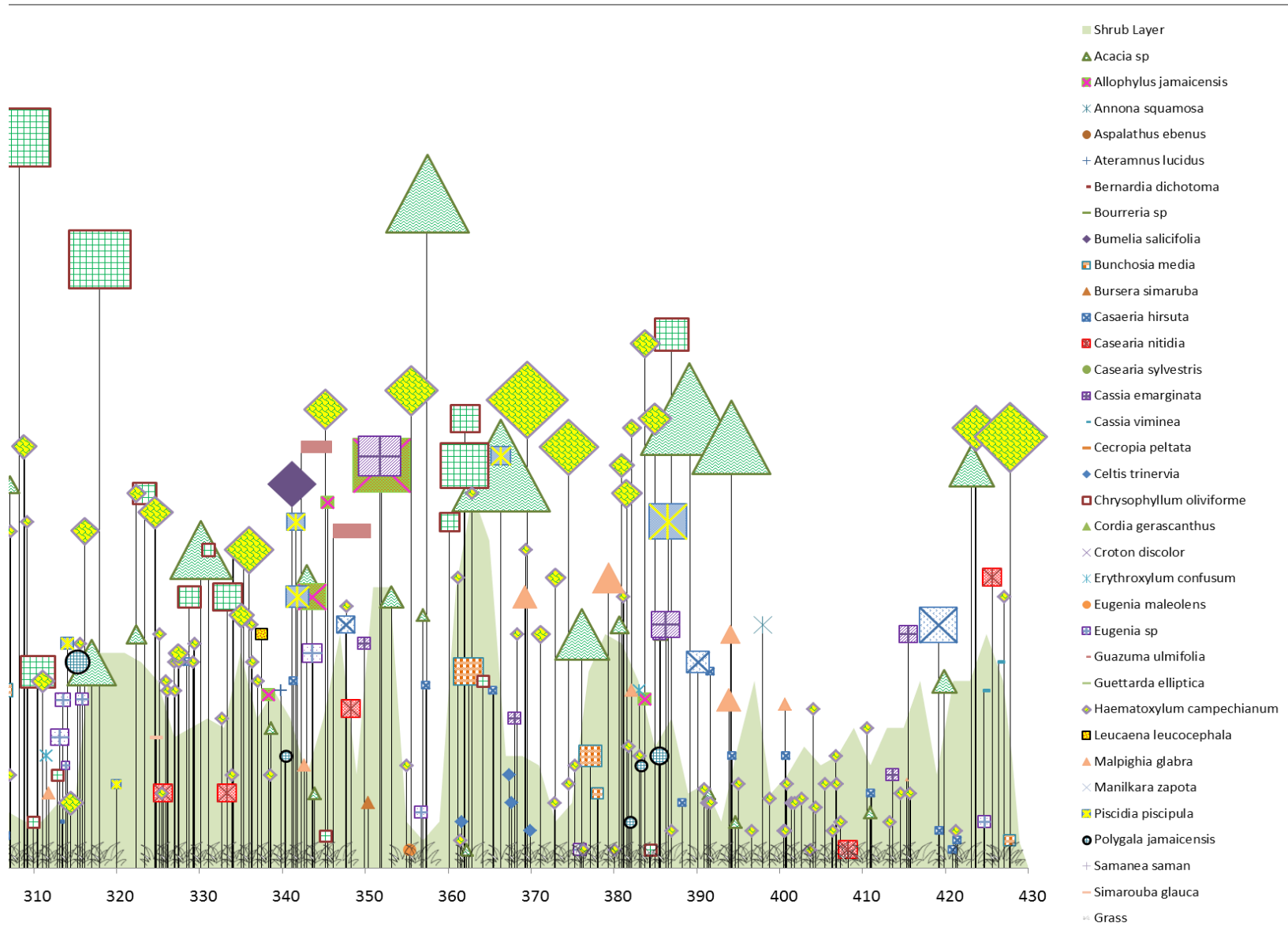

## Appendix 6 – WRA Technical Note

**Technical Note**  
**Hydrogeological Assessment**  
**Dovecot Memorial Park Expansion, Chisholm Bendon Pen, St. Catherine**

### **Background**

C.L. Environmental Company Limited has requested hydrogeological data for Chisholm Bendon Pen, St. Catherine on behalf of their client. Guidance was sought from the Water Resources Authority (WRA) with respect to a proposal to expand the existing Dovecot Memorial Park Cemetery by approximately 28.7 hectares. The risk posed by cemeteries includes the leaching of chemicals such as phenol, methanol and formaldehyde (used for preservation purposes) or the spread of contagious diseases into the groundwater system.

The results of a desk study of the area have been compiled in this technical note. The information relates to the estimated depth to groundwater, the extent and use of aquifers in the area, the probable direction of groundwater flow and gradient, location of any springs and surface water features and any potential impact on sources of local municipal water supply and location of registered private or industrial wells, including impacts on underground water quality.

### **Physical Setting**

The proposed expansion site is located approximately 500m west of the existing Dovecot Memorial Park. It is also approximately 1.27km west of Green Acres and approximately 7.20km west northwest of Spanish Town (Figure 1). The land use of the area is mostly residential with commercial agricultural activity occurring to the south. The area is characterized by gently sloping scarps and the elevation of the site ranges from 70m to 100m amsl above mean sea level (229.66ft-328.08ft).

Much of the sugar plantations in the area are being converted to residential developments due to declining yields and increased demand for housing. The Highway 2000 corridor in recent times has also acted as a catalyst for this rapid housing conversion.

### **Geology & Hydrogeology**

The proposed cemetery expansion is underlain by the Walderston-Brown's Town Limestone Formation which is characterised as massive, soft calcarenites and bedded microsparites. This white limestone is heavily faulted and exhibits extensive interconnectivity. Weathering over time has also produced secondary porosity which promotes increased groundwater flow, thus the limestone can be considered beneficial for the development of groundwater use in the area.

Due to the nature of the Walderston-Brown's Town Formation it is classified as a limestone aquifer (Figure 2). An aquifer is capable of storing and transmitting significant quantities of water under normal hydraulic conditions to a well or spring. Recorded local aquifer transmissivity in the Walderston-Brown's Town Formation is 940m<sup>2</sup>/day. The closest mapped faults to the site are approximately 2.13km north and 3.02km northeast trending in a west northwest, east southeast direction and a northeast, southwest direction respectively (Figure 2).



**Location Map of Dovecot Memorial Park, St. Catherine**

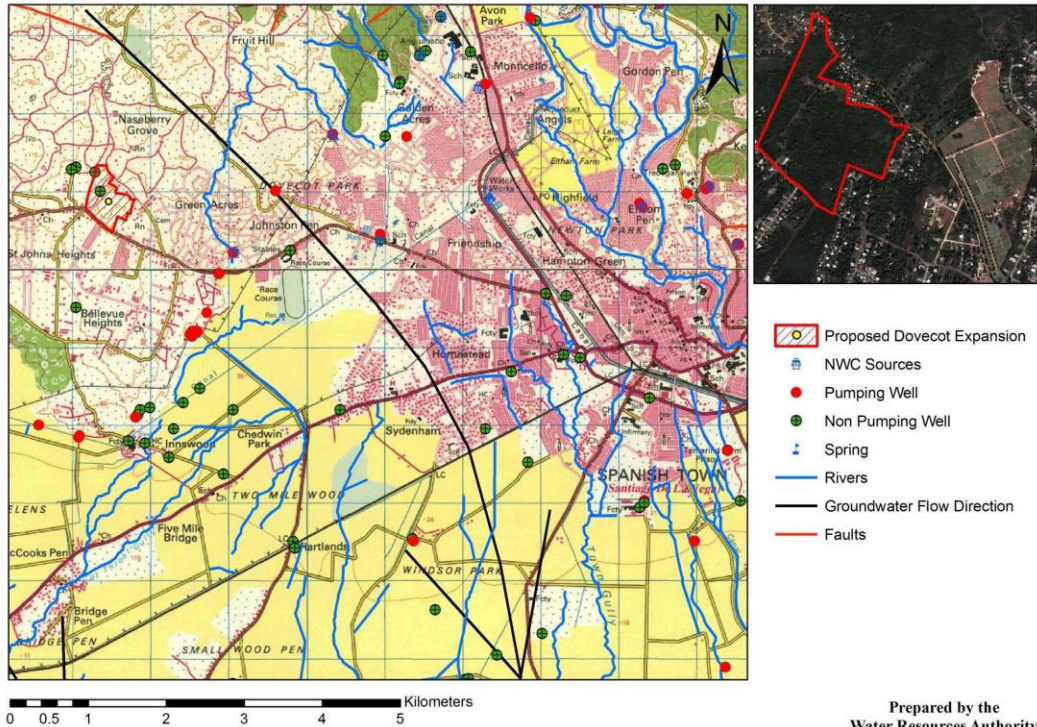

Figure 1: Showing the location of the Expansion Phase for the Dovecot Memorial Park, St. Catherine

Prepared by the  
Water Resources Authority  
September 2014

**Hydrostratigraphy Map of Dovecot Memorial Park, St. Catherine**

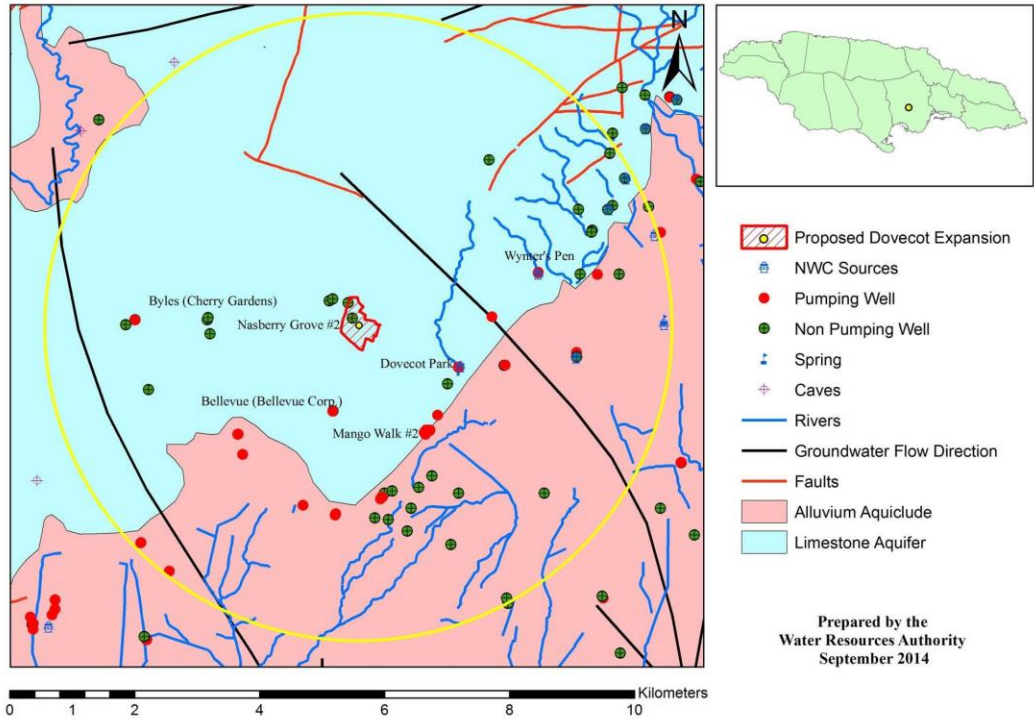

Figure 2: Showing the hydrostratigraphy of the area encompassing the Expansion Phase of the Dovecot Memorial Park, St. Catherine

### Soil Type

Borelogs of wells around this region indicate that the soil overburden is a clay loam. The lithology is a mixture of clay, clay and marl, marl and loam as well as bauxite soil (west) overlying the limestone aquifer. This soil is characterised by very rapid internal drainage and moderate to high erosion capacity. Borelogs of the Dovecot Park (St. John's Road, Green Acres) pumping well and the Byles (Cherry Gardens) replacement non-pumping well indicates that the thickness varies between 12.19m southeast of the site and 57.91m west of the site (40ft - 190ft). There are also discontinuous pockets of red clay interspersed with limestone at varying depths.

### Water Supply from Groundwater Resources

There has been substantial groundwater exploration in the area. Generally the limestone aquifer has proven to produce a high yield due to faulting and the development of secondary porosity. Groundwater flows in a south and south easterly direction towards the coast. The proposed property sits within the Rio Cobre River Hydrological Basin which has a reliable groundwater yield of  $337.7 \times 10^6 \text{m}^3/\text{yr}$  (337.7 million cubic meters per year - WRA Master Plan, 2005).

The closest pumping wells to the site are the Bellevue (Bellevue Corp.) and the Dovecot Park wells (Table 1). The closest non-pumping wells to the site are the Nasberry Grove #1 and the Nasberry Grove #2 wells (Table 2). The Green Acres well which is located 1.76km south east of the site and the Brown's well located 2.97km east north east of the site are both National Water Commission (NWC) production wells which provides a potable water supply to the Green Acres and Dovecot Park communities respectively (Figure 2).

The borelog lithologies of the Dovecot Park well (Table 1) and the Byles (Cherry Gardens) replacement well (Table 2) records the thickness of the limestone as ranging from approximately 53.34m (175ft) southeast of the site to approximately 76.2m (250ft) west of the site (Figure 2). It is important to note that no well has been drilled through the limestone formation to its base.

Groundwater level data for the Mango Walk #2 pumping well (Table 1) and the Nasberry Grove #2 non-pumping well (Table 2) indicates that the depth to groundwater for the region ranges between 21.71m BGL (below ground level) to 60.76m BGL in 2014.

Groundwater abstraction for the Dovecot Park and the Wynters Pen (BWC) pumping wells (2.98km east) are  $141.12 \text{m}^3/\text{day}$  and  $52.40 \text{m}^3/\text{day}$  in 2013 respectively. These wells both supply domestic water for the communities of Green Acres, Johnston Pen and Dovecot Park respectively.

This area represents a major ground water pumping depression within which groundwater levels were historically below sea level. These groundwater levels were theorised to be as a result of the general mining of the ground water resources in the basin. As such a moratorium has been enforced by WRA which restricts the development of new wells in the Lower Rio Cobre Basin.

**Table 1: Pumping wells within a 2.5km radius of the Dovecot Memorial Park Expansion**

Well Name	Distance From	Well Use	Coordinates	Owner
Bellevue	1.47Km SSW	Irrigation	E 747151 N 649800	Bellevue Co-op
Dovecot Park St. John's Road Green Acres	1.73km SE	Public Supply	E 749166 N 650508	De La Vega Investments
Mango Walk # 1	1.91km SE	Irrigation	E 748835 N 649745	Inswood Estates
Mango Walk # 5	1.99km SSE	Irrigation	E 748644 N 649501	Inswood Estates
Mango Walk # 4	2km SSE	Irrigation	E 748623 N 649468	Inswood Estates
Mango Walk # 3	2.02km SSE	Irrigation	E 748707 N 649501	Inswood Estates
Fraser's Content	2.14km E	Public Supply	E 749715 N 651295	Kemtek Development and Construction Ltd.
St. Johns Road Melvin Park	2.39km SE	Public Supply	E 749914 N 650641	Black Brother's Incorporation
Mango Walk # 2	2.43km SSE	Irrigation	E 748638 N 649432	Inswood Estates

**Table 2: Non-Pumping wells within a 2.5km radius of the Dovecot Memorial Park Expansion**

Well Name	Distance From	Well Use	Coordinates	Owner
Nasberry Grove # 1	On Site	Monitoring	E 747394 N 651538	G. Kingsley Rose
Nasberry Grove # 2	On Site	Monitoring	E 747463 N 651287	G. Kingsley Rose
Nasberry Grove	1.56km W	Monitoring	E 747150 N 651598	G. Kingsley Rose
Bellevue Corehole	1.73km SE	Monitoring	E 748989 N 650236	Mr. Harold Williams
Byles Corehole	2.40km W	Monitoring	E 745182 N 651040	Jamaica Public Service Company Ltd.
Byles (Cherry Gardens) replacement	2.43km W	Monitoring	E 745151 N 651298	National Water Commission

**Water Supply from Surface Resources**

The area is mostly devoid of surface drainage due to the karstic nature of the underlying white limestone, thus surface water is readily lost through sink holes to the groundwater system. Further south of the proposed cemetery development however, where the white limestone comes into contact with the alluvial deposits (clayey materials) of the alluvium aquiclude, groundwater is discharged to the surface via springs that give rise to numerous streams which flow south towards the coast.

The Rio Cobre River Hydrological Basin receives a total mean annual rainfall of 1250mm/yr. This hydrological basin thus has the capacity to produce a reliable surface water yield of  $146 \times 10^6 \text{m}^3/\text{yr}$  (WRA Master Plan, 2005). For this reason the Rio Cobre River which is baseflow controlled can be considered as an important economic resource in the region. An unidentified surface water feature/canal is located approximately 1.28km east of the site. Several ephemeral streams and irrigation canals exist within a 5km radius of the site (Figure 2).

**Flood Potential**

The WRA is unaware of flooding in the area however, it is important to note that a depression lies at the centre of the proposed development (Figure 3). This coupled with the nature of the soil cover can lead to ponding of surface water run-off and flooding at the site, whereby the standing water has a greater chance to pick up pollutants before it is infiltrated. Also the Nasberry Grove #1 and #2 wells can be affected should the site become inundated by flood water.

**Location Map of Dovecot Memorial Park, St. Catherine**

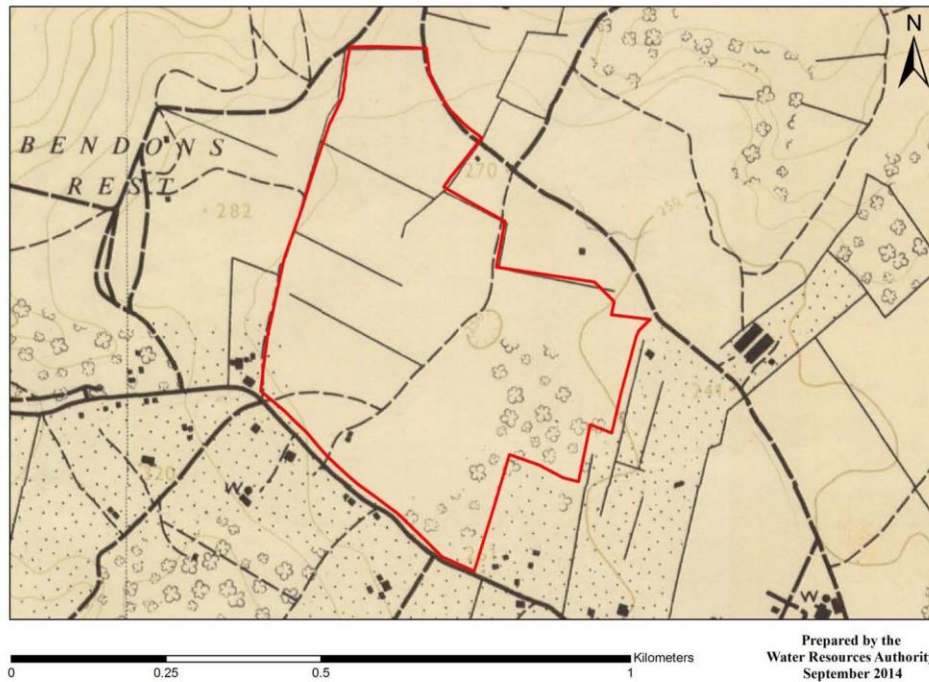

Figure 3: Showing the location of the mapped depression which lies within the expansion phase.



### **Conclusion**

The estimated depth to groundwater where the proposed cemetery will be developed is fairly shallow (21.71m – 60.76m BGL). The limestone aquifer is tapped by NWC and various business entities for public supply as well as irrigation purposes for the agricultural lands located south of the site. Additionally, the groundwater from this region is important for recharge to the springs and streams south of the site.

Due to the karst development and the fact that the soil overburden displays very rapid internal drainage there may be increased risk of contaminants reaching the water table. Contaminated surface run-off can be transported laterally to areas with lower hydraulic heads or vertically to the water table.

The water quality of any wells down gradient of the site such as the Mango Walk wells would therefore be vulnerable, due to the direction of groundwater flow and the fact that these wells sit at a lower elevation than the site (Figure 2). The Mango Walk wells range in elevation from 27.19m to 28.30m amsl. This would have significant impacts on the supply of irrigation water for the sugar cane industries and horse farms within the agricultural plains to the south.

The water levels and water quality for the Mango Walk wells has been declining over time. There has been some improvement in these conditions in recent times due to the moratorium and reduction in pumping from the Lower Rio Cobre Basin.

If necessary the water levels within the depression associated with normal and extreme rainfall events should be determined. Based on this determination appropriate setbacks as well as an appropriate storm runoff drainage plan should be implemented which will adequately accommodate on site drainage and mitigate the impacts of site generated runoff.

**Prepared by:**  
**Nia Ramsoogoon**  
**Assistant Hydrologist**

## Appendix

### **Proposed Criteria for the Siting of Cemeteries**

#### **1. Cemeteries should be sited on lands which are well drained.**

- Cemetery sites should be characterized by slopes/gradients not less than 2% to avoid the ponding or settling of water.
- No cemetery or individual burial pit should be sited in depressions.
- Surface runoff from lands adjacent to the site should be intercepted by appropriately designed drains and directed away from the cemetery site.
- Site generated surface runoff should be efficiently conveyed off site by appropriately designed drains.
- Receiving drains outside the cemetery site must be adequate to avoid flooding of down gradient settlements.
- Cemeteries must not be sited within the 1 in 100 year return period floodplain boundary.
- Cemetery sites should not be traversed by any water courses, springs, rivers (intermittent or perennial), streams or gullies.

#### **2. Proximity to Major Faults and Groundwater Recharge Areas**

- Cemeteries should not be situated on major faults which are likely to function as direct conduits to the groundwater table.
- Cemeteries should not be situated atop Critical Recharge Areas.

#### **3. Distance from Water Resources**

Springs and water courses

- The outer boundary or perimeter of the cemetery site must be at least 250m away from any spring or water course.

#### **4. Production Wells**

- The outer boundary or perimeter of the cemetery site must be at least 500m away from any production well.

#### **5. Wetlands and Estuaries**

- The cemetery should not be sited within **500m** up-gradient of a wetland or estuary.

##### **Coastal/Marine Environment**

- The outer boundary or perimeter of the cemetery site must be at least **500m** away from the coastal/marine environment.

#### **6. Thickness of Soil Layer**

- All individual burial pits must maintain a minimum of 1m of unsaturated subsoil/alluvium below the bottom of the burial pit before encountering bedrock.
- Burial pits must be backfilled as soon as remains are interred and provide a minimum of 1m soil cover at the surface.

#### **7. Distance to Groundwater Table**

##### **In Alluvial Material**

- Base of all burial pits must maintain a minimum clearance of 1m above the highest natural water table (in alluvial material). (Variation of the water table must be evaluated to determine the highest levels).

##### **Thickness of Soil Layer**

- The proposed cemetery should be sited in areas having a thick soil layer for the burial pits to maintain a minimum of 1m of unsaturated subsoil/alluvium below the bottom of the burial pit before encountering bedrock and minimum of 1m soil cover at the surface.
- Burial pits must be backfilled as soon as remains are interred and provide a minimum of 1m soil cover at the surface.

## Appendix 7 – Questionnaires

### KUMANDA PARK LIMITED PROPOSED DEVELOPMENT TO EXPAND THE DOVECOT MEMORIA PARK, ST CATHERINE, JAMAICA

#### COMMUNITY QUESTIONNAIRE

DATE: \_\_\_\_\_

LOCATION: \_\_\_\_\_

Kumanda Park Limited is currently proposing an expansion of operation for the Dovecot Memorial Park off St. Johns Road in St. Catherine. The new 71acre property is to be developed to accommodate 48,120 burial vaults and sanitary facilities. The existing Bendon Seventh Day Adventist church will remain and 17,520sq m. of internal road ways will be put in place as the main artery of the property. It is proposed that National Water Commission supply the site with potable water as is being currently done. Additionally the proposed sewage treatment for new expansion is by use of Septic Tank and Evapotranspiration Bed. Access to the site will be for the project will be the existing access to the cemetery. The new project will maintain the existing natural drainage conditions. Hard scape (paved) areas such as roads and parking lot will capture surface water via curb and channel and deposit in soak wells.

#### COHORT DESCRIPTION

1. (i) Male (ii) Female
2. Age group (i) < 20 yrs (ii) 20- 29 yrs (iii) 30-39 yrs (iv) 40-49 yrs (v) 50 – 59 yrs (vi) older than 65 yrs
3. How long have you lived in this area? (i) 0 - 5 yrs.; (ii) 6 - 11 yrs.; (iii) 12 - 17 yrs.; (iv) 18 - 24 yrs.; (v) Over 24 yrs.

#### PERCEPTION

1. Have you ever heard of a company called Kumanda Park Limited? (i) yes; (ii) no
  - a. If yes what have you heard \_\_\_\_\_
  - b. How did you hear? (i) newspaper; (ii) television (iii) radio (iv) community meeting (v) word of mouth (vi) other
2. Did you know that the Kumanda Park Limited is proposing to extend the Dovecot Memorial Park located off St. Johns Road in St Catherine? (i) yes; (ii) no
  - a. If yes how were you made aware? (i) newspaper; (ii) television (iii) radio (iv) community meeting (v) word of mouth (vi) other
3. Do you think that the proposed site located off St. Johns Road is an accessible location? (i) yes; (ii) no
  - a. If yes why? \_\_\_\_\_
  - b. If no why? \_\_\_\_\_
4. Do you know of any other cemetery in the nearby area? (i) yes; (ii) no
  - a. If yes what is the name and how far away is it? \_\_\_\_\_
  - b. If yes do you know if that facility impacts (positively or negatively) nearby communities? \_\_\_\_\_
5. Do you know if existing public or private cemetery capacity nearby will soon be exhausted? (i) yes; (ii) no
6. Have you had deaths in your family? (i) yes; (ii) no
  - a. Were your loved ones (i) buried or (ii) cremated?
  - b. Were they buried at (i) public cemetery \_\_\_\_\_ (ii) private cemetery \_\_\_\_\_ (iii) family plot
7. Do you have any concerns about the project as proposed? (i) yes; (ii) no
  - a. If yes what are they? \_\_\_\_\_

- 8. Do you think this project will affect your life (i) positively; (ii) negatively; (iii) not at all; (iv) not sure
  - a. If positive/negative how \_\_\_\_\_
- 9. Do you depend on the proposed location for any type of business/farming/ residence? (i) yes; (ii) no
  - a. If yes for what purpose and how? \_\_\_\_\_
  - b. How much per week would you lose if you could not use the land? (i) \$0 - \$5,000; (ii) \$5,000 – \$10,000; (iii) more than \$10,000
- 10. Does anyone you know depend on the proposed location for any type of business/farming/residence? (i) yes; (ii) no
  - a. If yes for what purpose and how? \_\_\_\_\_

**NATURAL HAZARDS & SOCIAL AMENITIES**

- 11. Do you have any problems with domestic/household water supply (i) yes (ii) no
  - a. If yes what is the problem? (i) no water at all (ii) no pipes run to the area (iii) irregular water supply (iv) low water pressure (v) other \_\_\_\_\_
  - b. If yes how do you cope with the problem (i) collect rain water (ii) buy water (iii) collect water from a spring/river (iv) water truck supplies water (v) other \_\_\_\_\_
  - c. How do you store water (i) drums and other containers (ii) underground tank (iii) aboveground tank (iv) other \_\_\_\_\_
- 12. Is your community affected by flooding (i) yes; (ii) no
  - d. If yes how? \_\_\_\_\_
- 13. Is the proposed project site affected by flooding (i) Yes (ii) No
  - e. If yes how? \_\_\_\_\_
  - f. How frequently does flooding occur? (i) once per week (ii) once per month (iii) once every 3 months (iv) once every 6 months (v) other \_\_\_\_\_ (how often)
- 14. How high does the water level rise at the proposed site? (i) less than 0.3m (1ft); (ii) 0.3 – 1.0m (1– 3ft); (iii) 1.0 – 1.5m (3 – 5ft) (iv) greater than 1.5m (5ft)
- 15. Are there problems with frequent fires at the proposed site? (i) yes (ii) no
  - g. If yes how frequently does fires occur? (i) once per week (ii) once per month (iii) once every 3 months (iv) once every 6 months (v) other \_\_\_\_\_ (how often)
- 16. Is there anything in particular about your area that you would like to tell us?  
\_\_\_\_\_

Signature of Interviewer: .....